

Final Report

On the accident on **1st June 2009**
to the **Airbus A330-203**
registered **F-GZCP**
operated by **Air France**
flight AF 447 Rio de Janeiro - Paris

BEA

Ministère de l'Écologie, du Développement durable, des Transports et du Logement

Bureau d'Enquêtes et d'Analyses
pour la sécurité de l'aviation civile

Safety Investigations

BEA investigations are conducted in accordance with the provisions of Regulation No 996/2010 of the European Parliament and of the Council of 20 October 2010 on the investigation and prevention of accidents and incidents in civil aviation.

The BEA is the French Civil Aviation Safety Investigation Authority. Its investigations are conducted with the sole objective of improving aviation safety and are not intended to apportion blame or liability. BEA investigations are independent, separate and are conducted without prejudice to any judicial or administrative action that may be taken to determine blame or liability.

SPECIAL FOREWORD TO ENGLISH EDITION

This report has been translated and published by the BEA to make its reading easier for English-speaking people. As accurate as the translation may be, the original text in French is the work or reference.

Table of Contents

SAFETY INVESTIGATIONS	1
TABLE OF FIGURES	7
GLOSSARY	11
SYNOPSIS	17
ORGANISATION OF THE INVESTIGATION	19
1 - FACTUAL INFORMATION	21
1.1 History of Flight	21
1.2 Killed and Injured	24
1.3 Damage to Aircraft	24
1.4 Other Damage	24
1.5 Personnel Information	24
1.5.1 Flight crew	24
1.5.2 Cabin crew	29
1.6 Aircraft Information	30
1.6.1 Airframe	30
1.6.2 Engines	30
1.6.3 Weight and balance	30
1.6.4 Condition of the aircraft before departure	31
1.6.5 Maintenance operations follow-up	31
1.6.6 Information on the airspeed measuring system	31
1.6.7 Checks and maintenance of the Pitot probes	33
1.6.8 Radio communications system	34
1.6.9 Systems function	35
1.6.10 Specific points on overspeed	42
1.6.11 Angle of attack protection and stall warning	43
1.6.12 REC MAX and OPTI flight levels	45
1.6.13 Onboard weather radar	45
1.7 Meteorological Conditions	46
1.7.1 Meteorological situation	46
1.7.2 Forecast charts	46
1.7.3 Meteorological analyses	47
1.8 Aids to Navigation	48
1.9 Telecommunications	48
1.9.1 Communications between the aeroplane and the ATC centres	48
1.9.2 Means of monitoring used by air traffic control services	49
1.9.3 Coordination between the control centres	52
1.10 Aerodrome Information	53
1.11 Flight Recorders	53
1.11.1 Flight recorder opening operations and read-out	54
1.11.2 Analysis of the flight recorder data	57
1.11.3 Analysis of computers	62

1.12 Wreckage and Impact Information	64
1.12.1 Localisation of the floating debris and the wreckage site	64
1.12.2 Work performed on floating debris	66
1.12.3 Examination of the wreckage	77
1.12.4 Summary	81
1.13 Medical and Pathological Information	81
1.14 Fire	81
1.15 Survival Aspects and SAR	81
1.16 Tests and Research	83
1.16.1 Underwater search and recovery operations	83
1.16.2 Study of unreliable indicated airspeed events (temporary loss or anomalies) occurring in cruise on Airbus A330/A340	85
1.16.3 Analysis of functioning of systems	88
1.16.4 Analysis of aircraft performance	90
1.16.5 Reconstruction of the information available to the crew	93
1.16.6 Simulation of flight AF 447 in the Eurocat system	99
1.16.7 Aspects relating to fatigue	100
1.16.8 Work on Human Factors	101
1.16.9 Examination of the cockpit seats	106
1.17 Information on Organisations and Management	110
1.17.1 Organisation of Air France	110
1.17.2 Organisation of oversight of the operator by the DGAC	126
1.17.3 Air traffic services for a trans-oceanic flight	129
1.17.4 Search and Rescue (SAR)	130
1.18 Additional Information	136
1.18.1 Type Certification and continuing airworthiness	136
1.18.2 Information supplied to flight crews on the unreliable IAS situation	147
1.18.3 Information on the Stall	150
1.18.4 Simulator fidelity	154
1.18.5 Testimony	157
1.18.6 Previous Accidents and Recommendations	159
1.19 Useful or Effective Investigation Techniques	162
1.19.1 Resources used for phase 4	162
1.19.2 Resources used for phase 5	166
2 - ANALYSIS	167
2.1 Accident Scenario	167
2.1.1 From the beginning of the CVR recording until the autopilot disconnection	167
2.1.2 From the autopilot disconnection to triggering of the STALL 2 warning	171
2.1.3 From the triggering of the STALL 2 warning until the end of the flight	178
2.2 Pilot Training and Recurrent Training	182
2.2.1 Manual aeroplane handling and functional representation of flight	183
2.2.2 CRM training and exercises	184
2.2.3 Augmented crews	184
2.2.4 Flight simulators	185
2.2.5 Aeroplane behaviour in reconfiguration laws	186
2.3 Ergonomics	187
2.3.1 ECAM	187
2.3.2 Operation of the flight directors	188
2.3.3 Stall warning (operation and identification)	189

2.4 Operational and technical feedback	190
2.5 Oversight of the Operator by the national aviation safety authority (DGAC/DSAC)	192
2.6 SAR operations	193
2.7 Radio-communications with control services	194
2.7.1 Controllers' and crew's planned actions	194
2.7.2 Limits on the use of the Eurocat system in Senegal	194
2.7.3 Alert service provision	195
2.8 Lessons learnt from the search for the wreckage of flight AF 447	195
3 - CONCLUSION	197
3.1 Findings	197
3.2 Causes of the Accident	199
4 - SAFETY RECOMMENDATIONS	203
4.1 Recommendations from Interim Report n°2	203
4.1.1 Flight Recorders	203
4.1.2 Certification	204
4.2 Recommendations from Interim Report n°3	204
4.2.1 Recommendations on Operations	204
4.2.2 Recommendation relating to Certification	205
4.2.3 Recommendations relating to Flight Recorders	205
4.2.4 Recommendations relating to Transmission of Flight Data	206
4.3 New Recommendations	207
4.3.1 SAR coordination plans over maritime and remote areas	207
4.3.2 Training of SAR operators	207
4.3.3 Organisation of SAR in France	208
4.3.4 Air Traffic Control	208
4.3.5 Initial and recurrent training of pilots	208
4.3.6 Improving flight simulators and exercises	210
4.3.7 Ergonomics	210
4.3.8 Operational and Technical Feedback	212
4.3.9 Oversight of the Operator	212
4.3.10 Release of Drift Measuring Buoys	213
5 - CHANGES MADE FOLLOWING THE ACCIDENT	215
5.1 Air France	215
5.1.1 Aeroplane maintenance and equipment	215
5.1.2 Modifications to reference systems	215
5.1.3 Crew training	215
5.2 Airbus	216
5.3 EASA	216
5.3.1 Certification measures to improve aviation safety	216
5.3.2 Rulemaking actions from EASA to improve aviation safety:	216
5.4 Aviation industry actions	217
LIST OF APPENDICES	219

Table of figures

Figure 1: Flight profile	23
Figure 2: Position of the Pitot probes on the Airbus A330	32
Figure 3: Pitot probe (with protection caps)	32
Figure 4: Diagram of the speed measurement system architecture	33
Figure 5: FCU display	37
Figure 6: PFD in normal law	39
Figure 7: PFD in alternate 2 law	39
Figure 8: Pitot probe diagram	40
Figure 9: Overview	41
Figure 10: Effect of a drop in total measured pressure on standard altitude and vertical speed	42
Figure 11: Evolution of stall warning threshold in relation to Mach	44
Figure 12: Example of a "PROG" page from FMS	45
Figure 13: TEMSI chart overlaid with infrarouge image at 0 h 00	47
Figure 14: Strip filled out by ATLANTICO controller	49
Figure 15: Representation of air traffic by the Eurocat system	51
Figure 16: FDR	54
Figure 17: CVR	54
Figure 18: FDR CSMU after removal of cover	54
Figure 19: FDR memory board	55
Figure 20: Removal of internal protective layers	55
Figure 21: Opening of CVR CSMU	56
Figure 22: CVR memory board after removal of thermal protections	56
Figure 23: CVR memory boards before cleaning	56
Figure 24: Level of turbulence observed during flight	58
Figure 25: Position and detail of "AIR DATA" selector	59
Figure 26: Parameters from 2 h 10 min 04 to 2 h 10 min 26	60
Figure 27: Parameters from 2 h 10 min 26 to 2 h 10 min 50	61
Figure 28: Parameters from 2 h 10 min 50 to 2 h 11 min 46	62
Figure 29: Optical disk showing the location of the readable zones	63
Figure 30: Memory component from one of the FCDC	64
Figure 31: All of floating debris (found between 6 and 26 June), last known position and wreckage site	65
Figure 32: Wreckage localisation	66
Figure 33: Position of the recovered parts (exterior and cargo)	66
Figure 34: Position of the cabin part debris recovered in relation to the aircraft layout	67
Figure 35: Part of Galley G3: downwards deformation at the level of the galley's heavy parts	68
Figure 36: Luggage rack fitting deformed towards the front Toilet door (L54)	68
Figure 37: Metallic stiffeners deformed by buckling	68
Figure 38: Floor of the LDMCR: with bottom-upwards deformation	69
Figure 39: Ceiling of the LDMCR: with top-downwards deformation	69
Figure 40: Passenger oxygen container recovered closed: the deformations on the cover matched those on the box	69
Figure 41: Passenger oxygen container recovered open: the three pins are in place	70

Figure 42: Flap extension mechanism (or flap track) No. 3 in retracted position	70
Figure 43: Part of the No. 3 flap track fairing on the left wing	71
Figure 44: Fin – In the foreground the base of the fin with the central and forward attachment lugs	71
Figure 45: Rib 2 bent upwards as a result of bottom-upwards compression loads	72
Figure 46: HF antenna support	72
Figure 47: Arm 36G, right view: failure of the rudder attachments	73
Figure 48: Frame 87: shearing of the frame and fuselage skin along the frame	74
Figure 49: Right-hand aft lug: shearing of the fuselage along main frames 86-87	74
Figure 50: Frames 84 to 87: S-shaped deformation of frame 87, with frames 84 and 85 pushed in backwards; failure of the horizontal stabiliser actuator supports between frames 86 and 87 (red circle)	75
Figure 51: Fin centre and aft attachments	75
Figure 52: Rear view of the left-hand aft lug: there were marks showing a backwards pivoting of frames 86 and 87	76
Figure 53: Tensile failure of the centre spar at the level of the attachment of the lateral load pick-up rods	76
Figure 54: Compression failure of the aft spar at the level of the attachments of the lateral load pick-up rods and failure of the left-hand rod by buckling	77
Figure 55: Sonar Images of the debris field	77
Figure 56: Parts of the fuselage	78
Figure 57: Left engine air intake	78
Figure 58: Engine pylon	79
Figure 59: Cartography of the parts subsequently brought to the surface	79
Figure 60: Front view of engine	80
Figure 61: Trimmable horizontal stabiliser screwjack after being raised on board	80
Figure 62: Evolutions of recorded angles of attack and of the stall warning trigger threshold	89
Figure 63: Comparison between the recorded positions of the elevator and THS and the simulation	90
Figure 64: Comparison between altitudes of the aeroplane and the simulation (longitudinal axis)	91
Figure 65: Flight envelope	92
Figure 66: Evolution of normal acceleration - recorded at the time of activation of the stall warning	92
Figure 67: Speed displays on the PFD	93
Figure 68: Evolution of the 3 CAS	94
Figure 69: Evolution of FD crossbars	96
Figure 70: Position of the area where ECAM messages are displayed	97
Figure 71: ECAM displays at different moments (if no message has been erased)	97
Figure 72: Evolution of the REC MAX (simulation) Source Airbus	99
Figure 73: Source: Airbus FCOM supplied to Air France	103
Figure 74: Source FCOM Airbus	104
Figure 75: Source TU Air France	104
Figure 76: View of the cockpit seats	106
Figure 77: General view of the left seat	106
Figure 78: The seat's horizontal position adjustment systems	107
Figure 79: Right seat armrest on the side-stick side	108
Figure 80: Roller marks on the guidance rail	108
Figure 81: Right side seat cushion	109

Figure 82: Marks on the adjustment mechanism	109
Figure 83: Dial indicating armrest position	110
Figure 84: Malformation of the crotch belt fastening	110
Figure 85: A typical display on a flight logging interface	111
Figure 86: Strip created after coordination between ATLANTICO and DAKAR Océanic	129
Figure 87: Arrangement of the SRR in metropolitan France	133
Figure 88: Lift graph with high and low Mach	150
Figure 89: Flight envelope at high altitude	151
Figure 90: Alucia	163
Figure 91: AUV REMUS 6000	163
Figure 92: General view using sonar imaging: 120 kHz, range of 700 m	163
Figure 93: Engine	164
Figure 94: Wing	164
Figure 95: Section of fuselage	164
Figure 96: Landing gear	165
Figure 97: Overlay of sonar images taken with various settings: 120 kHz, 700 m range scale - 410 kHz, 100 m range scale - 410 kHz, 50 m range scale	165
Figure 98: Visualisation of the photo mosaic obtained with REMUS AUV images and the aeroplane debris identified by using the REMORA ROV	166

Glossary

A/THR	Auto Thrust
AAIB	Air Accident Investigation Branch (UK)
AC	Advisory Circular
ACARS	Aircraft Communication Addressing and Reporting System
ACC	Area Control Centre
ACJ	Advisory Circular Joint
ACP	Audio Control Panel
AD	Airworthiness Directive
AD	Airworthiness Directive
ADIRU	Air Data Inertial Reference Unit
ADM	Air Data Module
ADR	Air Data Reference
ADS-B	Automatic Dependant Surveillance-Broadcast
ADS-C	Automatic Dependant Surveillance-Contract
AIP	Aeronautical Information Publication
AIRAC	Aeronautical Information Regulation And Control
AMC	Acceptable Means of Compliance
AMU	Audio Management Unit
AOA	Angle Of Attack
AOC	Air Operator's Certificate
AP	Autopilot
APU	Auxiliary Power Unit
ARCC	Aeronautical Rescue Coordination Centre
ARM	Airworthiness Review Meeting
ASR	Air Safety Report
ATC	Air Traffic Control
ATIMS	Air Traffic and Information Management System
ATL	Aircraft Technical Log
ATPL	Airline Transport Pilot Licence
ATSB	Australian Transport Safety Bureau
ATSU	Air Traffic Service Unit
AUV	Autonomous Underwater Vehicle
BFU	Bundesstelle für Flugunfalluntersuchung (German investigation authority)
CAA	Civil Aviation Authority
CAS	Calibrated Air Speed
CAT	Clear Air Turbulence
CCQ	Cross Crew Qualification
CENIPA	Centro de Investigação e Prevenção de Acidentes aeronáuticos (Brazilian investigation authority)

CFR	Current Flight Report
CINDACTA	Centro Integrado de Defesa Aérea e Controle de Tráfego Aéreo (Integrated central air traffic and defence centre)
CMC	Central Maintenance Computer
CPDLC	Controller-Pilot Data Link Communications
CPL	Commercial Pilot Licence
CRM	Crew Resource Management
CSMU	Crash Survivable Memory Unit
CVR	Cockpit Voice Recorder
DDP	Declaration of Design and Performance
DECEA	Departamento de Controle do Espaço Aéreo (airspace control department)
DGA	Direction Générale de l'Armement (French armaments directorate)
DGAC	Direction Générale de l'Aviation Civile (French CAA)
DOA	Design Organisation Approval
DSAC	Direction de la Sécurité de l'Aviation Civile (French civil aviation safety department)
DSAC/NO	Direction de la Sécurité de l'Aviation Civile / Navigation et Opérations (French civil aviation safety department – navigation and ops)
DSAC-IR	Direction de la Sécurité de l'Aviation Civile Inter-Régionale (French civil aviation safety department – inter-regional)
EASA	European Aviation Safety Agency Agency
ECAM	Electronic Centralized Aircraft Monitoring
EEPROM	Electrically Erasable Programmable Read Only Memory
EFCS	Electronic Flight Control System
ELT	Emergency Locator Transmitter
ENAC	Ecole Nationale de l'Aviation Civile (French national civil aviation school)
EQAR	Extended-storage Quick Access Recorder
ETOPS	Extended-range Twin-engine Operational Performance Standards
FAA	Federal Aviation Administration (USA)
FANS	Future Air Navigation System
FBS	Fixed Base Simulator
FCL	Flight Crew Licensing
FCOM	Flight Crew Operating Manual
FCPC	Flight Control Primary Computer
FCSC	Flight Control Secondary Computer
FCTM	Flight Crew Training Manual
FCTP	Flight Crew Training Program
FCU	Flight Control Unit
FD	Flight Director
FDR	Flight Data Recorder
FFS	Full Flight Simulator

FIR	Flight Information Region
FL	Flight level
FLIRECP	FLight RECorder Panel
FMA	Flight Mode Annunciator
FMCC	French Mission Control Centre
FMECA	Failure Modes, Effects and Criticality Analysis
FMGEC	Flight Management Guidance and Envelope Computer
FMS	Flight Management System
FNPT	Flight and Navigation Procedures Trainer
FOBN	Flight Operations Briefing Note
FOT	Flight Operations Telex
FPA	Flight Path Angle
FPD	Flight Path Director
FPL	Filed Flight Plan
FPV	Flight Path Vector
FSK	Frequency Shift Keying
ft	Feet
FWC	Flight Warning Computer
GNSS	Global Navigation Satellite System
GPS	Global Positioning System
GPWS	Ground Proximity Warning System
HDG	Heading
HF	High Frequency
HMC	Hub Maintenance Centre
IAC (MAK)	Interstate Aviation Committee
IAMSAR	International Aeronautical and Maritime Search and Rescue Manual
IAS	Indicated Airspeed
ICAO	International Civil Aviation Organisation
ICATEE	International Committee for Aviation Training in Extended Envelopes
IFR	Instrument Flight Rules
IFREMER	Institut Français de Recherche pour l'Exploitation de la Mer (French sea research institute)
IMC	Instrument Meteorological Conditions
IMO	International Maritime Organisation
INFRAERO	Empresa Brasileira de Infraestrutura Aeroportuária (Brazilian airport infrastructure organisation)
IR	Inertial Reference
ISIS	Integrated Standby Instrument System
ITCZ	Inter-Tropical Zone Convergence
JAA	Joint Aviation Authorities
JAR	Joint Aviation Requirements
JOEB	Joint Operations Evaluation Board
JRCC	Joint Rescue Coordination Centre

kHz	Kilohertz
kt	Knot
LMC	Last Minute Change
MAC	Mean Aerodynamic Chord
MCC	Multi Crew Cooperation
MD	Mach Dive
MEL	Minimum Equipment List
METAR	Aerodrome routine meteorological report
MFTD	Maintenance and Flight Training Device
MMO	Mach Maximum Operating
MRCC	Maritime Rescue Control Centre
NCD	Non Computed Data
ND	Navigation Display
NM	Nautical Mile
NTSB	National Transportation Safety Board (USA)
OAT	Outside Air temperature
OCC	Operations Control Centre
OEB	Operations Evaluation Board
OSD	Operational Suitability Data
PEPN	Pôle d'Expertise du Personnel Navigant (Flight crew expertise centre)
PF	Pilot Flying
PFD	Primary Flight Display
PFR	Post Flight Report
PHC	Probes Heat Computer
PNF	Pilot Not Flying
Ps	Static pressure
Pt	Total pressure
QRH	Quick Reference Handbook
QTG	Qualification Test Guide
RANP	Regional Aeronautical Navigation Plan
RCC	Regional Control Centre
RCC	Rescue Coordination Centre
RMP	Radio Management Panel
ROV	Remotely Operated Vehicle
RTLU	Rudder Travel Limitation Unit
SAR	Search And Rescue
SAT	Static Air Temperature
SATCOM	Satellite Communication
SB	Service Bulletin
SC	Single Chime
SDU	Satellite Data Unit
SEC	Spoiler Elevator Computer

SELCAL	Selective Calling System
SEP	Single Engine Piston
SGMer	Secrétariat Général à la Mer (general maritime secretariat)
SIGMET	Information concerning en-route weather phenomena which may affect the safety of aircraft operations
SIL	Service Information Letter
SISCECAB	Sistema de Controle do Espaço Aéreo Brasileiro (Brazilian ATC system)
SOP	Standard Operational Procedures
SPD	Speed
SPOC	SAR Point Of Contact
SRPV-SP	Serviço Regional de Proteção ao Voo de São Paulo (Sao Paulo flight protection regional service)
SRR	Search and Rescue Region
SSCVR	Solid State Cockpit Voice Recorder
SSFDR	Solid State Flight Data Recorder
SSM	Sign Status Matrix
STD	Standard Atmosphere
TAF	Aerodrome Forecast
TAS	True Air Speed
TAT	Total Air Temperature
TCAS	Traffic alert and Collision Avoidance System
TEMSI	Significant weather charts
THS	Trimmable Horizontal Stabilizer
TOGA	Take Off / Go Around
TPL	Towed Pinger Locator
TRE	Type Rating Examiner
TRI	Type Rating Instructor
TRK	Track
TRTO	Type Rating Training Organisation
UAS	Unreliable Air Speed
ULB	Underwater Locator Beacon
UTC	Universal Time Coordinated
V/S	Vertical Speed
VD	Velocity Dive
VHF	Very High Frequency
VMO	Maximum Operating Velocity
Vsw	Stall Warning speed

Synopsis

Date of accident

1st June 2009 at 2 h 14 min 28⁽¹⁾

Site of accident

At reference 3°03'57" N, 30°33'42" W, near the TASIL point, in international waters, Atlantic Ocean

Type of flight

International public transport of passengers
Scheduled flight AF 447

Aircraft

Airbus A330-203
Registered F-GZCP

Owner and Operator

Air France

Operator

Air France

Persons on board

Flight crew: 3
Cabin crew: 9
Passengers: 216

⁽¹⁾All times in this report are UTC, except where otherwise specified. Two hours should be added to obtain the legal time applicable in metropolitan France on the day of the event, and three hours subtracted for Rio de Janeiro time.

On 31 May 2009, the Airbus A330 flight AF 447 took off from Rio de Janeiro Galeão airport bound for Paris Charles de Gaulle. The aeroplane was in contact with the Brazilian ATLANTICO control centre on the INTOL – SALPU – ORARO - TASIL route at FL350. At around 2 h 02, the Captain left the cockpit. At around 2 h 08, the crew made a course change of 12 degrees to the left, probably to avoid returns detected by the weather radar.

At 2 h 10 min 05, likely following the obstruction of the Pitot probes by ice crystals, the speed indications were incorrect and some automatic systems disconnected. The aeroplane's flight path was not controlled by the two copilots. They were rejoined 1 minute 30 later by the Captain, while the aeroplane was in a stall situation that lasted until the impact with the sea at 2 h 14 min 28.

The accident resulted from the following succession of events:

- Temporary inconsistency between the measured airspeeds, likely following the obstruction of the Pitot probes by ice crystals that led in particular to autopilot disconnection and a reconfiguration to alternate law,
- Inappropriate control inputs that destabilized the flight path,
- The crew not making the connection between the loss of indicated airspeeds and the appropriate procedure,
- The PNF's late identification of the deviation in the flight path and insufficient correction by the PF,
- The crew not identifying the approach to stall, the lack of an immediate reaction on its part and exit from the flight envelope,
- The crew's failure to diagnose of the stall situation and, consequently, the lack of any actions that would have made recovery possible.

The BEA has addressed 41 Safety Recommendations to the DGAC, EASA, the FAA, ICAO and to the Brazilian and Senegalese authorities related to flight recorders, certification, training and recurrent training of pilots, relief of the Captain, SAR and ATC, flight simulators, cockpit ergonomics, operational feedback and oversight of operators by the national oversight authority.

ORGANISATION OF THE INVESTIGATION

On Monday 1st June 2009 at around 7 h 45, the BEA was alerted by the Air France Operations Coordination Centre, that it had received no news from the Airbus A330-200, registered F-GZCP, undertaking flight AF 447 between Rio de Janeiro Galeão (Brazil) and Paris Charles de Gaulle. After having established without doubt that the aeroplane had disappeared over international waters, and in accordance with Annex 13 to the Convention on International Civil Aviation and to the French Civil Aviation Code (Book VII), the BEA, as Investigation Authority of the State of Registry of the aeroplane, instituted a safety investigation and a team was formed to conduct it.

In accordance with the provisions of Annex 13, Brazilian, American, British, German and Senegalese accredited representatives were associated with the investigation as the State of the engine manufacturer (NTSB) and because they were able to supply essential information to the investigation (CENIPA, ANAC) or because they provided assistance in the sea search phases (AAIB, BFU). The following countries also nominated observers as some of their citizens were among the victims:

- China,
- Hungary,
- Ireland,
- Italy,
- Korea,
- Lebanon,
- Morocco,
- Norway,
- Russia,
- Switzerland.

On the evening of Monday 1st June, a team consisting of two BEA investigators left for Brazil.

The BEA Investigator-in-Charge initially set up four working groups to determine and gather the information required for the investigation in the following areas:

- Sea searches,
- Maintenance,
- Operations,
- Systems and equipment.

These working groups worked from 1st June onwards. Working group plenary sessions were held regularly in order to update investigation information.

After the publication of the two interim reports, on 2 July and 17 December 2009, the investigation focused essentially on the sea search operations:

- Phase 3 took place from 2 to 25 April 2010 and from 3 to 24 May 2010. An area of 6,300 km² was covered, without success.
- Phase 4 took place from 23 March to 12 April 2011. During this campaign, the wreckage of the Airbus A330 undertaking flight AF447 was located on 2 April, about 6.5 nautical miles north-east on the radial 019 from the last known position transmitted by the aeroplane.

- Phase 5, to recover the flight recorders, began on 22 April 2011. The Flight Data Recorder (DFDR) module was found and brought to the surface on 1st May and the Cockpit Voice Recorder (CVR) on 2 May 2011. The two recorders were then shipped to Cayenne from 7 to 11 May by the French Navy patrol boat "La Capricieuse". They were then flown on a scheduled flight to Paris, where they arrived on the morning of 12 May. Phase 5 continued work at the accident site with the recovery of the parts of the aeroplane that were useful to the investigation and the raising of 104 bodies. Phase 5 ended on 16 June 2011 with the arrival of the victims' bodies and the aeroplane parts in the port of Bayonne. The bodies were transferred to the Villejuif mortuary for identification. The aeroplane parts were handed over to the CEAT in Toulouse, with the other parts of the aeroplane, for examination.

At that time, the "Sea Searches" group had completed its work.

The recorder readout work began on 13 May 2011. All of the 1,300 parameters from the DFDR were available by 14 May and readout of the whole 2 hours of the CVR recording was performed on 15 May 2011.

After completion of the first analytical work on the recorders, the BEA published a note describing, in a factual manner, the series of events that led to the accident, and presented some new findings.

On 29 July 2011, a third Interim report was published. It presented all of the information available at that time. It also contained the first points from the analysis and some new findings.

At this stage of the investigation, it was clear that it was necessary to understand the pilots' behaviour more profoundly. It was thus decided to set up a new working group dedicated to Human Factors, the group being made up of pilots from EASA and the DGAC, a specialist in cognitive sciences, a doctor and BEA investigators.

This working group worked in close liaison with the "Operations" and "Systems and Equipment" groups. Its work formed the basis of the new elements in the investigation that were included in the Draft Final Report, which was sent for consultation to the participants in the investigation, in accordance with the provisions of Annex 13 and the European Regulation on investigations and the prevention of aviation accidents and incidents, in force since October 2010.

Integration of the comments received led to the drafting, then the publication, of the Final Report of the Safety Investigation, on 5 July 2012.

1 - FACTUAL INFORMATION

1.1 History of Flight

On Sunday 31 May 2009, the Airbus A330-203 registered F-GZCP operated by Air France was programmed to perform scheduled flight AF 447 between Rio de Janeiro Galeão and Paris Charles de Gaulle. Twelve crew members (3 flight crew, 9 cabin crew) and 216 passengers were on board. The departure was planned for 22 h 00.

At around 22 h 10, the crew was cleared to start up engines and leave the stand. Takeoff took place at 22 h 29. The Captain was Pilot Not Flying (PNF); one of the copilots was Pilot Flying (PF).

At the start of the Cockpit Voice Recorder (CVR) recording, shortly after midnight, the aeroplane was in cruise at flight level 350. Autopilot 2 and auto-thrust were engaged. Auto fuel transfer in the "trim tank" was carried out during the climb. The flight was calm.

At 1 h 35, the aeroplane arrived at INTOL point and the crew left the Recife frequency to change to HF communication with the Atlántico Oceanic control centre. A SELCAL test was successfully carried out, but attempts to establish an ADS-C connection with DAKAR Oceanic failed.

Shortly afterwards, the co-pilot modified the scale on his Navigation Display (ND) from 320 NM to 160 NM and noted "...a thing straight ahead". The Captain confirmed and the crew again discussed the fact that the high temperature meant that they could not climb to flight level 370.

At 1 h 45, the aeroplane entered a slightly turbulent zone, just before SALPU point.

Note: At about 0 h 30 the crew had received information from the OCC about the presence of a convective zone linked to the inter-tropical convergence zone (ITCZ) between SALPU and TASIL.

The crew dimmed the lighting in the cockpit and switched on the lights "to see". The co-pilot noted that they were "entering the cloud layer" and that it would have been good to be able to climb. A few minutes later, the turbulence increased slightly in strength.

Shortly after 1 h 52, the turbulence stopped. The co-pilot again drew the Captain's attention to the REC MAX value, which had then reached flight level (FL) 375. A short time later, the Captain woke the second co-pilot and said "[...] he's going to take my place".

At around 2 h 00, after leaving his seat, the Captain attended the briefing between the two co-pilots, during which the PF (seated on the right) said specifically that "well the little bit of turbulence that you just saw we should find the same ahead we're in the cloud layer unfortunately we can't climb much for the moment because the temperature is falling more slowly than forecast" and that "the logon with DAKAR failed". Then the Captain left the cockpit.

The aeroplane approached the ORARO point. It was flying at flight level 350 and at Mach 0.82. The pitch attitude was about 2.5 degrees. The weight and balance of the aeroplane were around 205 tonnes and 29%.

The two copilots again discussed the temperature and the REC MAX. The turbulence increased slightly. At 2 h 06, the PF called the cabin crew, telling them that *"in two minutes we ought to be in an area where it will start moving about a bit more than now you'll have to watch out there"* and he added *"I'll call you when we're out of it"*.

At around 2 h 08, the PNF proposed *"go to the left a bit [...]"*. The HDG mode was activated and the selected heading decreased by about 12 degrees in relation to the route. The PNF changed the gain adjustment on his weather radar to maximum, after noticing that it was in calibrated mode. The crew decided to reduce the speed to about Mach 0.8 and engine de-icing was turned on.

At 2 h 10 min 05, the autopilot then the auto-thrust disconnected and the PF said *"I have the controls"*. The aeroplane began to roll to the right and the PF made a nose-up and left input. The stall warning triggered briefly twice in a row. The recorded parameters showed a sharp fall from about 275 kt to 60 kt in the speed displayed on the left primary flight display (PFD), then a few moments later in the speed displayed on the integrated standby instrument system (ISIS). The flight control law reconfigured from normal to alternate. The Flight Directors (FD) were not disconnected by the crew, but the crossbars disappeared.

Note: Only the speeds displayed on the left side and on the ISIS are recorded on the FDR; the speed displayed on the right side is not recorded.

At 2 h 10 min 16, the PNF said *"we've lost the speeds "* then *"alternate law protections"*. The PF made rapid and high amplitude roll control inputs, more or less from stop to stop. He also made a nose-up input that increased the aeroplane's pitch attitude up to 11° in ten seconds.

Between 2 h 10 min 18 and 2 h 10 min 25, the PNF read out the ECAM messages in a disorganized manner. He mentioned the loss of autothrust and the reconfiguration to alternate law. The thrust lock function was de-activated. The PNF called out and turned on the wing anti-icing.

The PNF said that the aeroplane was climbing and asked the PF several times to descend. The latter then made several nose-down inputs that resulted in a reduction in the pitch attitude and the vertical speed. The aeroplane was then at about 37,000 ft and continued to climb.

At about 2 h 10 min 36, the speed displayed on the left side became valid again and was then 223 kt; the ISIS speed was still erroneous. The aeroplane had lost about 50 kt since the autopilot disconnection and the beginning of the climb. The speed displayed on the left side was incorrect for 29 seconds.

At 2 h 10 min 47, the thrust controls were pulled back slightly to 2/3 of the IDLE/CLB notch (85% of N1). Two seconds later, the pitch attitude came back to a little above 6°, the roll was controlled and the angle of attack was slightly less than 5°.

The aeroplane's pitch attitude increased progressively beyond 10 degrees and the plane started to climb.

From 2 h 10 min 50, the PNF called the Captain several times.

At 2 h 10 min 51, the stall warning triggered again, in a continuous manner. The thrust levers were positioned in the TO/GA detent and the PF made nose-up inputs. The recorded angle of attack, of around 6 degrees at the triggering of the stall

warning, continued to increase. The trimmable horizontal stabilizer (THS) began a nose-up movement and moved from 3 to 13 degrees pitch-up in about 1 minute and remained in the latter position until the end of the flight. Around fifteen seconds later, the ADR3 being selected on the right side PFD, the speed on the PF side became valid again at the same time as that displayed on the ISIS. It was then at 185kt and the three displayed airspeeds were consistent. The PF continued to make nose-up inputs. The aeroplane's altitude reached its maximum of about 38,000 ft; its pitch attitude and angle of attack were 16 degrees.

At 2 h 11 min 37, the PNF said *"controls to the left"*, took over priority without any callout and continued to handle the aeroplane. The PF almost immediately took back priority without any callout and continued piloting.

At around 2 h 11 min 42, the Captain re-entered the cockpit. During the following seconds, all of the recorded speeds became invalid and the stall warning stopped, after having sounded continuously for 54 seconds. The altitude was then about 35,000 ft, the angle of attack exceeded 40 degrees and the vertical speed was about -10,000 ft/min. The aeroplane's pitch attitude did not exceed 15 degrees and the engines' N1's were close to 100%. The aeroplane was subject to roll oscillations to the right that sometimes reached 40 degrees. The PF made an input on the side-stick to the left stop and nose-up, which lasted about 30 seconds.

At 2 h 12 min 02, the PF said, *"I have no more displays"*, and the PNF *"we have no valid indications"*. At that moment, the thrust levers were in the IDLE detent and the engines' N1's were at 55%. Around fifteen seconds later, the PF made pitch-down inputs. In the following moments, the angle of attack decreased, the speeds became valid again and the stall warning triggered again.

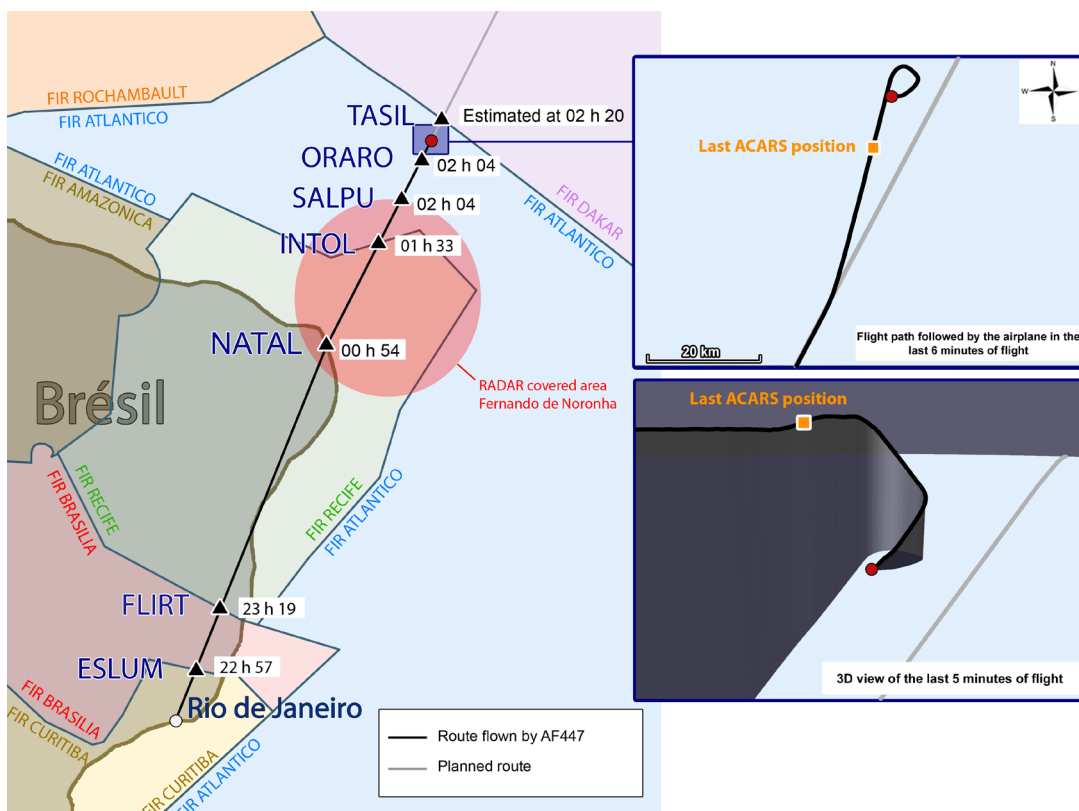

Figure 1: History of Flight

At 2 h 13 min 32, the PF said, “[we’re going to arrive] at level one hundred”. About fifteen seconds later, simultaneous inputs by both pilots on the side-sticks were recorded and the PF said, “go ahead you have the controls”.

The angle of attack, when it was valid, always remained above 35 degrees.

From 2 h 14 min 17, the Ground Proximity Warning System (GPWS) “sink rate” and then “pull up” warnings sounded.

The recordings stopped at 2 h 14 min 28. The last recorded values were a vertical speed of -10,912 ft/min, a ground speed of 107 kt, pitch attitude of 16.2 degrees nose-up, roll angle of 5.3 degrees left and a magnetic heading of 270 degrees.

No emergency message was transmitted by the crew. The wreckage was found at a depth of 3,900 metres on 2 April 2011 at about 6.5 NM on the radial 019 from the last position transmitted by the aeroplane.

1.2 Killed and Injured

Injuries	Crew Members	Passengers	Others
Fatal	12	216	-
Serious	-	-	-
Light/none	-	-	-

1.3 Damage to Aircraft

The aeroplane was destroyed.

1.4 Other Damage

Not applicable.

1.5 Personnel Information

Given the length of the planned flight and in compliance with the Air France operations manual and with the regulations in force, the flight crew was augmented by a copilot.

At the time of the event, the flight crew consisted of two copilots. The copilot in the right seat was the relief for the Captain (see § 1.17.2.3).

Note: The crew had left Paris on Thursday 28 May 2009 in the morning and arrived in Rio de Janeiro in the evening of the same day.

1.5.1 Flight crew

1.5.1.1 Captain

Male, aged 58

Medical certificate (class 1) issued on 10 October 2008, valid until 31 October 2009

Experience:

- total: 10,988 flying hours, of which 6,258 as Captain
- hours on type: 1,747 all as Captain
- in the previous six months: 346 hours, 18 landings, 15 take-offs
- in the previous three months: 168 hours, 8 landings, 6 take-offs
- in the previous 30 days: 57 hours, 3 landings, 2 take-offs

The Captain had carried out sixteen rotations in the South America sector since he arrived in the A330/A340 division in 2007. His Oceanic route qualification was valid until 31 May 2010.

1.5.1.1.1 Aviation career details

- Private Pilot's License issued in 1974
- Flight attendant from February 1976 to June 1982 (Air France)
- Commercial Pilot's License issued in 1977. Practical test taken on a Cessna 177 after training at the training centre of the Technical Control and Training Service of the French civil aviation directorate (Direction Générale de l'Aviation Civile) in Grenoble. Instrument rating (IFR) issued in 1978 (on a PA30).
- Private flight instructor qualification obtained in 1979
- 1st class professional pilot theory in 1979
- Airline transport pilot theory in 1980
- Mountain rating (altiport category) issued in 1981
- 1st class professional Pilot's License issued in 1982. Tests taken on a Nord 262 after training at the Technical Control and Training Service centre of the French civil aviation directorate (Direction Générale de l'Aviation Civile) in Saint-Yan
- Demonstration pilot from January to March 1983 (Inter Avia Service Company)
- Pilot from June 1983 to August 1984 for various companies
- Several other type ratings obtained between 1977 and 1987:
 - C177 (1977), C310 (1977), C401 / C402 (1982), C421 (1983)
 - PA23 (1978), PA30 (1979), PA34 (1980), PA31 (1984)
 - BE65 (1981), BE 55/58 (1982), BE60 (1983), BE20 (1987), BE90 and BE10 (1987)
 - BN2A (1981)
 - N262 (1982)
 - MU2 (1983)
- Independent pilot from October 1984 to February 1988
- Joins Air Inter airline in February 1988 as copilot
- Caravelle XII type rating in 1988
- A300 type rating in 1990 (within Air Inter)
- Airline pilot training course from 12 August 1991 to 15 January 1992 (within Air Inter)
- ATPL License without limitations issued 19 February 1992
- 1st class professional pilot instructor (IPP1) rating issued in 1993
- A320 type rating issued on 13 March 1997 (within Air Inter). Line training completed and pilot in command for first time on 3 April 1997

Note: The merger between Air France and Air Inter took place on 1 April 1997

- ❑ Boeing 737-200 type rating (within Air France), end of line training and appointed Captain on 19 June 1998
- ❑ New A320 type rating issued 29 May 2001 (within Air France)
- ❑ Additional A330 type rating issued 27 October 2006 (within Air France). Unfit after line training test flight 17 January 2007, extended A330 line training and satisfactory test on 17 February 2007
- ❑ Additional A340 type rating issued 9 August 2007 (within Air France). Line training completed and pilot in command for first time on 7 September 2007
- ❑ Last medical certificate (class 1) issued on 10 October 2008, valid until 31 October 2009
- ❑ 2008/2009 and 2009/2010 ECP instruction seasons:
 - A330 (CEL33) line check on 15 February 2007
 - A340 (CEL34) line check on 7 September 2007
 - A330 (E33) training on 12 March 2008
 - A340 (CEL34) line check on 21 July 2008
 - 4S ground training on 7 August 2008
 - A340 (E34) training on 11 October 2008
 - A330 (C33) base check on 12 October 2008
 - S1 ground training on 12 January 2009
 - A330 (E33) training on 22 April 2009
 - A340 (C34) base check on 23 April 2009

1.5.1.1.2 Training courses and specific training

➤ **Unreliable IAS**

- ❑ FFS session n°1 (Air Inter A320 type rating) on 24 February 1997 “vol avec IAS douteuse”. This session also included a “Study of high altitude flight (35,000 ft)” exercise
- ❑ 2008-2009 instruction season E33 training on simulator. “IAS douteuse” exercise

Note: The A320 type rating programme at Air France in 2001 did not include a “vol avec IAS douteuse” exercise.

➤ **Stall**

- ❑ A300 type rating (Air Inter): FFS session n°3 “level flight (FL 330) - stall”
- ❑ A320 type rating (Air Inter): FFS session n°1 “study of stall and recovery of the trajectory
- ❑ A320 type rating (Air France): FFS session n°7, exercise on “low speed demonstration in direct law and recuperation after a STALL alarm”. The stall procedure in force was that from December 1999

➤ **Unusual attitudes**

- ❑ Additional A330 type rating: computer assisted self-learning module “Unusual attitudes – Use of the rudder” completed on 28 September 2006

➤ **Piloting in alternate law**

- ❑ A320 type rating (Air France): FFS session n°4 “flying in alternate law and direct law”

1.5.1.2 Co-pilot in left seat

Male, aged 37

- Medical certificate (class 1) issued 11 December 2008, valid until 31 December 2009 with compulsory wearing of corrective lenses.
- Experience:
 - total: 6,547 flying hours
 - on type: 4,479 flying hours
 - in the previous six months: 204 hours, 9 landings, 11 take-offs
 - in the previous three months: 99 hours, 6 landings, 5 take-offs
 - in the previous thirty days: 39 hours, 2 landings, 2 take-offs
- May 2009 activity at the OCC:
 - 12 May from 6 h to 16 h
 - 13 May 16 h to 14 May 6 h
 - 17 May from 6 h to 16 h
 - 18 May 16 h to 19 May 6 h
 - from 20 May 8 h to 22 May 17 h

Before the outward flight, his last landing on an A330 dated from 9 March 2009. He had flown the outward Paris-Rio flight as PF to gain the recent experience required to keep his dual A330/A340 rating up-to-date.

This pilot had performed 39 rotations on the South America sector since arriving in the A330/A340 division in 2002. His Oceanic route qualification was valid until 28 February 2010.

1.5.1.2.1 Aviation career details

- Basic license issued in 1992
- Airline pilot theory in 1992
- Professional Pilot's License in 1993 (EPT ENAC)
- Multi-engine instrument rating issued in 1993

Note: In the context of economic crisis in air transport, in autumn 1992 Air France stopped pilot training courses and drew up a waiting list in 1993.

- Training as Air Traffic Control Engineer at ENAC until 1998. In August 1997, request to delay joining Air France in order to finish this training
- Fit for starting type rating training at Air France in July 1998
- Training in Multi Crew Co-ordination (MCC) in August 1998 by the Air France TRTO
- A320 type rating issued in November 1998 (within Air France). End of LOFT and pilot in command for first time 14 February 1999
- Air transport airline pilot's license issued in April 2001
- Additional A340 type rating in February 2002 (within Air France). End of line training and pilot in command for first time in April 2002
- Additional A330 type rating and line training in October 2002
- Assigned to Air Calédonie Internationale airline for two months in 2005 to carry out flights on A330 on the Tokyo – Nouméa route
- Renewal of SEP rating on TB10 in Nouméa in 2005

- He was appointed (as) cadre at the Technical Flight Crew Division as representative of the Flight Deck Crew hub at the CCO from 1st May 2008
- 2008/2009 and 2009/2010 ECP instruction seasons:
 - CEL34 line check 30 October 2007
 - E34 training 22 July 2008
 - C33 base check 23 July 2008
 - CEL33 line check 26 October 2008
 - E33 training 6 December 2008
 - 4S ground training 10 December 2008
 - C34 base flight check 21 December 2008
 - S1 ground training 18 March 2009

1.5.1.2.2 Training courses and specific training

➤ **Unreliable IAS**

- 2008-2009 instruction season E33 simulator training. "IAS douteuse" exercise

Note: The A320 type rating programme at Air France in 1998 did not include a "vol avec IAS douteuse" exercise.

➤ **Stall**

- A320 type rating: FFS session n°4: "piloting in degraded law (effect of buffeting) in alternate law"

1.5.1.3 Copilot in right seat

Male, aged 32

- Medical certificate (class 1) issued on 24 October 2008, valid until 31 October 2009 with compulsory wearing of corrective lenses.
- Experience:
 - total: 2,936 flying hours
 - on type: 807 flying hours
 - in the previous six months: 368 hours, 16 landings, 18 take-offs
 - in the previous three months: 191 hours, 7 landings, 8 take-offs
 - in the previous thirty days: 61 hours, 1 landing, 2 take-offs

This pilot had performed five rotations in the South America sector since arriving in the A330/A340 division in 2008, including one to Rio de Janeiro. His Oceanic route qualification was valid until 31 May 2010.

1.5.1.3.1 Aviation career details

- Private Pilot's License issued in 2000
- ATPL theory in 2000
- Professional pilot's license issued in 2001
- Multi-engine instrument type rating issued in 2001
- Glider pilot's license issued in 2001
- Following his selection by Air France, pilot training course at the Amaury de la Grange flying school in Merville from October 2003

- ❑ A320 type rating issued in 2004 (within Air France). End of line training and pilot in command for first time in September 2004
- ❑ ATPL License issued on 3 August 2007
- ❑ Additional A340 type rating issued in February 2008 (with Air France). End of LOFT and pilot in command for first time in June 2008
- ❑ Additional A330 type rating and line training in December 2008
- ❑ 2008/2009 ECP instruction season:
 - 4S ground training on 15 January 2009
 - E33 training on 2 February 2009
 - C34 base flight check on 3 February 2009

Note: The validity of the E34, C33, CEL34, CEL33, S1 training courses, checks and ground training is covered by the dates of issue of the Airbus A330 and A340 type rating as well as by the end of line training date.

1.5.1.3.2 Training courses and specific training

➤ **Unreliable IAS**

- ❑ 2008-2009 instruction season E33 simulator training. "IAS douteuse" exercise

Note: The A320 type rating programme at Air France in 2004 did not include a "vol avec IAS douteuse" exercise.

➤ **Stall**

- ❑ A320 type rating: FFS session n°4: "piloting in degraded law (effect of buffeting) in alternate law"
- ❑ A320 type rating: FFS session n°7: "Preventive recognition and countermeasures to approach to stall. DEMONSTRATION STALL WARNING". The STALL procedure in force was that from December 1999

General note: The additional A330 and A340 type ratings deal only with the differences in relation to the type ratings already issued on other types (A320, A330, and A340).

1.5.2 Cabin crew

For this aeroplane, the regulatory minimum cabin crew composition as provided for in the Operations Manual is five people.

On flight AF 447, nine members of the crew were on duty in the passenger cabin:

- ❑ One senior flight attendant, qualified on the A330/A340;
- ❑ Two pursers, qualified on the A330/A340;
- ❑ Three cabin crew members, qualified on the A330/A340 (cabin crew required by regulations);
- ❑ Two additional cabin crew members, not fully qualified on the A330/A340 (additional cabin crew to the minimum required by regulations);
- ❑ A back-up cabin crew member.

1.6 Aircraft Information

Air France had owned the aircraft since April 2005. It had been delivered new.

1.6.1 Airframe

Manufacturer	Airbus
Type	A330-203
Serial number	0660
Registration	F-GZCP
Entry into service	April 2005
Certificate of Airworthiness	N°122424/1 dated 18 April 2005 issued by the DGAC
Airworthiness examination certificate	2009/122424/1 valid until 17/4/2010
Utilisation as of 31 May 2009	18,870 flying hours and 2,644 cycles

1.6.2 Engines

- Manufacturer: General Electric
- Type: CF6-80-E1A3

	Engine N°1	Engine N°2
Serial number	811296	811297
Installation date	1/10/2004	1/10/2004
Total running time	18,870 hours and 2,644 cycles	18,870 hours and 2,644 cycles

The engines were subject to real-time monitoring in the framework of the engine condition monitoring program. Examination of the data recorded, including the data transmitted on the day of the accident, shows that both engines were functioning normally.

1.6.3 Weight and balance

The aeroplane left the stand with a calculated weight of 233,257 kg. The estimated takeoff weight was 232,757 kg for a maximum authorised takeoff weight of 233 t. This takeoff weight was broken down as follows:

- An empty operating weight of 126,010 kg
- Passenger weight of 17,615 kg (126 men, 82 women, 7 children and 1 baby)
- Hold weight (cargo and baggage) of 18,732 kg
- Fuel weight of 70,400 kg

The fuel weight on board corresponded to a planned trip-fuel of 63,900 kg, a contingency reserve of 1,460 kg, a final reserve of 2,200 kg, an alternate fuel reserve of 1,900 kg and 940 kg of additional fuel. A LMC (last minute change) corrected the final weight to take into account the absence of one passenger.

The balance corresponding to the aeroplane's takeoff weight and shown on the final load sheet (after LMC) was 23.3% of the MAC (mean aerodynamic chord), which was within the limits.

The recorded data indicates that at the time of the event, the aeroplane's weight was 205.5 tonnes and the balance was 28.7%, which was within the limits.

1.6.4 Condition of the aircraft before departure

On arrival of the aeroplane at Rio de Janeiro the day before the accident, the Captain reported a problem with the VHF1 selection key on a radio management panel (RMP1). The aeroplane was equipped with three RMPs: RMP1 on the left-hand side, RMP2 on the right-hand side and RMP3 on the overhead panel. The ground engineer had switched round RMP1 and RMP3 to allow the aircraft to leave, in compliance with the regulations (departure covered by a MEL). This MEL item did not have any operational consequences.

1.6.5 Maintenance operations follow-up

Daily and weekly checks are carried out. They make it possible to perform preventive maintenance tasks and correct any problems reported after flights by the crew.

Type A checks, on the Airbus A330, are carried out every 800 flying hours, which represents a check every two months approximately for an airline such as Air France. This check consists of:

- Checking the systems by means of operational tests;
- Performing greasing and lubrication operations;
- Carrying out various checks on the oil and hydraulic fluid levels;
- Visually inspecting the structural parts, without removal.

The last three checks of this type were performed on F-GZCP on 27 December 2008, 21 February 2009 and 16 April 2009.

These checks were performed in accordance with the operator's maintenance programme, drawn up on the basis of the manufacturer's recommendations and approved by the national authorities who are also responsible for oversight.

Examination of these maintenance documents, of the maintenance programme and of the aircraft's airworthiness dossier did not reveal any anomalies.

1.6.6 Information on the airspeed measuring system

1.6.6.1 Elaboration of the speed information

The speed is deduced from the measurement of two pressures:

- Total pressure (Pt), by means of an instrument called a Pitot probe;
- Static pressure (Ps), by means of a static pressure sensor.

The Airbus A330 has three Pitot probes (see below) and six static pressure sensors. These probes are fitted with drains allowing the removal of water, and with an electrical heating system designed to prevent them from icing up.

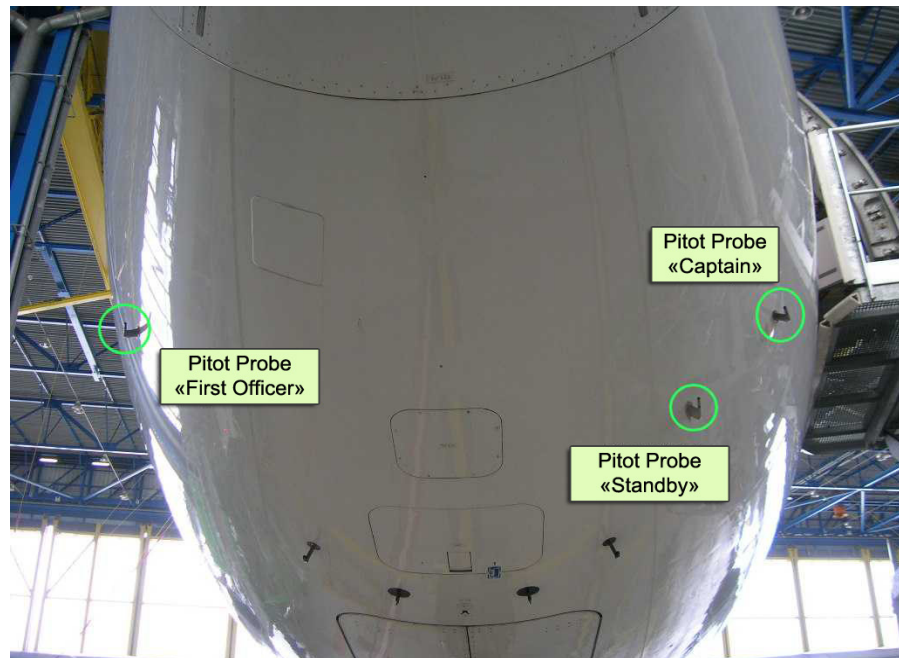

Figure 2: Position of the Pitot probes on the Airbus A330



Figure 3: Pitot probe (with protection caps)

The pneumatic measurements are converted into electrical signals by eight ADM's and delivered to the calculators in that form.

Speed calculation by the ADR

The CAS and Mach number are the main items of speed information used by the pilots and the systems to control the aeroplane. These parameters are elaborated by three computers, called ADIRU, each consisting of:

- ❑ An ADR module which calculates the aerodynamic parameters, specifically the CAS and the Mach;
- ❑ An IR module that provides the parameters delivered by the inertial units, such as ground speed and attitudes.

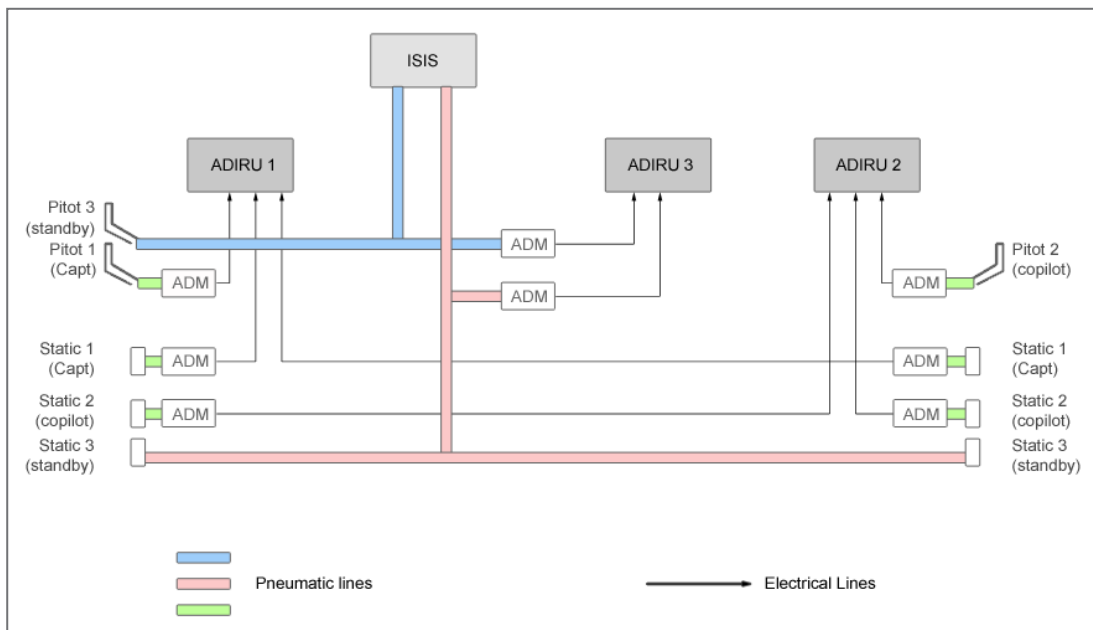

Figure 4: Diagram of the speed measurement system architecture

There are therefore three speed information elaboration systems that function independently of each other. The probes known as “Captain” supply ADR 1, the “First Officer” probes supply ADR 2 and the “Standby” probes supply ADR 3.

The standby instruments elaborate their speed and altitude information directly from the pneumatic inputs (“standby” probes), without this being processed by an ADM or ADR. The ISIS is a unique standby instrument integrating speed, altitude and attitude information. It uses the same static and total pressure sensors as ADR3.

1.6.6.2 Systems using the speed information

The speeds calculated by the ADR’s are used, in particular, by the following systems:

- Fly-by-wire controls system;
- Engine management system;
- Flight management and guidance system;
- Ground proximity warning system;
- Transponder;
- Slat and flap control system.

1.6.7 Checks and maintenance of the Pitot probes

The Pitot probe checks and maintenance actions are described in the operator’s maintenance manual.

The Pitot probes are subject to a daily visual inspection by a mechanic, who checks their general condition. The crew performs the same type of check before each flight.

The following operations are performed on the Pitot probes every 8,000 hours (around every 21 months during a C check):

- Cleaning of the complete probe using compressed air (“blowing” operation);
- Cleaning of the drains with a specific tool;

- Test and check of probe heating by the standby electrical power supply system;
- Check of the sealing of the circuits.

In the case of speed inconsistencies being reported by the crew, corrective actions are the same as those in the Type C checks.

1.6.8 Radio communications system

The Airbus A330's radio communications system consists of the following equipment:

- VHF and HF transmitters-receivers,
- RMP's,
- Audio integration systems: ACP and AMU.

Each VHF / HF transmitter-receiver can be controlled by one of the three RMP's.

1.6.8.1 VHF equipment

There are three identical VHF communication systems installed. Each system includes:

- A transmitter-receiver in the avionics bay;
- An antenna on the upper part of the fuselage for VHF 1 and VHF 3, and on the lower part of the fuselage for VHF 2.

1.6.8.2 HF equipment

The aircraft has two HF communication systems. Each system includes:

- A transmitter-receiver in the avionics bay;
- An antenna coupler situated at the root of the stabiliser;
- A shared antenna integrated in the leading edge of the fin.

Since the HF system has a range of several thousand kilometres, a large number of communications are received. Furthermore, the quality of the transmissions may sometimes be poor. Communications may also be interrupted due to natural phenomena.

A SELCAL call system, transmitting a visual and aural signal, informs the crew when a ground station is attempting to contact them.

1.6.8.3 ADS-C

All the aircraft in the Airbus A330/A340 family are equipped with the avionics necessary for FANS-A operations. Data link communications between the crew and ATC services are exchanged via VHF data, SATCOM, ADS-C and CPDLC.

The on-board Air Traffic Information Management System (ATIMS) incorporates an Air Traffic Services Unit (ATSU) computer that also manages the ACARS maintenance messages. The fact that maintenance messages continued to be delivered until the time of the accident demonstrates that there was no malfunction of the ADS-C or CPDLC.

The ATSU computer, via the FMS, manages all the CPDLC and ADS-C messages. The ACARS system is integrated into the ATSU.

1.6.9 Systems function

1.6.9.1 Probe heating

The probes that are installed on the aircraft are heated electrically to remove water by vaporisation when the aeroplane is on the ground and to protect them from icing in flight. Three independent Probe Heat Computers (PHC) control and monitor the heating of the Pitot and total air temperature (TAT) probes and of the static pressure and angle of attack (AOA) sensors. One of the PHC's manages the Captain probes, another the First Officer probes and the third the standby probes (there is no TAT standby sensor).

There are two function modes, ground and flight. On the ground, neither of the TAT sensors is heated and the three Pitot probes are heated only at low power, to prevent any potential damage. The PROBE / WINDOW HEAT push-button located on the overhead panel in the cockpit allows the crew to force the Pitot tube heating onto flight mode. During the flight, the probes are continuously heated.

The investigation did not reveal any malfunction of the PHC's.

1.6.9.2 Autopilot, flight director and autothrust

The autopilot, flight director and autothrust functions are ensured by two Flight Management Guidance and Envelope Computers (FMGEC), connected in particular to a Flight Control Unit (FCU). Each of these two computers can perform these three functions.

The flight director (FD) displays the control orders from the FMGEC on the PFD. In normal operation, with the FD's engaged (FD push-buttons lit on the FCU), FD 1 displays the orders from FMGEC 1 on PFD 1 (left side) and FD 2 displays the orders from FMGEC 2 on PFD 2 (right side). It is possible to display only one of them at a time, although the Airbus standard operating procedures recommend that either both or neither of them should be displayed. Furthermore, the autopilot 1 function is ensured by FMGEC 1 and the autopilot 2 function by FMGEC 2. The autothrust function (A/THR) is ensured by the FMGEC associated to the engaged autopilot.

The materialisation of the FD on the PFD depends on the mode selected with the HDG-V/S / TRK-FPA push-button:

- In HDG-V/S mode, the FD is represented by two crossbars and represents the autopilot orders;
- In TRK-FPA mode, the FPV speed vector (or "bird") is displayed, it indicates the drift and slope. The associated flight director makes it possible to indicate how to maintain the desired path.

The FD orders, both in HDG-V/S and in TRK-FPA modes, are elaborated by the FMGEC's.

In HDG/VS mode, the flight directors provide the pilots with aircraft handling assistance via the display of crossbars. The vertical (roll) bar shows the trend to follow in lateral control and the horizontal (pitch) bar the trend to follow in longitudinal control. When the bars form a centred cross, the aeroplane is following the calculated flight path.

The manner in which these “cues” are determined varies depending on the mode selected, such that in certain modes the cues determined by the two FMGEC are necessarily identical, whereas in other modes they may differ. The FD’s are switched on by pressing the corresponding pushbuttons on the FCU. When a FD is engaged, the corresponding button lights up.

In order to operate, and determine the FD’s cues, the FMGEC need to use the data from at least two ADR’s and two IR’s, which they must consider to be valid. The monitoring performed by the FMGEC on the ADR and IR parameters looks for deviations with respect to two other values. For example, if one of the parameters from an ADR deviates excessively from the values indicated for the same parameter by the two other ADR’s, then the first shall be considered as invalid and will not be used. If at least two ADR’s or two IR’s are invalid, the FMGEC can no longer determine the FD’s cues and the crossbars disappear. However, the FD’s are not disengaged; the corresponding lights on the FCU remain lit.

Note: In the following, valid FMGEC is referred to when the AP/ATHR/FD functions are available.

If only one of the FMGEC’s is no longer valid, both FD’s display the orders from the other. If the associated autopilot is engaged, it will disconnect automatically, generating the AUTO FLT AP OFF red ECAM message associated with the characteristic “cavalry charge” aural warning and with the MASTER WARNING. Control of autothrust is automatically transferred to the remaining FMGEC.

If both FMGEC’s are invalid, the two FD’s disappear and the red FD flag is displayed on the PFD’s. If one autopilot is engaged, whichever one it may be, it will disconnect automatically, generating the red ECAM message AUTO FLT AP OFF. If the autothrust is engaged, it will disconnect automatically, generating the amber ECAM message AUTO FLT A/THR OFF and activation of the THRUST LOCK function. As long as this function is active:

- The thrust remains locked at the value it had at the time it was activated;
- An amber “THR LK” message flashes on the FMA at the level of the third line in the left column;
- The amber “ENG THRUST LOCKED” ECAM message is displayed and a single chime sounds every five seconds:

Alarme ECAM	Alerte sonore	Alerte visuelle	Page SD	Alarme locale	Inhibé en phase 06
ENG THRUST LOCKED	Single chime Toutes les 5 sec	Master caution Toutes les 5 sec	-	-	non

Thrust must be controlled manually, either by moving the thrust control levers or by pressing the disconnect push-button located on the levers (instinctive disconnect).

Disconnection of the autopilot resets monitoring of the parameters carried out in the FMGEC: as soon as the FMGEC becomes valid again, for example when two speeds are once again consistent with each other, its functions are ensured again. Thus, if the associated FD is still engaged, the red FD flag disappears and the crossbars re-appear automatically. If the associated autopilot and the autothrust are also made available again, a crew action on the corresponding button on the FCU is necessary to re-engage them.

If there is no disconnection action on the FD push buttons of the FCU, the crossbars reappear automatically as soon as the operating conditions are re-established (i.e. when at least two ADR's and two IR's are once again valid) and confirmed for about one second.

In this case, the active modes are HDG and V/S.

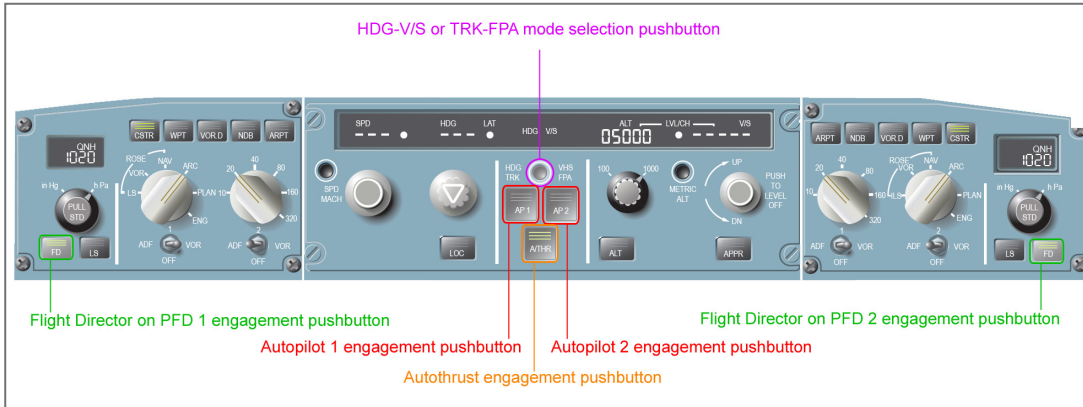

Figure 5: FCU display

Operational use of the flight director

In general, the majority of the flight is undertaken with “FD ON”, with or without the AP, according to the phase of flight. Thus the operator’s manual and the manufacturer’s procedures indicate that the FD’s must be set to “ON” from cockpit preparation onwards. If the pilot chooses not to follow the FD’s orders, the crew is asked to disconnect them.

It is also stated that:

- ❑ “The FMA check is essential to ensure correct operation of the automated systems, but monitoring of the primary parameters such as speed, altitude, VSI, heading, N1, localizer, glide etc is the only guarantee for the aeroplane’s flight path”;
- ❑ “Any deviation must result in rapid action by the pilots, if necessary even before having analyzed the reasons for a malfunction of an automated system”;
- ❑ “An automatic system is, and must remain, an aid”;
- ❑ “When the FD’s are used, given the degree to which the A/THR modes depend on the vertical modes, the FD orders must be followed”;
- ❑ “When the operation of the automatic systems does not correspond to the pilots’ expectations and if the cause is not immediately analyzed without any ambiguity, the system(s) in question must be disconnected”.

1.6.9.3 Control laws

The Airbus A330 has fly-by-wire flight controls. The aeroplane is controlled by means of two side-sticks whose movements are transmitted in the form of electrical signals to flight control computers. This aeroplane has three flight control primary computers, called FCPC or PRIM, and two flight control secondary computers, called FCSC or SEC. Their role is to calculate the position of the various control surfaces as a function of the pilot’s orders.

The laws governing this transformation are called control laws. On the A330 in nominal operation, the control law is called the normal law. In the case where monitoring is triggered in the flight control system, it may be replaced by reconfiguration laws, known as the alternate (alternate 1 or 2) law or direct law.

Normal law offers complete protection of the flight envelope: in terms of attitude (the pitch and bank angles values are limited), load factor, at high speed and at a high angle of attack. When the protections are not triggered, the longitudinal orders from the sidesticks command a load factor according to the aircraft's normal axis and the lateral orders command a rate of roll.

In alternate law, the longitudinal orders from the side-sticks command a load factor according to the aircraft's normal axis, like with normal law but with fewer protections. Furthermore:

- ❑ In alternate 1, the lateral orders from the sidesticks still command a rate of roll;
- ❑ In alternate 2, they command the ailerons and lift dumpers directly.

In direct law, the protections are lost and orders from the sidesticks control the position of the various control surfaces directly.

Another law, called the abnormal attitudes law, is triggered in certain cases where the aircraft's attitude is outside certain ranges, for example when the bank angle exceeds 125 degrees. This is an alternate 2 law with maximum lateral authority and without automatic trimming (see also 1.16.3.3).

Like the FMGEC's, the PRIM's validate the parameters that they use by means of monitoring mechanisms. Concerning the airspeed, it is the voted value that is used. In normal operation, this is the median value. When one of the three speeds deviates too much from the other two, it is automatically rejected by the PRIM's and the voted value then becomes the average of the two remaining values. But if the difference between these two remaining values becomes too great the PRIM's reject them and the control law reconfigures to alternate 2. Furthermore, another monitoring procedure is applied to the value of the voted airspeed and triggers reconfiguring to alternate 2 law when it falls by more than 30 kt in one second.

In alternate or direct law, the angle-of-attack protections are no longer available but a stall warning is triggered when the greatest of the valid angle-of-attack values exceeds a certain threshold (see also 1.6.11).

1.6.9.4 Design and limit speeds

A certain number of speeds are represented by specific symbols on the PFD's speed tape (protection or design speeds – "green dot", F, S, Vmax, Valpha prot, etc).

Some of these speeds are calculated by the FMGEC, others by the PRIM's, which transmit them to the FMGEC for display. In the case where the three ADR's are rejected by the PRIM's, the SPD LIM flag appears at the bottom right of the speed tape and the protections are lost. The current speed and the target speed remain on display. If at least one ADR is valid in the FMGEC's, the Vmax speed may remain displayed on one side and/or the other. In the case where two speeds are consistent within each other, the speed trend arrow is also displayed.

1.6.9.5 Presentation of information on the PFD

A PFD in normal law and a PFD in alternate 2 are shown hereafter. The displays presented on these PFD's are not exact representations of those that could have been displayed on AF 447 crew's PFD's.

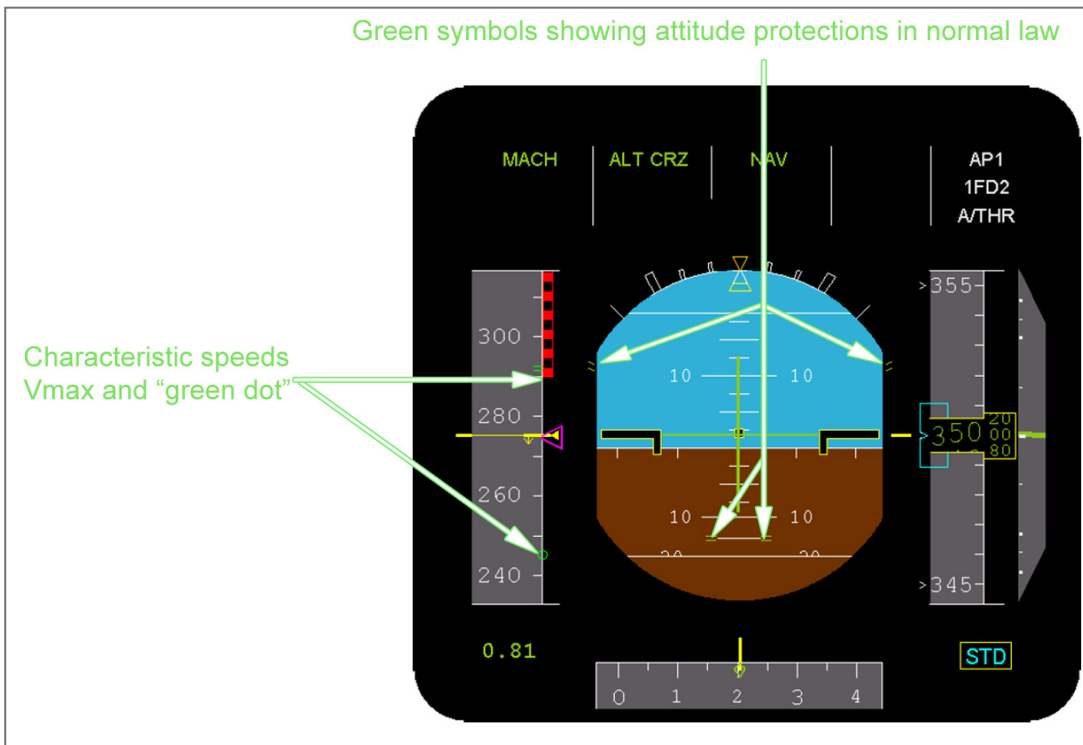

Figure 6: PFD in normal law

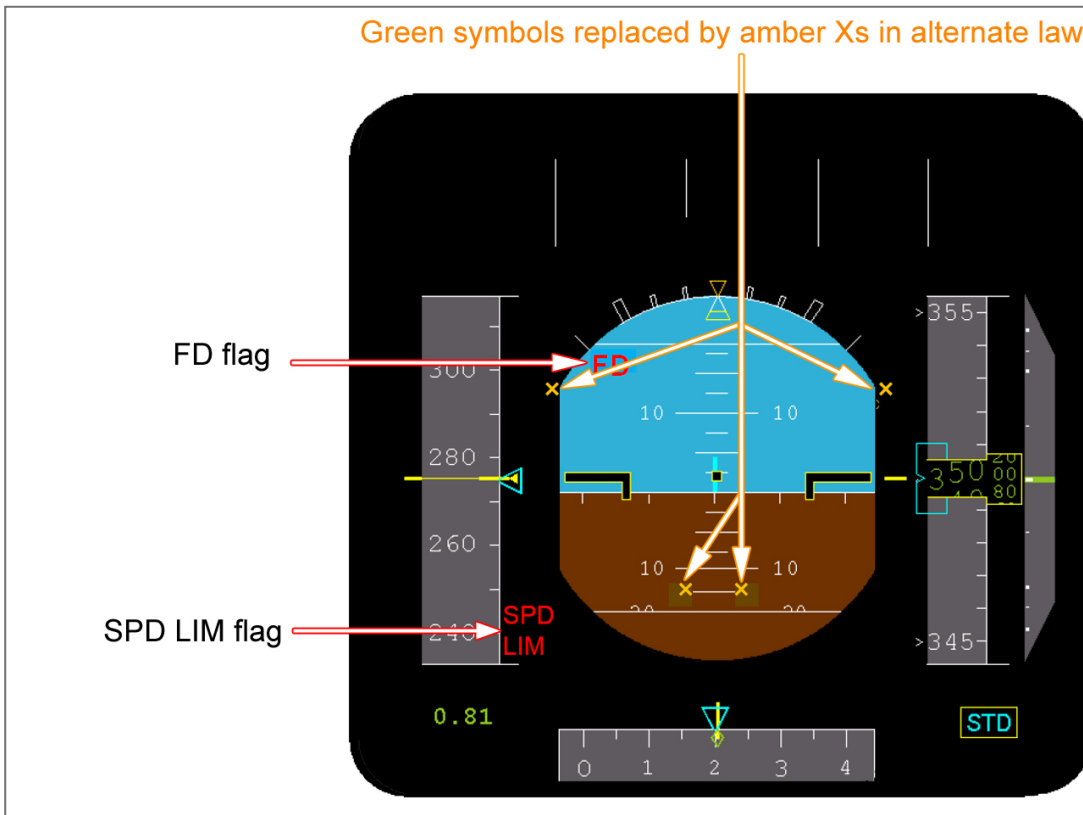

Figure 7: PFD in alternate 2 law

1.6.9.6 Consequences of a blocked Pitot probe on the flight parameters

1.6.9.6.1 Description of the obstruction of a Pitot probe by ice crystals

When highly specific climatic conditions are met, in particular with the presence of ice crystals in excessive quantities, the conditions for use of the probes can exceed the conditions for qualification and robustness. In this type of situation, a partial obstruction of the total pressure probes in icing conditions and at high altitude (above 30,000 feet) can occur. This results in a temporary and reversible deterioration of total pressure measurement.

In the presence of ice crystals, there is no visible accretion of ice or frost on the outside, nor on the nose of the probe, since the crystals bounce off of these surfaces. However, the ice crystals can be ingested by the probe air intake. According to the flight conditions (altitude, temperature, Mach) if the concentration of crystals is greater than the capacity for de-icing of the heating element and evacuation by the purge holes, the crystals accumulate in large numbers in the probe tube.

As a result, a physical barrier is created inside the probe that will disturb the measurement of total pressure, this then being able to approach that of the measured static pressure.

As soon as the concentration of ice crystals is lower than the de-icing capacity of the probe, the physical barrier created by the accumulation of crystals disappears and measurement of the total pressure becomes correct again.

Experience and follow-up of these phenomena in very severe conditions show that this loss of function is of limited duration, in general around 1 or 2 minutes.

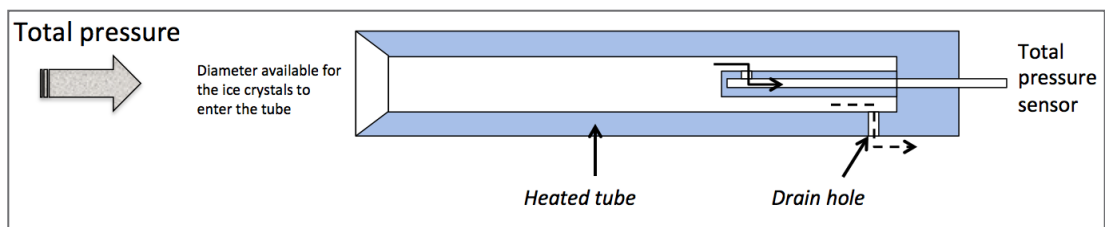

Figure 8: Pitot probe diagram

1.6.9.6.2 Principle of elaboration of flight parameters affected by a drop in total pressure

The static pressure (P_s), total pressure (P_t) and total air temperature (TAT) allow the ADR to calculate the following parameters in particular:

- Mach;
- Calibrated Air Speed (CAS);
- Standard altitude;
- True Air Speed (TAS).

On an A330-200 in cruise flight, as a result of the position of the static pressure sensors, the measured static pressure overestimates the real static pressure. The value of the measured static pressure must thus be corrected of this error before being used to calculate other parameters. The value of the correction depends in particular on the Mach and takes into account the position of the sensors on the fuselage. Thus the correction performed by ADR 3 is different from that performed by ADR 1 and 2.

Note: On A340-300 and A330-300, the correction of the of static pressure measurement is negligible in cruise.

For each airspeed system, the calculation principle is as follows:

- ❑ Knowing P_t and P_s makes it possible to calculate a Mach value that provides access to the correction of P_s ; the P_s thus corrected is then used to calculate the CAS and the standard altitude;
- ❑ With the known Mach value, the TAT measurement makes it possible to determine the static air temperature (SAT), which in turn makes it possible to calculate the true air speed (TAS);
- ❑ The corresponding IR then uses the true air speed to calculate the wind speed from the ground speed. It also uses the derivative of the standard altitude value that it combines with the integration of the measured accelerations to calculate the vertical speed, known as baro-inertial, V_{zbi} , which is that displayed on the PFD in a nominal situation.

The following diagram illustrates these explanations:

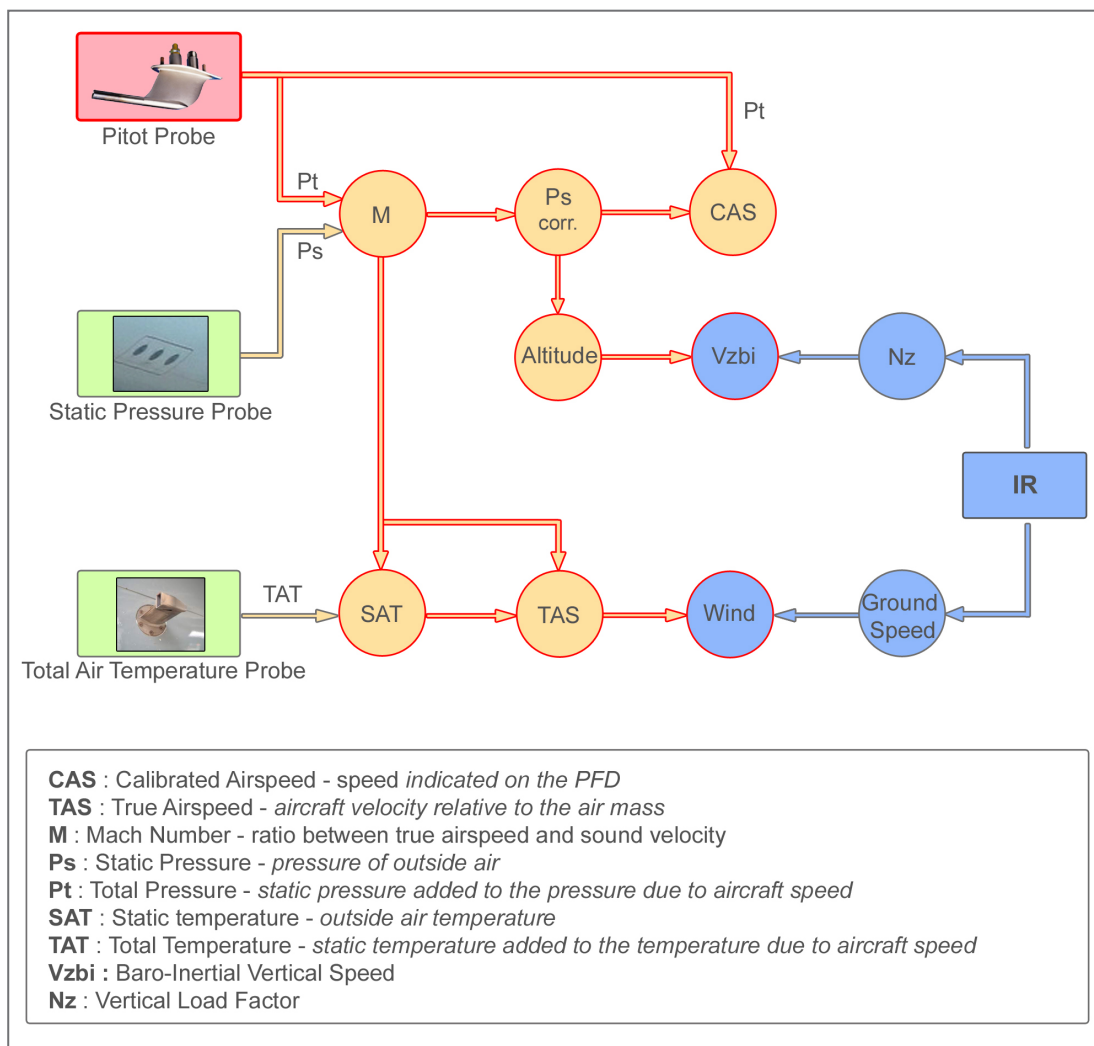

Figure 9: Overview

1.6.9.6.3 Consequences of a drop in the measured total pressure

The first consequence of a drop in measured total pressure is a drop in the Mach and the CAS. The drop in Mach leads to a drop in standard altitude due to the correction of the measured static pressure. This drop is different according to the ADR under consideration: in the flight conditions of the event, it is of the order of 300 to 350 ft for the ADR 1 and 2 and of 80 ft for ADR 3.

The drop in indicated standard altitude also causes a transient variation in Vzbi. Just as the drop in standard altitude is lower for ADR 3 than for ADR 1 and 2, the variation in Vzbi is lower for ADR 3 than for the two others, as illustrated by the graph below:

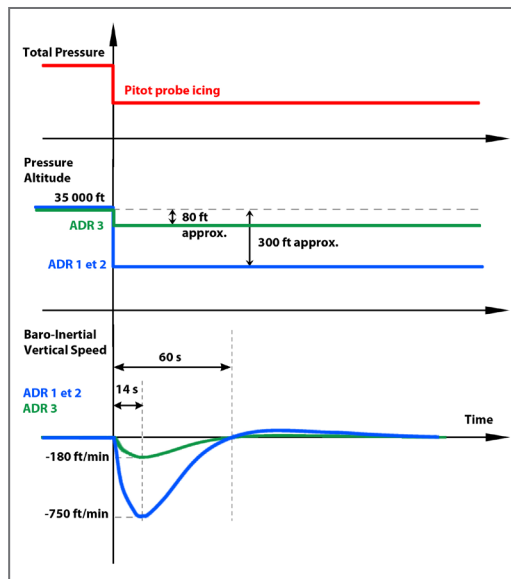

Figure 10: Effect of a drop in total measured pressure on standard altitude and vertical speed

The drop in Mach also impacts the SAT and thus the true air speed and the wind speed.

In the following table, the case an A330-200 flying at FL 350 at Mach 0.8 in standard atmosphere with a 30 kt head wind is given as an example to illustrate the consequences of Pitot icing that would result in a drop in Mach from 0.8 to 0.3.

	Real value	Indicated value
Mach	0.8	0.3
Standard altitude (ft)	35,000	≈ 34,700
CAS (kt)	272	97
SAT (°C)	-54	-31
TAS (kt)	461	182
Wind speed (kt)	-30	249

During Pitot probe de-icing, the same variations occur in the opposite direction.

1.6.10 Specific points on overspeed

Pilots consider that in-flight overspeeds constitute a serious risk. This perception of the risk has a number of origins:

- Flying theory training (notably during ATPL):
 - the danger of a “shock stall” is considered on a par with the more classical “low-speed” stall;

⁽²⁾A high speed dive phenomenon.

- the dangers associated with high speed (e.g. the onset of flutter, or the tuck-under effect⁽²⁾) are presented even though modern aircraft generally no longer suffer from these characteristics, which could indeed be hazardous on some older-design aircraft;

- ❑ VMO/MMO corresponds to an important limit in the performance and limitation curves, for airline pilots; although the “classic” stall is perceived as being fairly well known, and is experienced by pilots (at least during their initial training), excursions well above the VMO/MMO are not demonstrated in training;
- ❑ The consequences of an excursion above the VMO/MMO are quite severe for the operation of the aircraft, and may require a thorough maintenance inspection;
- ❑ The certification criteria stipulate that overspeeds should be indicated by a red ECAM message associated with a continuous repetitive chime (CRC) type alarm, whose intensity must be such that it demands an immediate reaction from the crew.

Modern aircraft with supercritical wing profiles offer numerous advantages, which include improved aircraft control characteristics at high speed:

- ❑ The position of the aerodynamic centre is virtually stable for supercritical profiles;
- ❑ The increase in the drag above a certain speed is so great that it is extremely unlikely, or even impossible, to fly faster than the demonstrated speeds that ensure the absence of flutter (VD/MD);
- ❑ Fly-by-wire systems, and the load factor limitation which may be associated with them, help to prevent the structure from being damaged by a recovery manoeuvre, even when performed forcefully.

The risk associated with low speeds is a risk of loss of control resulting from aerodynamic phenomena, whereas the risk associated with high speeds is essentially a risk of a structural overload that may, in extreme cases (e.g. a sudden recovery manoeuvre or the onset of flutter) lead to a breakup. However, in the same way that stall-related risks may vary according to the type of aircraft (e.g. susceptibility to deep stall), not all aircraft have the same characteristics at high speed and, therefore, are not exposed to the same degree of risk.

1.6.11 Angle of attack protection and stall warning

The normal law of the fly-by-wire flight control system on the A330 offers high angle of attack protection that limits it to a value that is below the stall angle of attack. When this protection works, the aeroplane can not stall even if the crew maintains a nose-up control input to the stop.

Note: At the maximum angle of attack authorized by the normal law, if a nose-up input is maintained and the thrust is not sufficient to maintain level flight, the angle of attack remains lower than the stall angle of attack and the aeroplane will descend.

In alternate or direct law, the normal law high angle of attack protection is lost but the stall warning is available. It consists of a “STALL, STALL” aural warning, followed by a characteristic cricket sound and the illumination of the Master Warning light. It is triggered by the FWC when the highest of the valid angle of attack values exceeds

the threshold set for the flight conditions at that time. If the CAS measurements for the three ADR are lower than 60 kt, the angle of attack values of the three ADR are invalid and the stall warning is then inoperative. This results from a logic stating that the airflow must be sufficient to ensure a valid measurement by the angle of attack sensors, especially to prevent spurious warnings.

On some types of aeroplanes (Airbus A320, for example), because of the aerodynamic characteristics in the approach to stall, the warning threshold is often independent of Mach and determined for low altitudes. On the A330 as on other aeroplanes of the same generation, the threshold of the stall warning varies with the Mach, in such a way that it is triggered - in alternate or direct law – before the appearance of buffet.

Note: The highest of the valid Mach values is used to determine the stall warning threshold. If no Mach is valid, the warning threshold for values below Mach 0.3 is used.

In a schematic manner, the threshold is stable below a Mach of the order of 0.3, then reduces in a quasi-linear manner to a Mach of the order 0.75, after which it falls more rapidly when the Mach increases up to Mach 0.82:

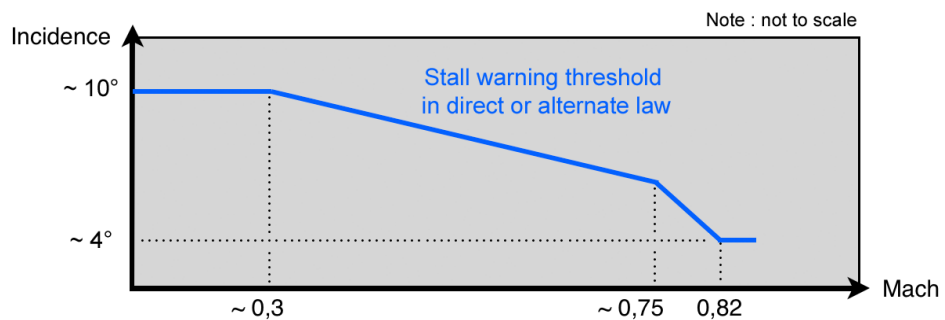

Figure 11: Evolution of stall warning threshold in relation to Mach

A decrease in speed results in an increase in the angle of attack, if the load factor is constant and in a calm atmosphere. In this case, the decrease in speed corresponding to an increase in a given angle of attack depends on the flight conditions:

Flight condition	Cruise	Takeoff / Approach
Level of decrease in indicated speed for an increase of 1° in the angle of attack	25 kt	5 kt

In cruise at Mach 0.8, the margin between the flight angle of attack and the angle of attack of the stall warning is of the order of 1.5 degrees, but the stall warning speed displayed on the air speed tape (in alternate or direct law) will be around 40 kt below the current speed.

The angle of attack is the parameter that allows the stall warning to be triggered. Its value is not directly displayed to the pilots. The activation threshold of this warning is indicated by a marker on the speed tape in alternate or direct law. When the ADR are rejected by the flight control computers, this marker disappears

1.6.12 REC MAX and OPTI flight levels

By including performance driven margins, the manufacturer defines a recommended maximum flight level, called "REC MAX", which is lower than the maximum certified flight level. It is calculated by the FMS by taking into account the following margins:

- ❑ It can be reached with a climb speed at least equal to 300 ft/min at MAX CLB thrust setting;
- ❑ It can be maintained at a speed not less than "GREEN DOT" and with a thrust setting not above the maximum cruise thrust (MAX CRZ), which is less than MAX CLB thrust;
- ❑ There is a guaranteed margin of at least 0.3 g in relation to the appearance of buffet (that's to say that buffet does not appear as long as vertical acceleration remains below 1.3 g.).

Note: The FMS does not take into account in this calculation the use of the anti-icing equipment (nacelles or wings) or the level of bleed air (hold cooling or high level rate of the a/c packs).

The manufacturer also defines an optimal flight level, called "OPT" or "OPTI", calculated by taking into account additionally the wind data and a performance parameter, entered by the crew, called the "COST INDEX". A low COST INDEX minimizes fuel consumption; a high COST INDEX favours higher speed. The OPTI is always below the REC MAX.

The value of these two levels is shown on the FMS PROG page:

Note: The operator recommends to the crews to maintain a flight level between 2000 ft above and below the OPTI. No particular reference is made to the REC MAX, however the Air France crews were used to consider having to have some margin with respect to that flight level.

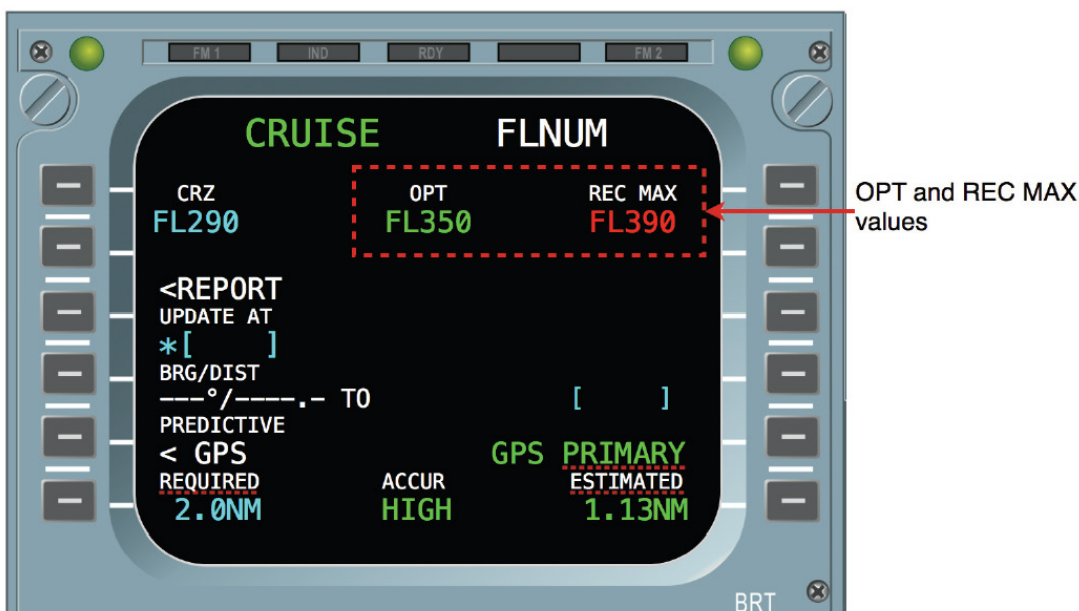

Figure 12: Example of a "PROG" page from FMS

1.6.13 Onboard weather radar

The Air France Airbus A330's are fitted with Collins WXR 700X-623 type weather radar with a flat antenna (P/N : 622-5132-623). The opening angle of the radar beam is 3.6° in elevation and 3.7° in azimuth.

Adjustments to the tilt and the gain are made manually.

Each aeroplane is equipped with two systems, only one antenna and only one control box. Only one system is active at a time.

The radar image is presented on the ND overlaid with navigation and TCAS information. It is presented when the radar is operating, when the ND is not in PLAN⁽³⁾ mode and when the TERR⁽⁴⁾ mode is not selected. Range adjustment is done manually.

Note: Adjusting the luminosity of the terrain and weather information is done independently of that of other information on each ND.

Note: The calibrated position on the gain control sets the radar sensitivity at the level of standard calibrated reflectivity.

1.7 Meteorological Conditions

1.7.1 Meteorological situation

All of the data on the meteorological research is contained in Interim Reports 1 and 2.

From a climatology point of view, the general conditions and the position of the ITCZ over the Atlantic were normal for the month of June. Cumulonimbus clusters that are characteristic of this zone were present, with a significant spatial heterogeneity and lifespan of a few hours.

Infra-red images taken every fifteen minutes by the geostationary satellite Meteosat 9 did not make it possible to directly observe the conditions encountered at FL350.

The infra-red imagery analysis does not make it possible to conclude that the stormy activity in the zone where flight AF 447 is presumed to have disappeared was exceptional in character, but it shows the existence of a cluster of powerful cumulonimbi along the planned flight path, identifiable from 0 h 30 onwards. This cluster is the result of the fusion of four smaller clusters and its east-west extension is approximately 400 km.

Though the analysis of the imagery leads one to think that, towards 2 h 00, the cumulonimbi forming this cluster had mostly already reached their stage of maturity, it is highly probable that some were the site of notable turbulence at FL350. There is a possibility of significant electrical activity at the flight level, but the presence of super cooled water at FL350 is not very probable and would necessarily have been limited to small quantities.

1.7.2 Forecast charts

The TEMSI chart for 0 h 00 (see appendix 12) shows that the planned route touches the two East-West oriented cloudy masses, located on both sides of the equator and mentions: ISOL/EMBD CB between levels XXX (base located below FL250) and FL450. The highest altitude of the tropopause along the route is estimated at FL500. A 280°/85 kt jet stream is indicated around the 10° North parallel, to the West of the route, at FL410 and FL430. The following illustration shows the superimposition of this TEMSI with the infra-red image for 0 h 00.

⁽³⁾Display mode that presents, as a fixed image, the route of the flight plan on a map oriented towards true north centred on a reference point chosen by the pilot.

⁽⁴⁾When the TERR ON ND push-button is ON, the ND displays the continuous relief contained in the EGPWS Data Base.

IR -40° du 01 juin 00 h 00 + extrait TEMSI London 01 juin 00h 00

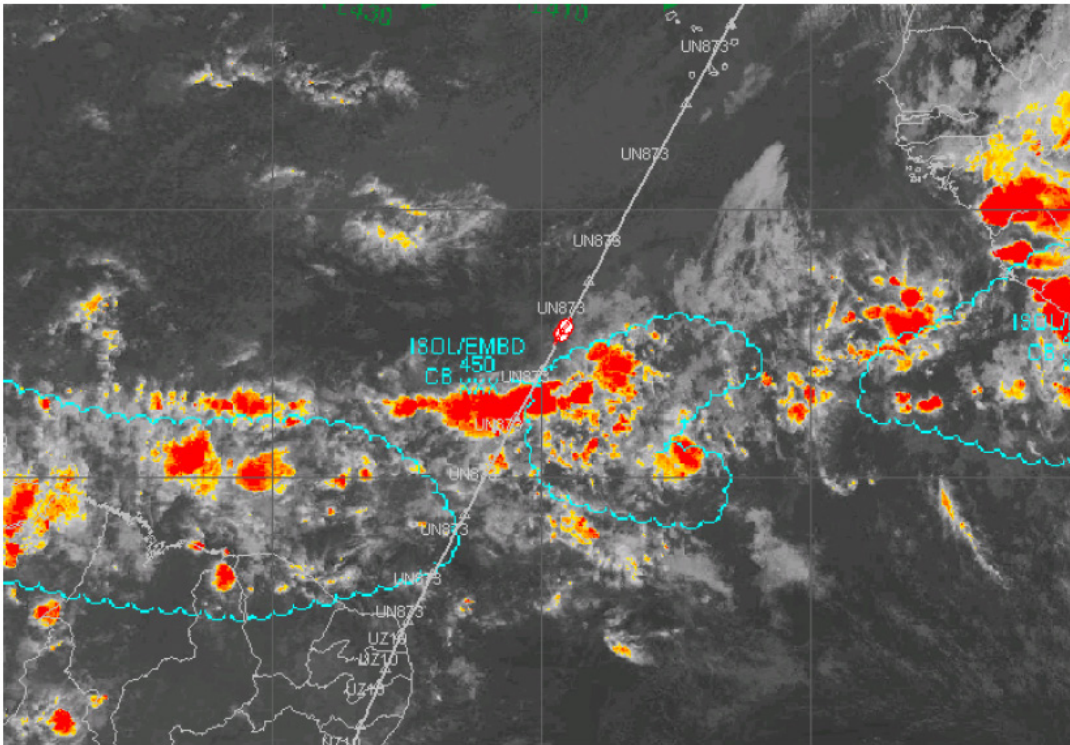

Figure 13: TEMSI chart overlaid with infrarouge image at 0 h 00

Note: The TEMSI charts and the wind and temperature charts are forecasts based on a digital model at a synoptic scale produced 24 hours before a specific validity time, for the South America region. These charts present the large convective activity zones in the area described but do not indicate the specific position of the cumulonimbi and the cumulonimbus clusters.

The wind and temperature charts show that the average effective wind along the route can be estimated at approximately ten knots tail-wind. On the chart for FL340, the highest air temperature is located around the equator. It is estimated at - 40 °C, that is to say, Standard +13 °C. The CAT charts do not forecast any clear air turbulence along the route.

1.7.3 Meteorological analyses

Though the Tropical Rainfall Measuring Mission (TRMM) lightning imager indicates an absence of lightning in the accident zone at 2 h 30, the infrared image taken at the same time is consistent with those of Meteosat 9: taken together, this information does not make it possible to conclude that there was a sudden and exceptionally intense development of the convective activity between 2 h 07 and 2 h 30.

Analysis of the observations by the TMI instrument (TRMM microwave imager), the only one operating in the microwave area, indicates the presence of strong condensation around 10,000 metres altitude, lower than the altitude of the cumulonimbus tops. This strong condensation would correspond to convective towers active at this altitude, confirming the strong probability of notable turbulence within the convective cluster that was crossed by the planned flight path of flight AF 447.

1.8 Aids to Navigation

The GNSS is the only navigation aid near the TASIL point.

At the time of the event, the GPS constellation gave the required navigation precision on the route.

1.9 Telecommunications

1.9.1 Communications between the aeroplane and the ATC centres

Flight AF 447 was under radar control from departure from Rio de Janeiro airport to the INTOL waypoint, and under radar coverage up to the SALPU waypoint (RECIFE FIR, located between INTOL and ORARO). After this point, AF 447 was under en-route control (via a flight progress strip) based on information in the flight plan updated by the crew or by exchanges between control centres.

The crew of flight AF 447 received clearances, associated with limits beyond which the aircraft could not proceed without obtaining another clearance. Generally, these limits coincide with the boundaries of FIRs or of controlled airspace. The controller of the RECIFE ACC sent the crew of AF 447 the frequencies to be used in the ATLANTICO ACC and, after TASIL, in the DAKAR Oceanic ACC. However, the controller did not provide a limit clearance before the aircraft entered Senegalese airspace in order to allow the crew of flight AF 447 to proceed with its flight in the event of the loss of radio contact.

Note: Although there was no provision for this in the letters of agreement, this practice is nonetheless commonly observed to mitigate the limitations of HF radio communications in these regions.

Note: The times mentioned come from the transcripts made by the Brazilian authority. They can be slightly different from those of the CVR transcript.

At 0 h 36 min 40, the RECIFE controller announced radar contact. "Maintain FL350. Over INTOL intersection contact ATLANTICO HF on 6535 or unable 5565. Until there, maintain this frequency". The crew read back the frequencies.

At 1 h 14 min 31, the crew announced passing FEMUR and stated they were contacting ATLANTICO via HF. The RECIFE controller asked them to wait until passing INTOL.

At 1 h 14 min 58, the RECIFE controller coordinated with the ATLANTICO controller the estimated time (INTOL) at 32 and FL350 for AF 447.

At 1 h 31 min 44, the RECIFE controller gave the crew the ATLANTICO HF frequencies: 6649 or 5565 kHz, then 6535 kHz after the TASIL point. The crew read back the three frequencies. The controller told them to contact the DAKAR controller on the 6535 kHz frequency only after TASIL.

Note: TASIL is on the boundary between the ATLANTICO and DAKAR Oceanic FIRs.

At 1 h 33 min, an attempted ADS-C connection with DAKAR Oceanic failed due to the absence of a flight plan in the Eurocat system.

At 1 h 33 min 25, the crew contacted the ATLANTICO controller on the 6649 kHz frequency.

At 1 h 35 min, a new attempted ADS-C connection with DAKAR Oceanic failed due to the absence of a flight plan in the Eurocat system.

At 1 h 35 min 15, the crew informed the ATLANTICO controller that they passed INTOL point at 1 h 33, at FL350. They gave the following estimates: SALPU at 1 h 48 then ORARO at 2 h 04. They also transmitted their SELCAL code: CPHQ. The controller updated the strip.

AFR447	FEMUR	INTOL	350	SALPU	ORARO	TASIL	0106
SBGL A3601	0115	0135	0150	0206	0221	0114	
W A332H	350	350	350	370	370	370	370
LFPG M082	M82	CPHQ	R0003	32	35	48	ACT
UN873	UN873	REG/FGZCP	SEL/CPHQ	DAT/SY	DOF/090531	S10	STP

Figure 14: Strip filled out by ATLANTICO controller

At 1 h 35 min 26, the ATLANTICO controller started coordination with the DAKAR Oceanic controller for flight AF 447 and provided him the following elements: estimated at TASIL at 2 h 20, FL350, Mach 0.82. The DAKAR Oceanic controller interrupted the communication and told him he would call back.

At 1 h 35 min 38, the ATLANTICO controller sent a SELCAL call, whose completion the crew confirmed and thanked the ATLANTICO controller.

At 1 h 35 min 46, the ATLANTICO controller asked the crew to maintain FL350 and to give an estimate at TASIL.

Between 1 h 35 min 53 and 1 h 36 min 14, the ATLANTICO controller asked the crew three times for its estimated time passing TASIL. The crew did not answer.

The radar data show that AF 447 passed over the SALPU point at 1 h 49 min, the last recorded radar point corresponding to the limit of radar coverage (this passing time would correspond to an estimated time at TASIL of 2 h 20).

At 2 h 01 min, a third ADS-C connection with DAKAR Oceanic failed because of erroneous registration information in the Eurocat system.

1.9.2 Means of monitoring used by air traffic control services

Radar is no longer the only technology capable of performing air traffic monitoring, i.e. a representation, if possible with identification, of an aircraft's position, that is regularly refreshed. The advent of satellite navigation systems and air-ground data links has led to other means and techniques.

Among these means is "dependent" monitoring: since the aircraft knows its position from its navigation systems, it can transmit this information to the ground just as it might transmit any other on-board parameter. This type of monitoring therefore fully depends on the resources on board the aeroplane. No radar is necessary; all that is required is a communication link with the ground. This system is called ADS⁽⁵⁾ and can take two forms:

- ADS-B (B for Broadcast): the position (in addition to other on-board information) is transmitted regularly without polling from the ground, with the transmission configuration set up only once. Receiver beacons on the ground within the optical range of the aircraft (250 Nm max.) are required.

⁽⁵⁾Automatic Dependent Surveillance.

- ❑ ADS-C (C for contract): the aircraft regularly reports information, including its position, via a bilateral and contractual communication with a ground facility.

1.9.2.1 Functioning of ADS-C / CPDLC

Establishing the connection (contract) in flight

A connection (logon) is a pre-requisite for the operation of CPDLC and/or of ADS-C. This logging-on process opens a channel of communication between the aircraft and the ATS system which will then be used to convey the CPDLC and/or ADS-C information. To establish this connection, the aircraft sends its flight number and registration so that the ATS system can check the consistency of this data against the flight plan. The aircraft is then identified by the ATS system and the connection is established.

The pilot initiates the first flight logon with a manual procedure.

➤ ADS-C

The introduction of ADS-C increases the monitoring capacity for Oceanic or continental en-route airspaces, and is intended to replace the position report in the airspaces where non-radar separation is applied.

In non-radar airspace, or where HF communication is difficult, the alert service may be provided via the ADS-C contract.

➤ CPDLC

CPDLC is a technology that makes it possible for air controllers and pilots to communicate directly over a datalink system. The messages exchanged between the two parties are selected from a sub-set of messages, in general reproducing all of the aeronautical phraseology. This system overcomes several problems inherent to voice transmission (message deformation, poor pronunciation, etc.) and to the transmission or reception of messages (frequency band saturation, poor propagation of radio waves, etc.).

1.9.2.2 The EUROCAT-X system used by DAKAR

Eurocat is an air traffic management system that was used on an experimental basis by DAKAR Oceanic at the time of the accident. It includes various alerts that are presented to controllers, whose threshold parameters are modifiable, such as:

- ❑ CLAM (Clearance Level Adherence Monitoring): if the aircraft's altitude deviates from the authorised flight level;
- ❑ RAM (Route Adherence Monitoring): if the aircraft has deviated laterally from the route assigned to the flight plan;
- ❑ ETO (Estimated Time Overflight): if the times reported differ from those estimated by the FDPS.

The illustration below shows the air traffic as displayed to the DAKAR Oceanic controller by the Eurocat system (in this case, the situation on 1st June 2009 at 3 h 41 min 19 s).

Note: An aircraft may appear simultaneously on DAKAR and ATLANTICO. It may be logged on to and transmit via ADS-C with 3 centres simultaneously.

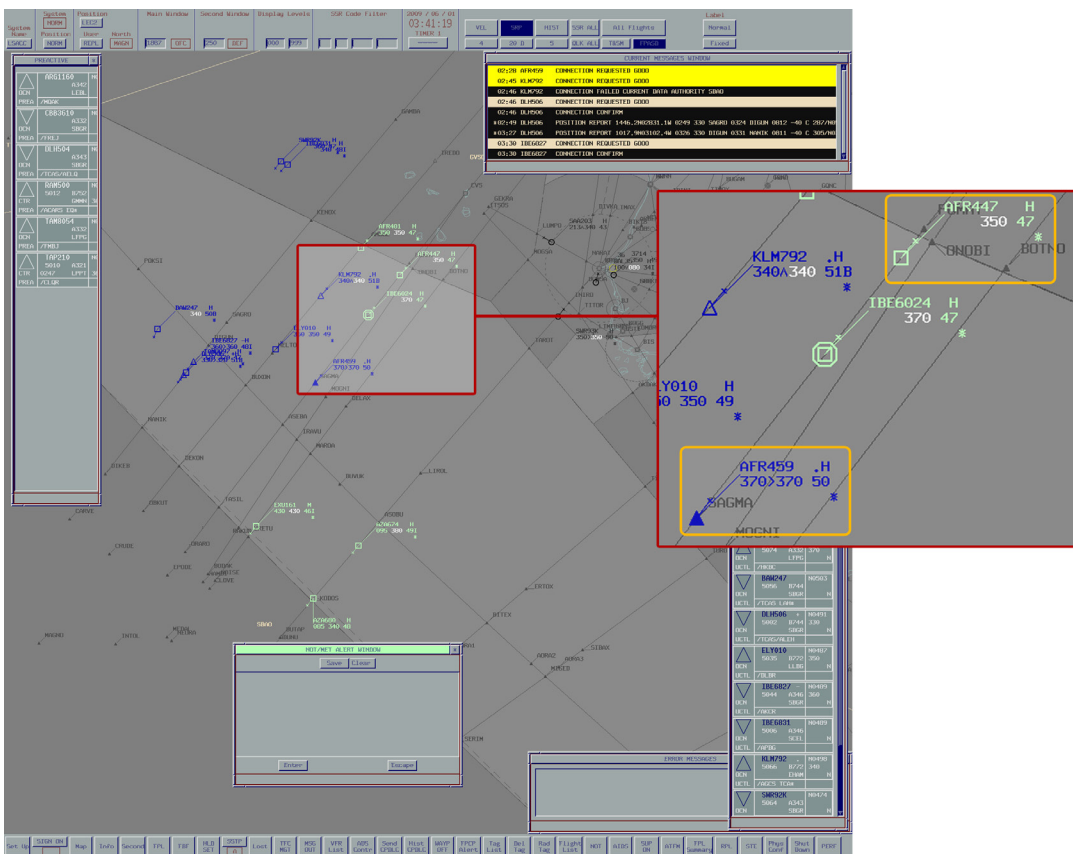

Figure 15: Representation of air traffic by the Eurocat system

Following the coordination of flight AF 447 data with the ATLANTICO controller, and since the flight plan was absent in the Eurocat system, the DAKAR Oceanic controller created the flight plan in Eurocat. Consequently, the track appeared on the screen, and a strip was transmitted.

On the illustration, flight AF 447 appears as a green square. This symbol indicates that a flight plan (square) was accepted by the controller (green). In an operational context, the concept of an “accepted” flight means that the controller takes responsibility for controlling and monitoring this flight. The acceptance of the flight enables the monitoring functions described previously.

In comparison, flight AF 459 is symbolised as a solid blue triangle. This means that:

- The aircraft is logged-on to ADS-C (triangle);
- The aircraft is transmitting its position (solid triangle);
- The aircraft has not yet been accepted by the controller (blue).

➤ **Reasons for rejection of the flight’s logon**

The first two logon attempts were rejected due to the absence of the flight plan for AF 447 in the Eurocat system. Following coordination between the controllers, the third attempt was rejected because the flight plan did not include the complete registration for flight AF 447.

1.9.3 Coordination between the control centres

At 1 h 46, the DAKAR controller asked the ATLANTICO controller for further information regarding flight AF 447 since he had no flight plan. The ATLANTICO controller provided the following elements: A332, from SBGL to LFPG, SELCAL: CPHQ.

The DAKAR OCEANIC Regional Control Centre created the flight plan and activated it. The result of this was to generate a virtual flight following the planned trajectory in the DAKAR FIR between TASIL and POMAT. There was no radio contact between AF 447 and DAKAR, nor any ADS-C connection. The flight remained virtual.

At 2 h 47 min 00, the DAKAR controller coordinated flight AF 447 by telephone (ATS/DS) with the SAL controller (Cape Verde) with the following information: passing the POMAT point (leaving the DAKAR FIR) estimated at 3 h 45, FL350, Mach 0.82.

At 2 h 48 min 7, the DAKAR controller told the SAL controller that flight AF 447 had not yet established contact with him.

At 3 h 54 min 30, the SAL controller called the DAKAR controller by telephone (ATS/DS) to confirm the estimated time for passing the POMAT point. The latter confirmed that POMAT was estimated at 3 h 45. The DAKAR controller stated that the crew of flight AF 447 had not contacted him to correct its estimate. The SAL controller replied that the estimate was probably later. He asked the DAKAR controller if there was any change. The DAKAR controller then said that he was going to try to contact flight AF 447.

At 4 h 7 min 4, the SAL controller requested confirmation of the flight AF 447 estimate. The DAKAR controller confirmed again that POMAT was estimated at 3 h 45. The SAL controller pointed out that it was 4 h 08 and that the estimate was not correct. The DAKAR controller recalled that contact had not been established with flight AF 447. The SAL controller stated that he had identified flight AF459 on his radar whereas its estimate was later than that of flight AF 447. The SAL controller said that he thought that the POMAT estimate was later, at 4 h 29 or 4 h 30. The DAKAR controller told the SAL controller that he would call him back.

At 4 h 11 min 53, the DAKAR controller asked flight AF 459 to contact flight AF 447.

At 4 h 20 min 27, the crew of AF459 informed the controller that they were passing point POMAT at FL370. They had not succeeded in contacting flight AF 447 and said that they had sent a message to Air France so that the airline should try to contact flight AF 447.

At 4 h 21 min 52, the DAKAR controller asked the ATLANTICO controller to confirm that flight AF 447 had passed TASIL at 2 h 20 at FL350. The ATLANTICO controller confirmed that TASIL was estimated at 2 h 20 but that no contact had been made.

At 4 h 37 min 7, the DAKAR controller asked the SAL controller if he had still not been able to contact flight AF 447 and informed him that, according to the ATLANTICO controller, the flight should have left the FIR at 2 h 20 and consequently the POMAT estimate should be 3 h 45.

At 4 h 39 min 42, the DAKAR controller asked the ATLANTICO controller to confirm that he had not had contact with flight AF 447. The latter replied that he had not had contact at TASIL but that the first contact was at INTOL at 1 h 33. The DAKAR controller told the ATLANTICO controller that SAL had not established contact either. The ATLANTICO controller said that he would call again later.

At 4 h 52 min 36, the DAKAR controller called the SAL controller again to ask him whether he had established contact. He confirmed the estimates at the limits of the FIR and asked the SAL controller to call him again if he established contact.

At 4 h 53 min 50, the ATLANTICO controller called the DAKAR controller again. He told him that he would re-check the estimates and call him again.

At 5 h 1 min 34, the DAKAR controller asked the CANARIAS controller if he was in contact with AF 447. The latter replied that he had no information.

At 5 h 6 min 17, the SAL controller asked the DAKAR controller if he had a position report for flight AF 447 at the boundary with the ATLANTICO FIR. The latter replied that he had not.

At 5 h 9 min 15, the ATLANTICO controller asked the DAKAR controller if he had any news of flight AF 447. The DAKAR controller replied that he hadn't and then the ATLANTICO controller requested confirmation that the flight was already in the SAL FIR. He also confirmed that SAL had not established contact with flight AF 447.

At 6 h 05 min 13, the ATLANTICO controller asked the DAKAR controller if AF 447 had established contact with SAL. The DAKAR controller told him no.

The continuation of the exchanges between the control centres is in paragraph 1.15.

1.10 Aerodrome Information

The support aerodromes for this ETOPS 120 minute flight were: Natal (Brazil) and Sal Amilcar (Cape Verde).

1.11 Flight Recorders

In accordance with the regulations in force, the aeroplane was equipped with two flight recorders:

➤ Flight Data Recorder - FDR

- Manufacturer: Honeywell;
- Model: 4700;
- Part number (P/N): 980-4700-042 (source: Air France);
- Serial number (S/N): 11469 (source: Air France);
- CSMU type number: 617-6096-014;
- CSMU serial number: 14272.

This is a solid state flight data recorder (SSFDR) with a recording capacity of at least twenty-five hours. The decoding document, supplied for this aeroplane, gives around 1,300 parameters.

➤ Cockpit Voice Recorder - CVR

- Manufacturer: Honeywell
- Model: 6022
- Part number (P/N): 980-6022-001
- Serial number (S/N): 12768
- CSMU type number: 617-6096-006
- CSMU serial number: 32812

This is a solid state cockpit voice recorder (SSCVR) with a recording capacity of at least two hours in standard quality and thirty minutes in high quality.

Both recorders were equipped as provided by the regulations with underwater locator beacons (ULB) whose transmission time is at least 30 days, on the 37,5 kHz frequency.

Note: The ULB manufacturer stated that their transmission time was of the order of forty days.

1.11.1 Flight recorder opening operations and read-out

The two flight recorders arrived at BEA headquarters on 12 May 2011.



Figure 16: FDR



Figure 17: CVR

For the FDR, only the protected unit (CSMU or memory module) was present. The CVR was complete.

► Flight Data Recorder (FDR)

The CSMU was opened and the various internal thermal protective layers were removed. The memory board was extracted, and its protective coating removed.

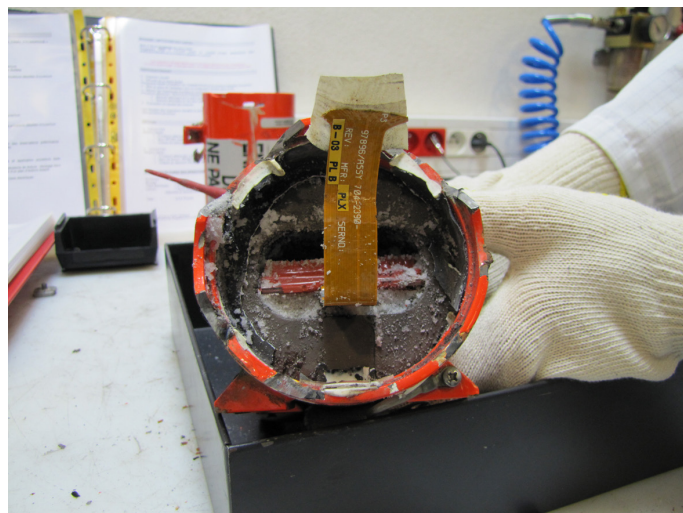

Figure 18: FDR CSMU after removal of cover



Figure 19: FDR memory board



Figure 20: Removal of internal protective layers

The memory board was cleaned. Visual inspection did not reveal any damage to the board. The board was placed in an oven for 36 hours in order to remove the moisture in the components and the printed circuit board. The impedance measurements that were then made on the input connector were in accordance with the measurements made on reference units.

The memory board was then connected to the BEA's memory reader. Each memory component was addressed individually and read in its entirety. Analysis of the binary contents confirmed that the reader communicated correctly with the memory components and that the data extracted from each memory component was consistent. The memory board was then connected to the BEA's chassis and the data was extracted using the manufacturer's official hardware. The data was synchronised and the event flight was identified.

⁽⁶⁾The CVR's data storage medium consists of two interlinked memory boards.

► **Figure 21: Cockpit Voice Recorder (CVR)**

The CSMU was released from its chassis and opened. As with the FDR, the various layers of thermal protection were removed, the double memory board⁽⁶⁾ was extracted, and then the protective covering was peeled off.



Figure 21: Opening of CVR CSMU



Figure 22: CVR memory board after removal of thermal protections



Figure 23: CVR memory boards before cleaning

Visual inspection of the boards revealed damage: a capacitor and a resistor were cracked on one of the boards; two decoder-type components were damaged on the other board.

The boards were placed in an oven for 42 hours. The damaged components were unsoldered and replaced. The impedance value measured at the input connector complied with the measurements made on reference boards. The memory boards were then connected separately to the BEA's memory reader. A few memory components selected previously were addressed and read entirely. The consistency of the binary contents of each memory could then be checked using the manufacturer's hardware and software. The boards were then connected to the BEA's chassis and the data was extracted and decompressed using the manufacturer's official hardware.

The following tracks were recorded:

- ❑ Track 1: radio communications and the signal from the microphones for the pilot seated on the left;
- ❑ Track 2: radio communications and the signal from the microphones for the pilot seated on the right;
- ❑ Track 3: radio communications, the signal from the second copilot's microphone (rear seat), and the FSK signal;
- ❑ A track made up from the first 3 tracks mixed together;
- ❑ CAM track: the signal from the cockpit area microphone.

Analysis of the 5 audio files downloaded revealed that the event did not occur at the end of the sequence of data recorded on the 5 tracks, and that the tracks were a few dozen seconds shorter than expected.

Synchronisation of the various channels showed that some of the data was missing. Moreover, analysis of the binary contents of the EEPROM memory confirmed the inconsistency of the pointers⁽⁷⁾ used by the manufacturer's reader to start and end the downloading of the data.

The method subsequently adopted to recover all the saved data involved reading the binary contents of each memory component using the BEA's memory reader. By analysing the binary contents of the memory components, the value of the various pointers could be determined. These pointers were then used to reconstruct the file in its correct chronological order. The files compressed in the manufacturer's format were reconstructed using software developed by the BEA based on information provided by the manufacturer. The files were then decompressed using the manufacturer's official hardware and software.

The 5 audio tracks obtained in this way were synchronised and their duration was found to comply with the expected values: more than 30 minutes for tracks 1 to 3 and more than 2 hours for tracks 4 and 5.

1.11.2 Analysis of the flight recorder data

➤ Synchronisation of the recorders

The recorders were synchronised using the various alarms triggered during the flight, particularly the stall warning. The number of alarms made it possible to synchronise the recorders with an accuracy of approximately 100 ms.

A synchronisation of the FDR / CVR parameters is included in appendix 3.

⁽⁷⁾Information indicating the position of an item of data in a binary file.

➤ **CVR analysis**

The CVR recording started at 0 h 09 min 15 and stopped at 2 h 14 min 28.4.

The following points are of particular note:

- ❑ A call signal sounded in the crew flight rest facility at 1 h 56 min 06;
- ❑ The relief pilot entered the cockpit at 1 h 59 min 26;
- ❑ The Captain left the cockpit at 2 h 01 min 58, and the door closed;
- ❑ The aural autopilot disconnection warning (cavalry-charge) was heard at 2 h 10 min 04.6;
- ❑ A first cabin crew or flight rest facility call (high-low chime) was heard at 2 h 10 min 53.5;
- ❑ Vibration noises were heard in the cockpit from 2 h 10 min 54 until 2 h 12 min 57;
- ❑ Five call signals were transmitted to the crew rest facility between 2 h 11 min 09.8 and 2 h 11 min 27;
- ❑ The Captain returned to the cockpit at 2 h 11 min 42.5.

Analysis of the noises heard in the cockpit brought to light a movement of the left seat, after the relief copilot took over, of the same duration (two seconds) as a movement heard before the Captain left the seat.

➤ **Conduct of flight and navigation**

The aircraft took off from Rio de Janeiro at 22 h 29 on 31 May. Auto-pilot 2 was engaged at about 22 h 33. The aircraft climbed gradually to flight level 350, reached at about 23 h 00.

The flight followed the planned route in modes ALT CRZ / NAV.

➤ **Turbulence**

Analysis of the recorded normal load factor revealed zones of slight turbulence. The table below provides a summary of this analysis. The values of the variations in normal acceleration correspond to the gap between the maximum and minimum values in the zone.

Note: According to ICAO, "light" turbulence is defined as being changes in the normal load factor at the centre of gravity of less than 0.5 g peak to peak.

Start	End	Duration	Amplitude
22:30	23:45	1h15	≤0,2
23:45	1:02	1h17	calm
1:02	1:32	30 min	≤0,15
1:32	1:36	4 min	0,2
1:36	1:45	9 min	≤0,1
1:45	1:48	3 min	0,2
1:48	1:52	4 min	0,3 – 0,4
1:52	2:02	10 min	≤0,15
2:02	2:07	5 min	increase from 0,1 to 0,25
2:07	2:10	3 min	maximum 0,5

Figure 24: Level of turbulence observed during flight

► Speed parameters

The calibrated airspeed recorded on the FDR is that displayed on the left-hand PFD. If it is invalid (speed less than 30 kt, SPD flag displayed on the speed tape), the airspeed recorded is that displayed on the right-hand PFD. This change in the source of the recorded parameter is not explicit. If both airspeeds are invalid, the SPD flag appears on each side and the airspeed recorded is then also invalid, with an NCD status. Its variation then follows a specific profile.

Note: The airspeed displayed on the left-hand PFD is generally derived from ADR1, but may also be derived from ADR 3, if the "AIR DATA" rotary switch located on the central console is actuated.

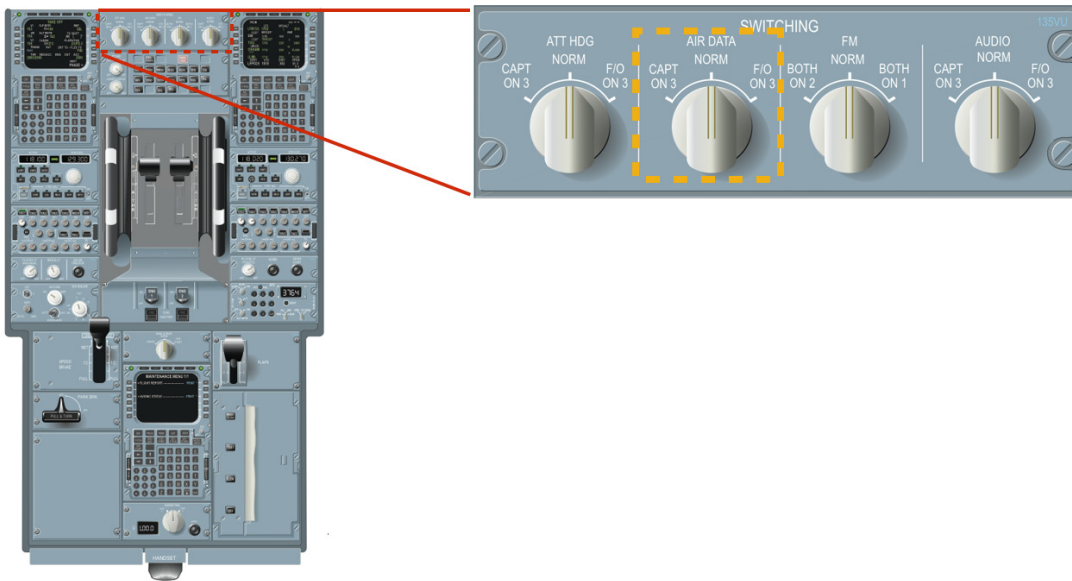

Figure 25: Position and detail of "AIR DATA" selector

The airspeed displayed on the ISIS is also recorded by the FDR. This is comparable with the calibrated airspeed derived from ADR 3, since ADR 3 and the ISIS use the same external sensors (refer to 1.6.6.1). It is always considered valid, even at airspeeds of less than 30 kt, as long as the dynamic pressure (total minus static) does not fall below a certain threshold. If this threshold is reached the SPD flag is displayed on the ISIS speed tape, the airspeed is invalid with an FW (failure warning) status and a message is sent to the CMC.

Note: Between 0 and 30 kt, the minimum value of 30 kt is displayed on the ISIS speed tape.

The Mach from the ADR which provides information to the left-side PFD is also recorded. It is only displayed on the PFD when it is greater than 0.5.

► ISIS parameters

In addition to the airspeed, the inertial parameters and the altitude displayed by the ISIS are also recorded. It should be noted that the ISIS has its own inertial measurement unit; whereas it is fed by the external aerodynamic sensors which also provide pressure data for ADR 3.

► Warnings

Aural warning triggering (altitude alert and stall warning) was correlated with the recorded parameters (see also 1.16.3.2) and demonstrated nominal functioning.

► Parameters linked to the flight directors

The recorded parameters do not reflect the state of the FD 1 and 2 selection pushbuttons located on the Flight Control Unit (FCU), but the state of the respective FD crossbars display on the PFD. The evolution of these parameters in relation to time shows several changes of state that are so simultaneous that they indicate that the FD's were never disengaged by the use of the pushbuttons. Thus it is to be noted that the FD crossbars disappeared and reappeared several times during the flight.

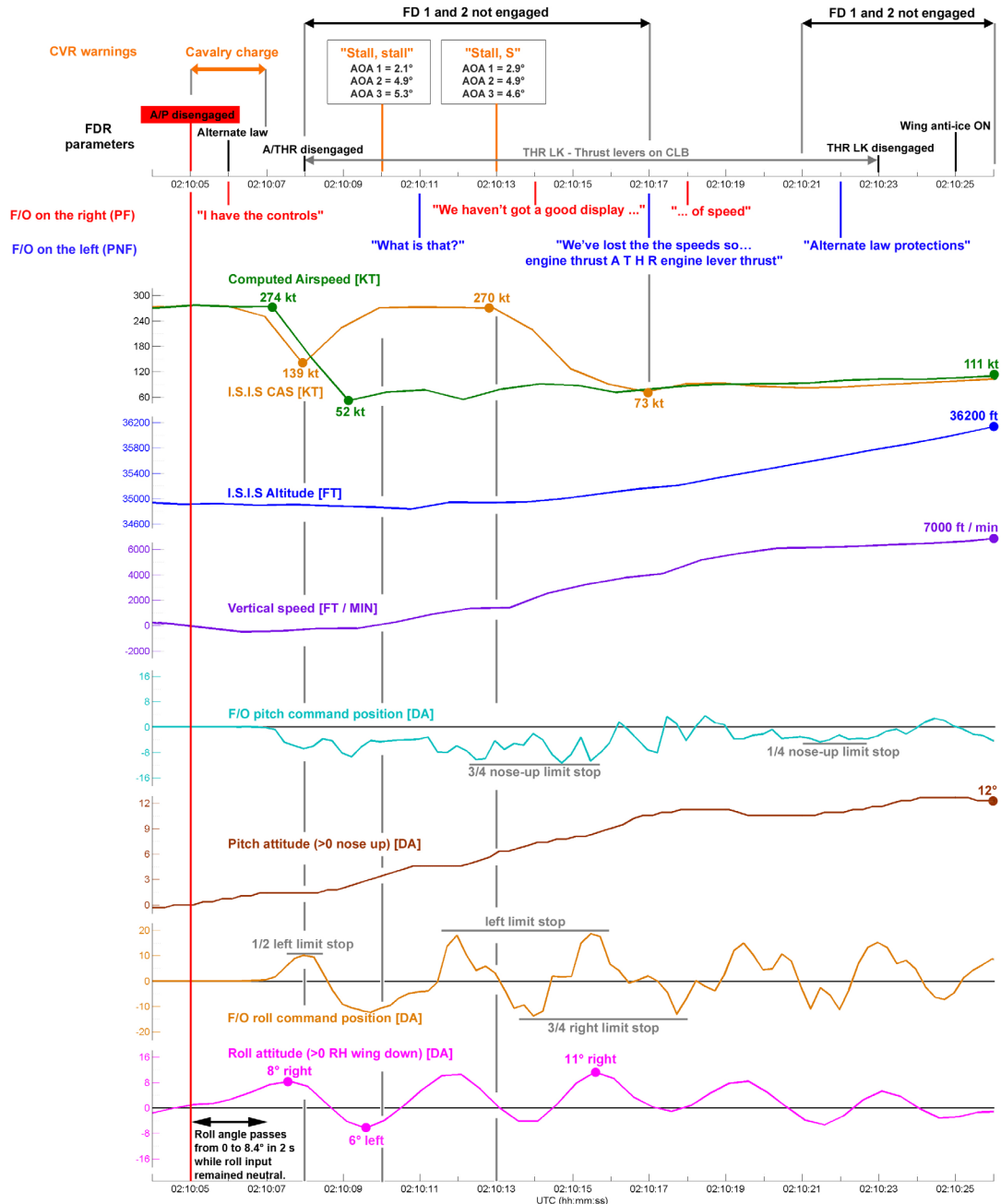

Figure 26: Parameters from 2 h 10 min 04 to 2 h 10 min 26

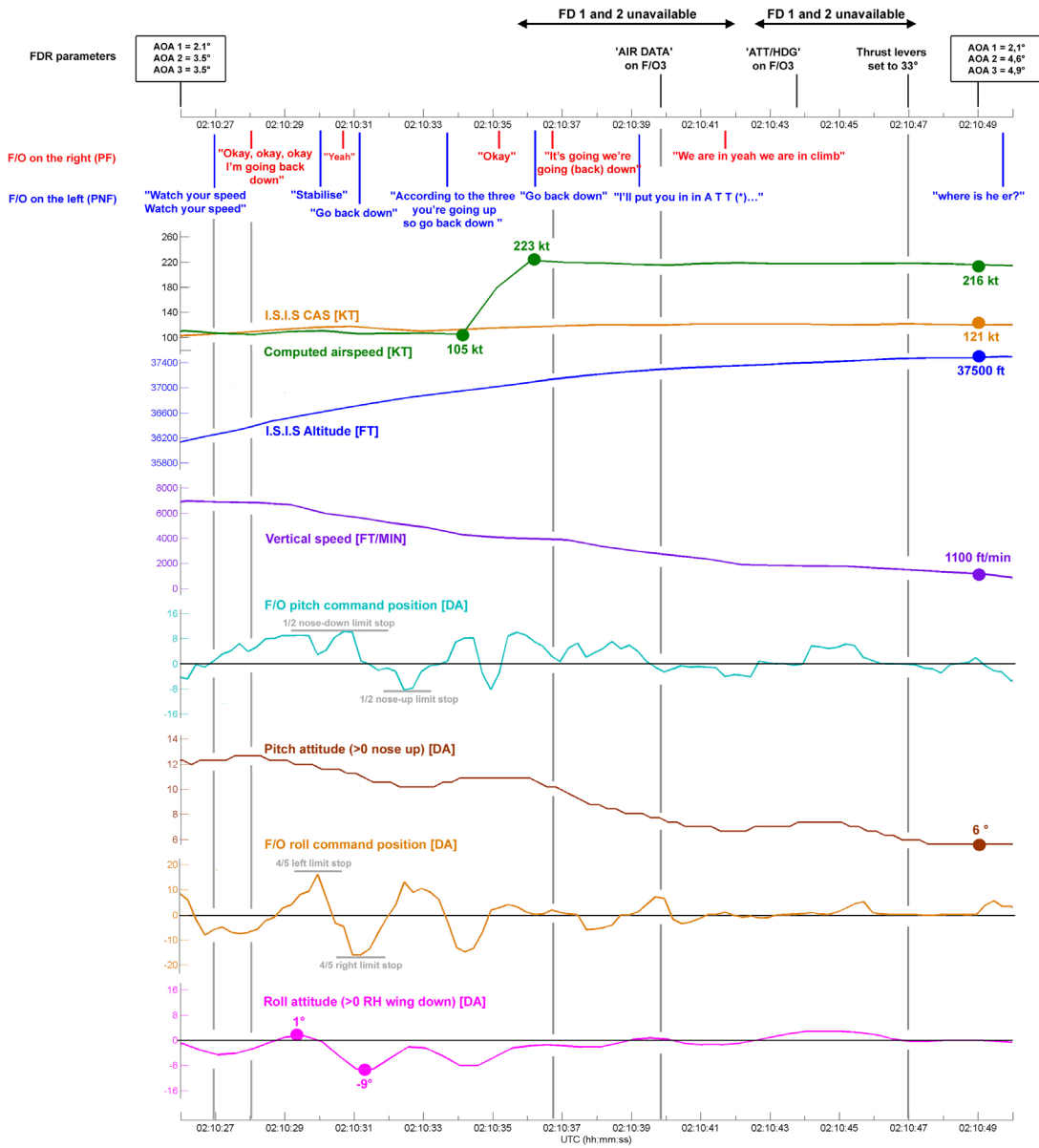

Figure 27: Parameters from 2 h 10 min 26 to 2 h 10 min 50

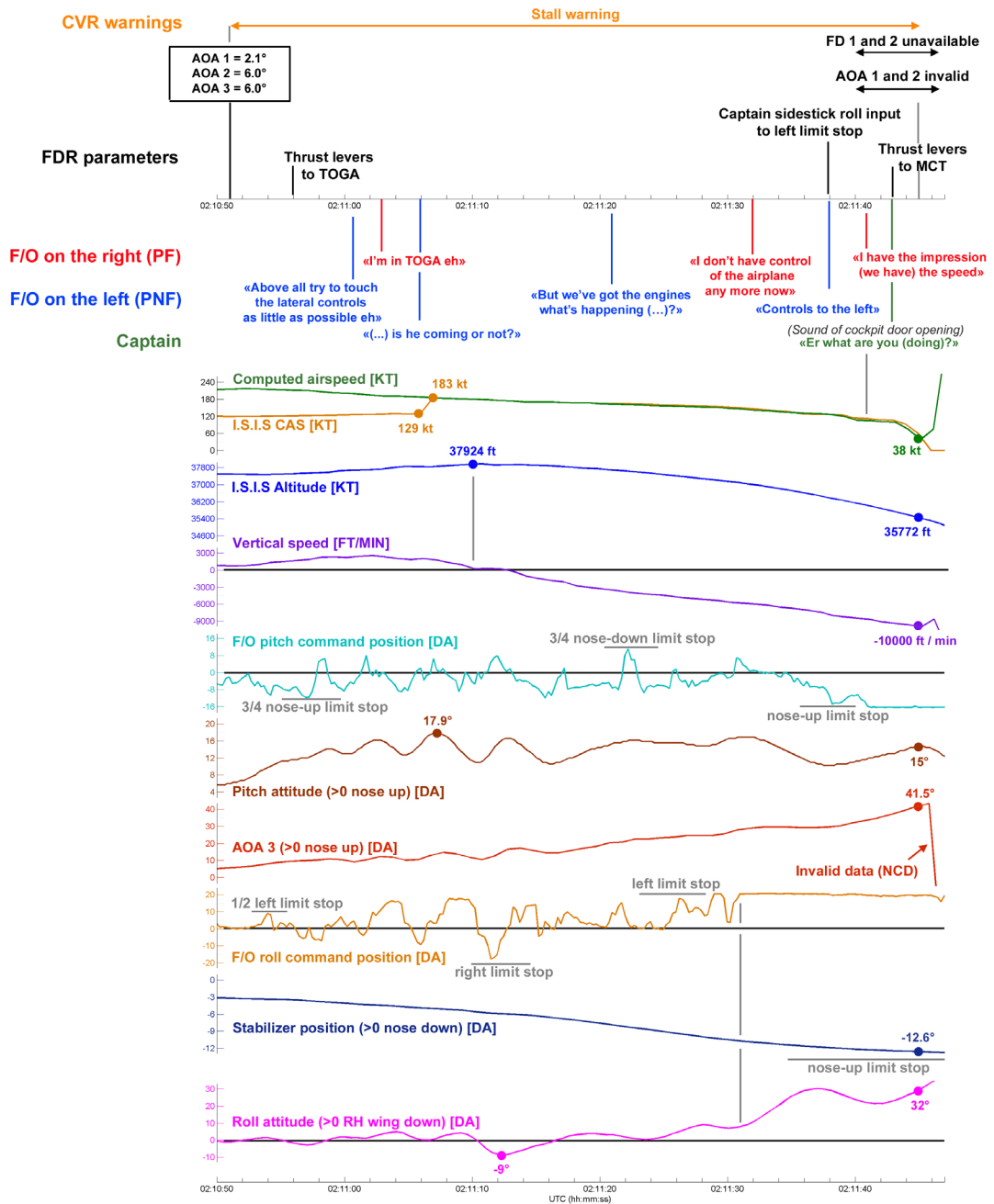

Figure 28: Parameters from 2 h 10 min 50 to 2 h 11 min 46

1.11.3 Analysis of computers

During the sea search operations conducted in 2011 that succeeded in locating the crash site and allowed the subsequent recovery of the flight data recorders, various computers were able to be recovered and identified. The ISIS, FCDC, eQAR and FMGEC computers were examined.

➤ ISIS

This computer was opened and the memory components containing the failure messages were extracted and then read using BEA laboratory hardware. The data was decoded in conjunction with the manufacturer of the equipment.

The data recovered covered only the last two minutes of the flight, and each recorded failure message indicated an inconsistency in the measurement of the difference between the total pressure and the static pressure. These messages were correlated with the data from the FDR and correspond to the periods during which the speed information provided by the ISIS was invalid.

➤ **FMGEC 1 and 2**

The two computers were examined and the data from the various memory components were read out. The failure messages recorded by each of the functions of the two FMGEC's were decoded and analysed. They are not accurately time-stamped, and had to be correlated with the data from the CVR and the FDR to refine their timing.

Analysis of the messages notably enables determination of the validity, as seen by the FMGEC, of certain computers, particularly the ADR and IR modules of each of the ADIRU's.

Thus, as the Pitot probes iced-up or de-iced, inconsistencies developed between the airspeeds calculated by each ADR and the baro-inertial vertical speeds (Vzbi) calculated by each IR. The information about the validity of the ADR and IR modules was useful in determining the status of the various Pitot probes, explaining the unavailability of the flight directors, and helping to determine the parameters displayed on the right-side PFD.

➤ **eQAR**

This computer is an unprotected parameter recorder used for flight analysis purposes by the operator. The data was recorded on a magneto-optical disk which was removed from the computer. The disk was so badly damaged that it was impossible to use traditional reading methods. It was therefore examined in collaboration with the solid-state physics laboratory at Paris-Sud University, and in conjunction with the manufacturer, Thales.

Readable zones were identified. The only zone likely to contain flight data was analysed. It relates to one second of information recorded every 100 seconds. Very little information could thus be recovered, and this data did not supplement the elements recovered by other means. The examination was therefore terminated after this feasibility study.

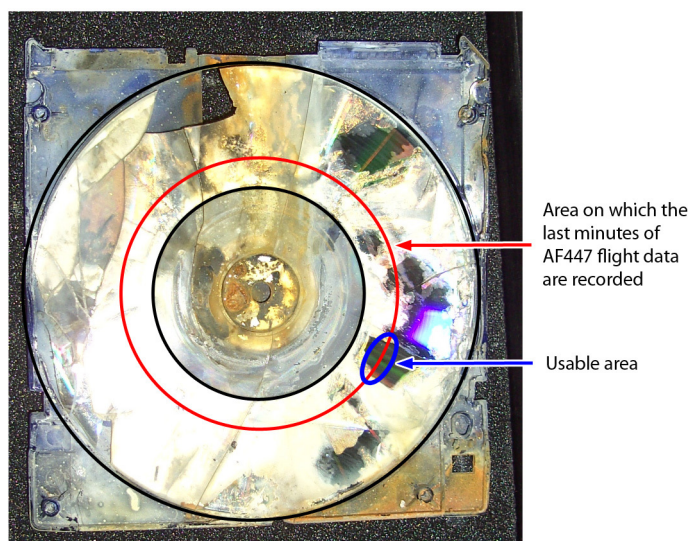

Figure 29: Optical disk showing the location of the readable zones

► FCDC

The two computers were examined. The memory components containing the data were damaged. One of the components had been torn out and the other suffered from internal short-circuits. The work was brought to a conclusion.

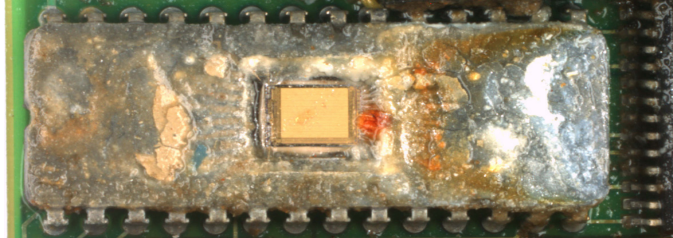

Figure 30: Memory component from one of the FCDC

1.12 Wreckage and Impact Information

1.12.1 Localisation of the floating debris and the wreckage site

The French and Brazilian navies found debris belonging to the aeroplane from 6 June onwards. All the debris was referenced in a database that includes about 1,000 aeroplane parts.

Almost all of the aircraft debris was identified and classified by type: cabin, cargo compartment, wing, belly fairing, LDMCR (Lower Deck Mobile Crew Rest). This information completed the position, date and recovery time data that had been referenced previously.

Most of the parts found were low-density honeycomb or composite material parts.

They were identified:

- Either directly with the Part Number when this was identifiable;
- Or indirectly by analysing the shapes, materials, coating colours and manufacturer's documentation when the Part Number was not available.

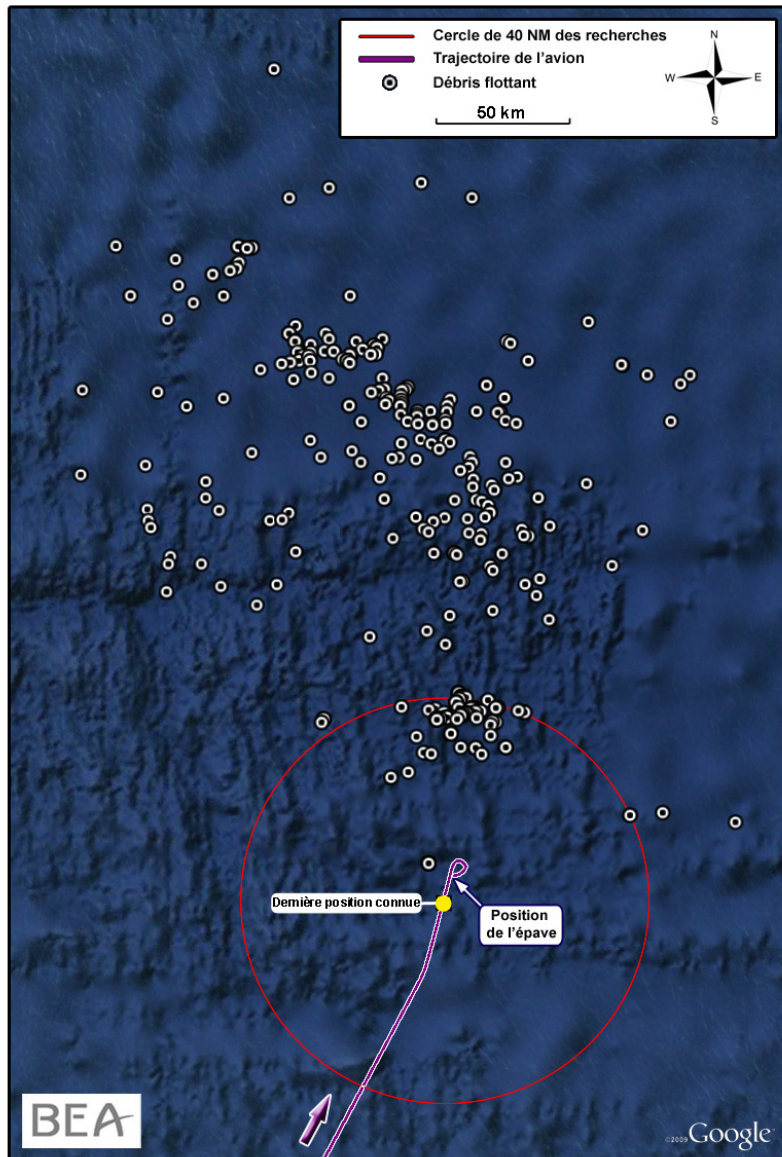

Figure 31: All of floating debris (found between 6 and 26 June), last known position and wreckage site

The wreckage was localised on 2 April 2011 during the fourth phase of the sea searches.

The site of the accident was east of the Mid-Atlantic ridge, in a region with rugged terrain and whose ocean bed presents great variations in depth over short distances of between 700 metres and 4,300 metres.

The aeroplane wreckage was found about 6.5 NM on the radial 019 from the last known position, slightly to the left of the planned route. The wreckage rested on an abyssal plain at a depth of 3,900 metres. This plain, surrounded by terrain, made of clay type sediment, was around 15 km wide and was located west of the scheduled aeroplane flight path.

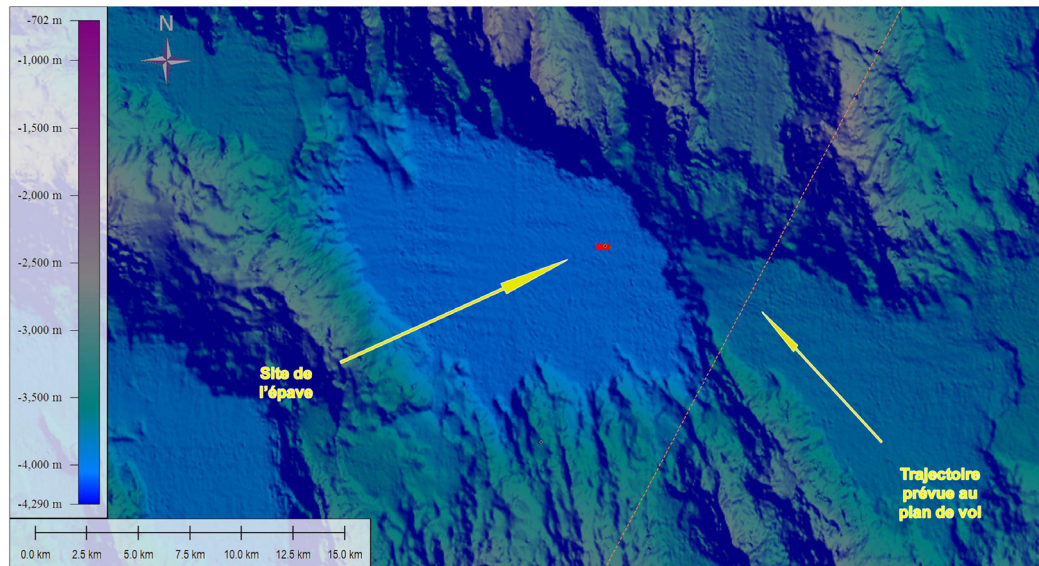

Figure 32: Wreckage localisation

1.12.2 Work performed on floating debris

During 2009, the floating debris was positioned based on the aeroplane layout and some visual examinations.

1.12.2.1 Repositioning of the debris according to the aircraft layout

All of the debris was gathered in a hangar at the DGA-Techniques Aéronautiques (former CEAT). Most of the debris could be positioned precisely in relation to the aircraft layout.

This repositioning provides a distribution of the debris:

- From the forward (radome) to the aft end (vertical stabiliser) of the aircraft;
- From the left- to the right-hand side of the aircraft for the cabin or wing parts.

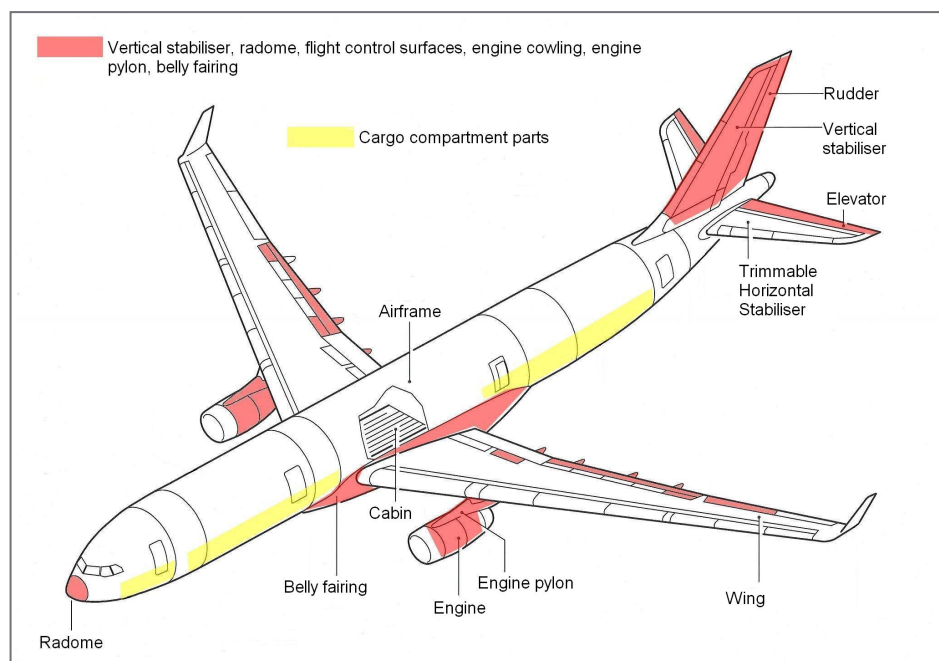

Figure 33: Position of the recovered parts (exterior and cargo)

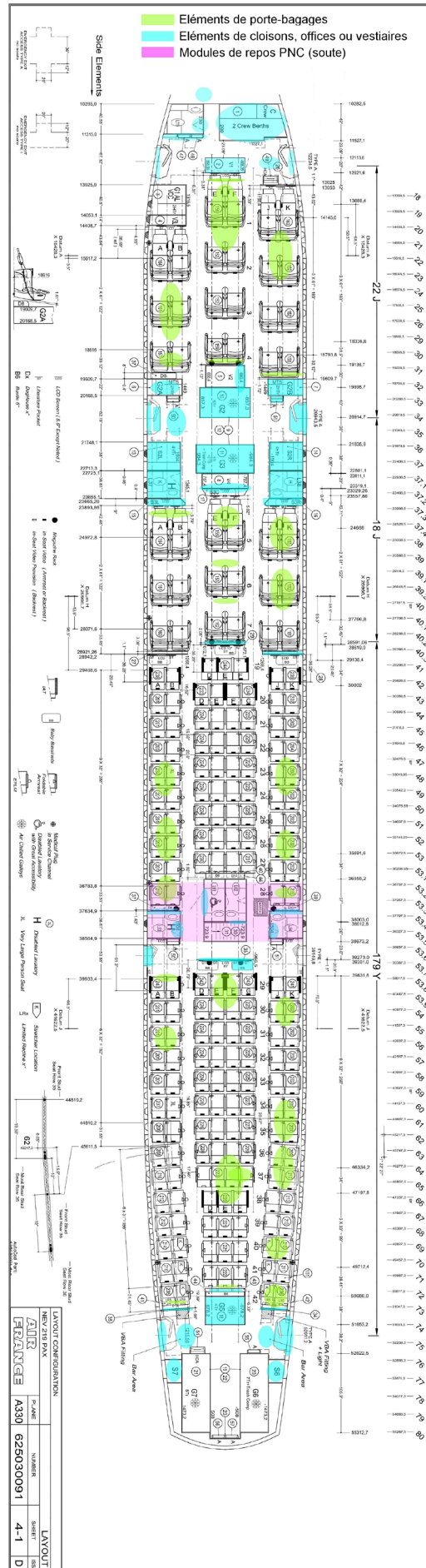

Figure 34: Position of the cabin part debris recovered in relation to the aircraft layout

1.12.2.2 Visual examination of cabin parts

A high degree of vertical compression can be seen on the cabin parts such as the galleys, stowage, partitions and toilet doors. This vertical compression is observable from the front to the rear of the aircraft, and from the right- to the left-hand sides.

The overhead luggage rack attachment fittings had deformations that are due to vertical compression and to a forward movement of the luggage racks.

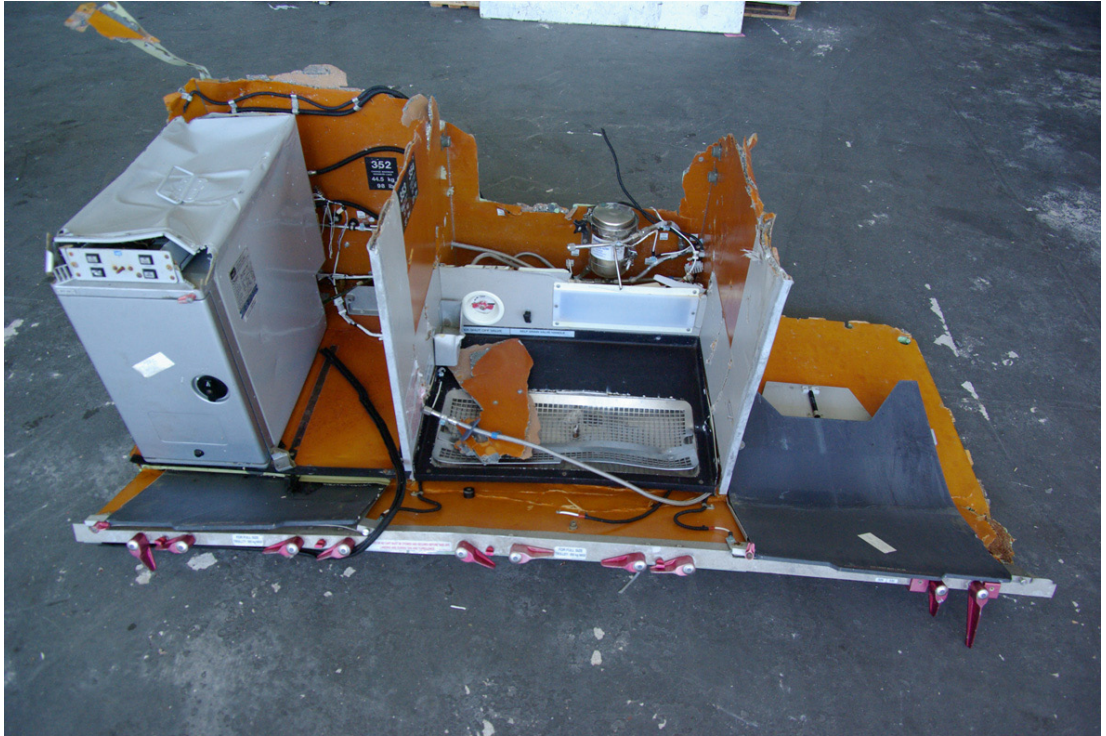

Figure 35: Part of Galley G3: downwards deformation at the level of the galley's heavy parts

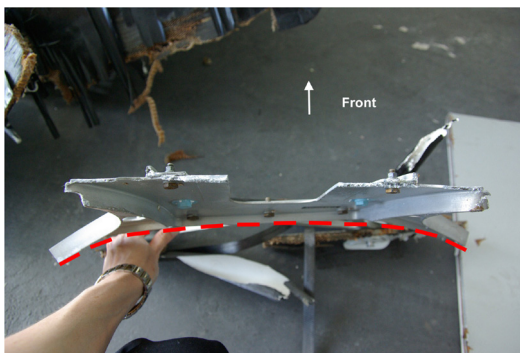

Figure 36: Luggage rack fitting deformed towards the front Toilet door (L54)



Figure 37: Metallic stiffeners deformed by buckling

1.12.2.3 Visual examination of cargo bay parts

The outer parts making up the LDMCR were all found.

The wall fragments were crumpled. The reconstitution of the ceiling showed it was bent downwards and the floor bent upwards.

These deformations were symmetrical on the left and right sides with respect to the aircraft centreline.



Figure 38: Floor of the LDMCR:
with bottom-upwards deformation



Figure 39: Ceiling of the LDMCR:
with top-downwards deformation

1.12.2.4. Examination of the passenger oxygen containers

The passenger oxygen containers were all of the same type, with two, three or four oxygen masks depending on their position in the aircraft. Twenty-nine containers were found in the debris.

The deformations observed on three of them showed that they were in the closed position.

Note: The supply system for cabin oxygen is designed to trigger the simultaneous opening of all the containers in case of depressurisation. A test was carried out on F-GZCP in July 2008 during a type C overhaul. This test showed no malfunctions.



Figure 40: Passenger oxygen container recovered closed:
the deformations on the cover matched those on the box

In normal operation, the oxygen is sent to the mask when the passenger releases the system's lock-pin by pulling on the mask. Several pins were found in place, closing the oxygen circuit.

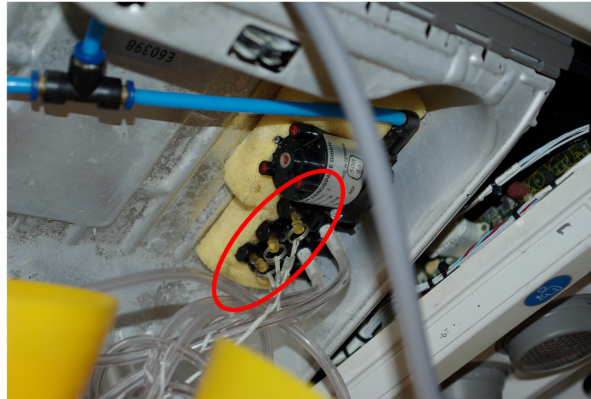

Figure 41: Passenger oxygen container recovered open: the three pins are in place

The oxygen masks were not released: there was no depressurisation in flight.

1.12.2.5. Visual examination of wing and trimmable horizontal stabiliser flight control surfaces

The following parts were found:

- Left wing: part of the inboard aileron, part of the outboard flap trailing edge, parts of spoilers 1 and 6;
- Right wing: part of the outboard flap trailing edge, parts of spoilers 2 and 6;
- Flap track fairings for flaps N°2, 3, 4 and 5 left-hand side, N°2, 3 and 4 right-hand side;
- Parts of the left- and right-hand elevators.

Visual examination of these parts showed deformations and failures resulting from bottom-upwards loads.

Several parts of the flap extension mechanism fairing were found. There were marks on two of them (positioned at the level of flap track N°3), made by the flap extension track on impact. Analysis of these marks (morphological and dimensional examinations) and comparison with an identical aeroplane made it possible to determine that the flaps were in the “retracted” position (see photo below) at the time of impact with the water (measurement of the distance between the track and the lower surface of the flap, position of the carriage on the track).

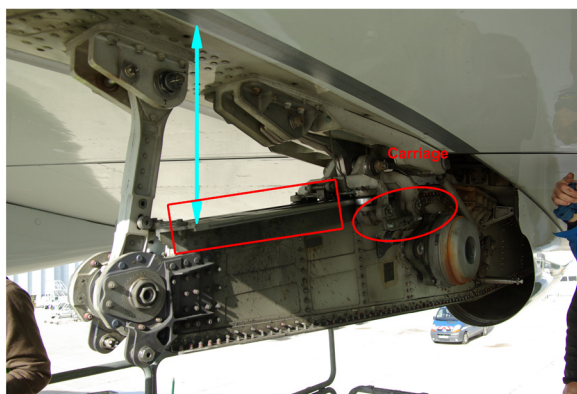

Figure 42: Flap extension mechanism (or flap track) No. 3 in retracted position

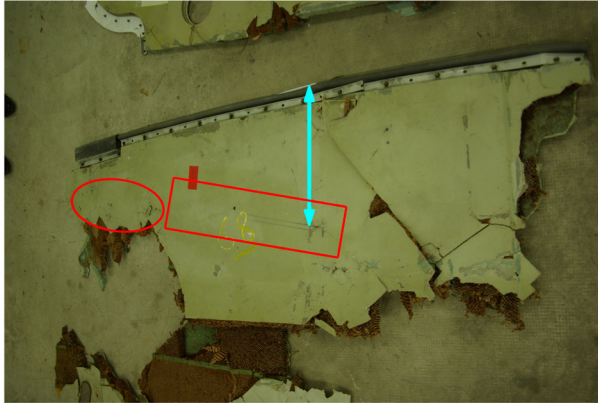

Figure 43: Part of the No. 3 flap track fairing on the left wing

1.12.2.6 Visual examination of the vertical stabiliser

1.12.2.6.1 General examination of the vertical stabiliser

The vertical stabilizer separated from the fuselage at the bottom of the fin, at the three attachments:

- ❑ The forward attachment (male and female lugs) and the lower part of the side panels (lug reinforcements) were missing;
- ❑ The centre and aft attachments were present: male and female lugs and parts of the fuselage frames.

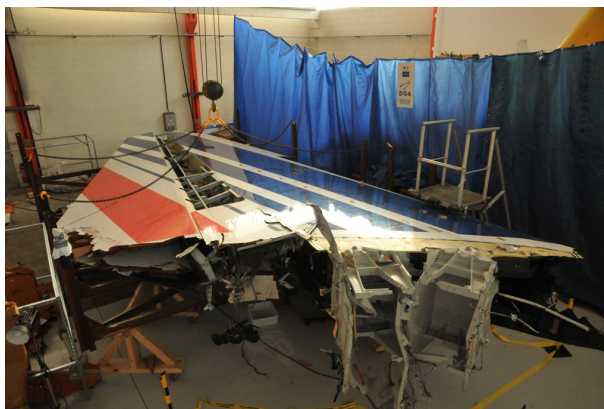

Figure 44: Fin – In the foreground the base of the fin with the central and forward attachment lugs

The front of the fin showed signs of symmetrical compression damage:

- ❑ Failure of the leading edge right- and left-hand panels
- ❑ Longitudinal cracking of the leading edge stiffener
- ❑ HF antenna support (attached to the forward spar): failure of the lower part, crumpling indicating bottom-upwards compression loads.

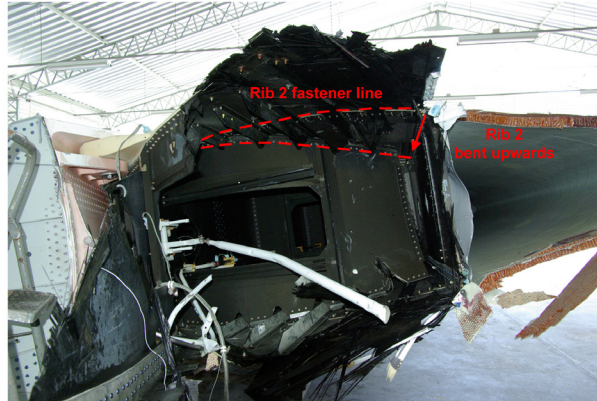

Figure 45: Rib 2 bent upwards as a result of bottom-upwards compression loads



Figure 46: HF antenna support

1.12.2.6.2 Examination of the fin – rudder attachments

The vertical load pick-up arm in the rudder's hinge axis (arm 36G) broke at the level of the attachment lug on the rudder side.

The size of this arm is calculated to withstand a maximum load of 120,000 N, corresponding to a relative acceleration of 36G of the rudder in relation to the vertical stabilizer.

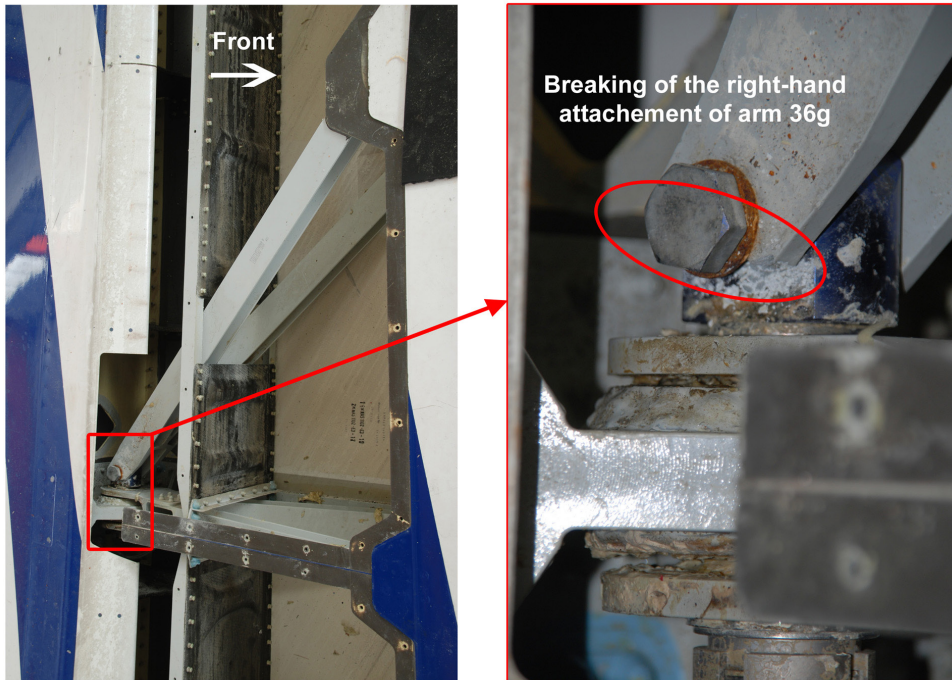

Figure 47: Arm 36G, right view: failure of the rudder attachments

Shear cracks, along a top-down axis, can also be seen on the rudder hinge arm attachment fittings close to arm 36G.

These observations indicate that the vertical stabiliser was subjected to a load greater than 120,000 N in the rudder's hinge axis.

1.12.2.6.3 Examination of the Rudder Travel Limiter Unit (RTLU)

The RTLU was found in its place in the fin and disassembled. An examination was performed at the manufacturer's and showed that it would allow travel of the rudder measured as $7.9^\circ \pm 0.1^\circ$. This value is consistent with the FDR data.

Note: The maximum travel of the rudder is calculated in relation to the aeroplane configuration, its speed and its Mach number. This travel can be commanded between 4 degrees and 35 degrees.

1.12.2.6.4 Examination of the fuselage parts (remains of the skin, frames and web frames)

The fuselage was sheared along the frames and centre and aft attachment lugs by loads applied bottom-upwards.

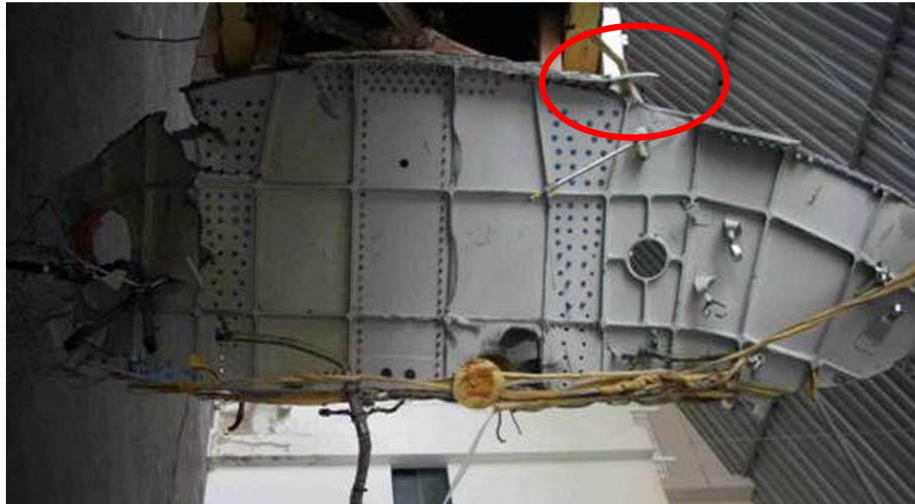

Figure 48: Frame 87: shearing of the frame and fuselage skin along the frame



Figure 49: Right-hand aft lug: shearing of the fuselage along main frames 86-87

The part of frame 87 that can be seen had undergone S-shaped deformation: the left-hand side forwards, and the right-hand side backwards. The horizontal stabiliser actuator supports were deformed and broke in a backwards movement from the front. These observations indicate a backwards movement of the trimmable horizontal stabiliser.



Figure 50: Frames 84 to 87: S-shaped deformation of frame 87, with frames 84 and 85 pushed in backwards;
failure of the horizontal stabiliser actuator supports between frames 86 and 87 (red circle)

Frames 84 and 85 were pushed in backwards in the middle. These deformations likely resulted from the resistance to the forward movement of the aeroplane through water.

1.12.2.6.5 Examination of the fin-to-fuselage attachments

The centre attachment had pivoted backwards with the parts of the frames and web frames that were attached to it. The aft attachment had pivoted forwards with the parts of the frames and web frames that were attached to it.



Figure 51: Fin centre and aft attachments

The aft attachment lugs (male on the fin and female on the airframe) had marks indicating a backwards movement of frames 86 and 87 as a whole.



Figure 52: Rear view of the left-hand aft lug: there were marks showing a backwards pivoting of frames 86 and 87

The centre and aft lateral load pick-up rods showed damage that was consistent with this backwards pivoting of frames 84 to 87:

- ❑ Tensile failure of the centre spar at the level of the centre rod attachments;
- ❑ Compression failure of the aft spar at the level of the aft rod attachments and failure of the left-hand rod by buckling.

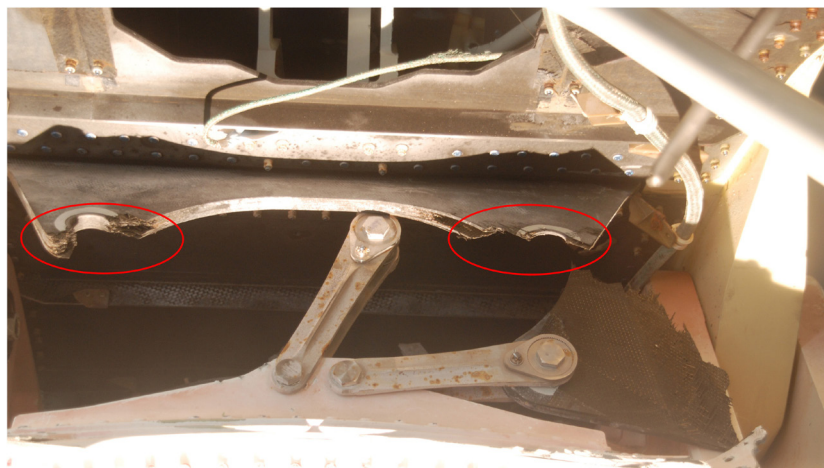

Figure 53: Tensile failure of the centre spar at the level of the attachment of the lateral load pick-up rods

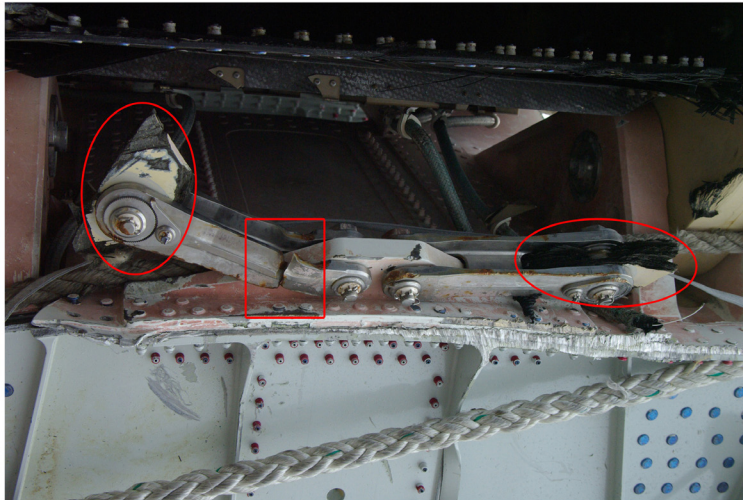

Figure 54: Compression failure of the aft spar at the level of the attachments of the lateral load pick-up rods and failure of the left-hand rod by buckling

1.12.3 Examination of the wreckage

1.12.3.1 The wreckage

The aircraft debris was dispersed over an area around 600 metres long and 200 metres wide and the debris field was roughly oriented 080° / 260°.

The whole wreckage was highly fragmented with some large pieces of debris.

The densest debris (central section, engines, APU, landing gear) was found to the east of the site and the lighter debris to the west.

Outside the main area of 600 metres by 200 metres, a rear left fuselage panel containing eleven windows and around seven metres long was found approximately two kilometres south-west of the area. Part of the lower surface of the trimmable horizontal stabiliser was also found slightly to the south-west of this area.

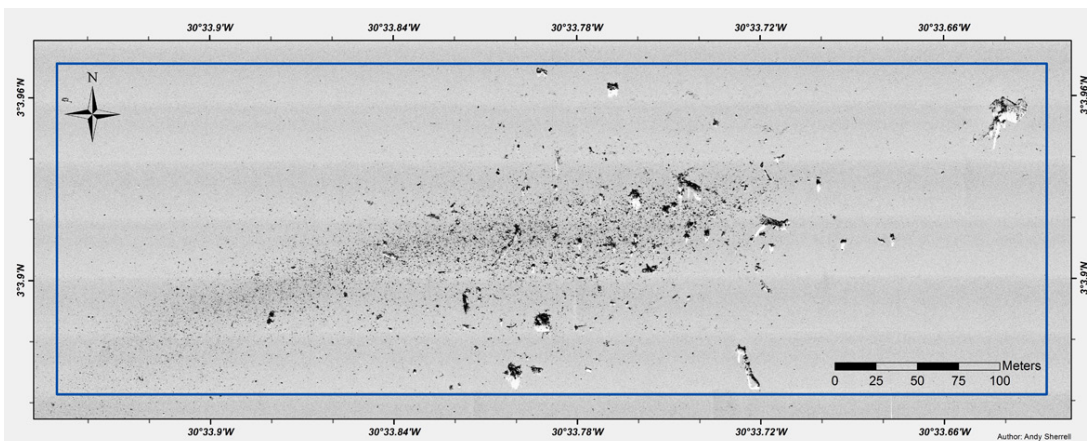

Figure 55: Sonar Images of the debris field

1.12.3.2 Examination of some parts based on underwater video images

The following observations were made on the basis of images supplied by the REMUS and the ROV's.

The lower elements of the fuselage were badly broken up and deformed. In these areas, crushing of the sheet-metal between the ribbing was noted, which indicates a vertical component at the time of impact.

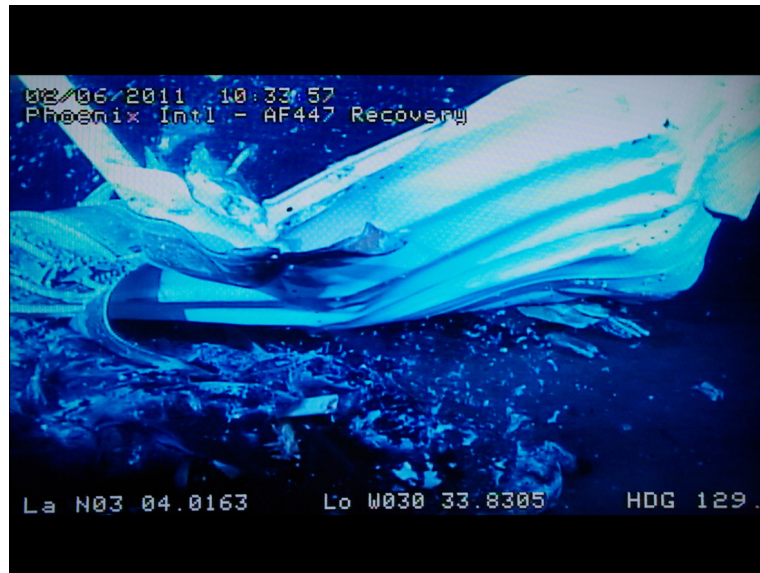

Figure 56: Parts of the fuselage

Both wing boxes had multiple ripped openings. The central wing box, despite its rigidity, was broken up.

The level of debris fragmentation and deformation indicated very high energy on contact with the surface of the water.

The left engine air entry leading edge had significant deformation on its lower part.

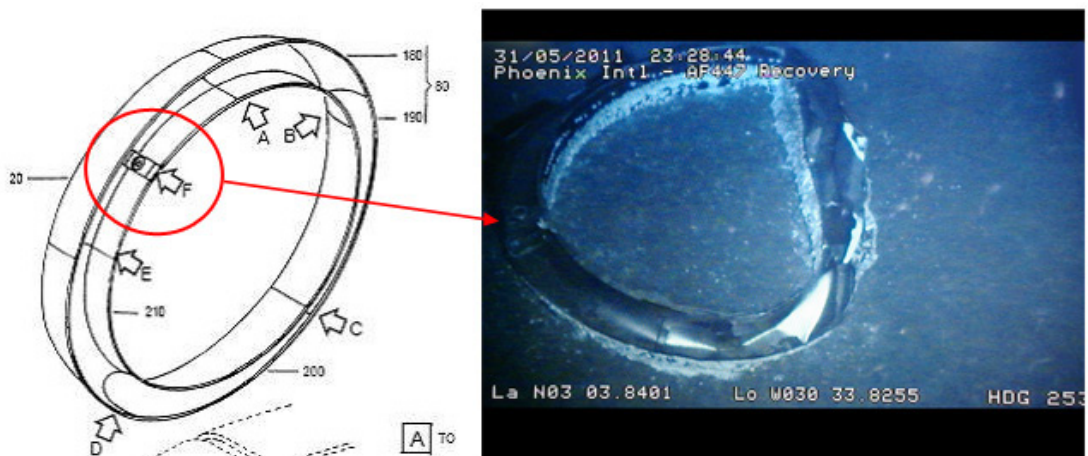

Figure 57: Left engine air intake

The engine pylons were found separated from the wings. They had deformations compatible with loads on the engines from below to above.

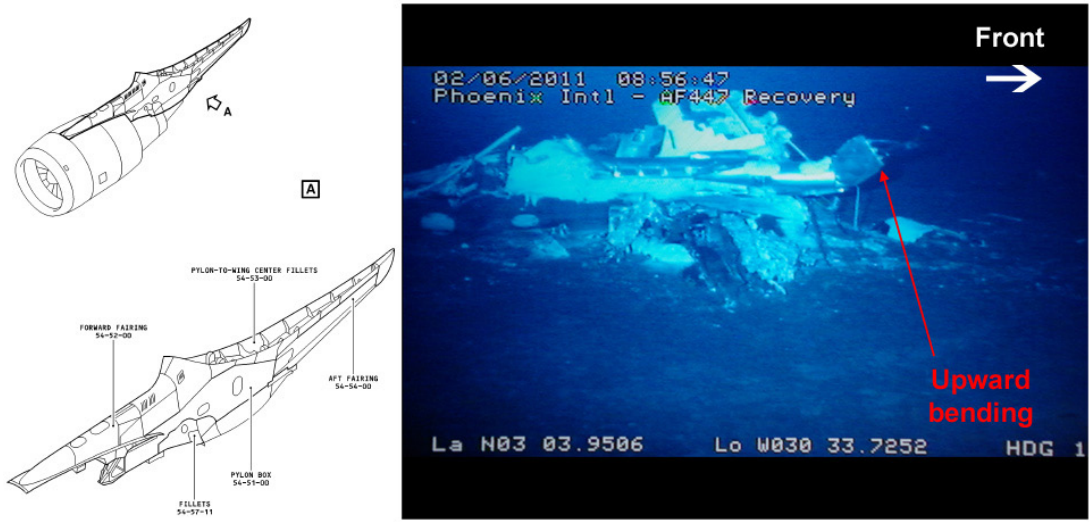

Figure 58: Engine pylon

1.12.3.3 Examination of parts brought to the surface

Some parts were brought to the surface and were subjected to a first visual examination on board the ship.

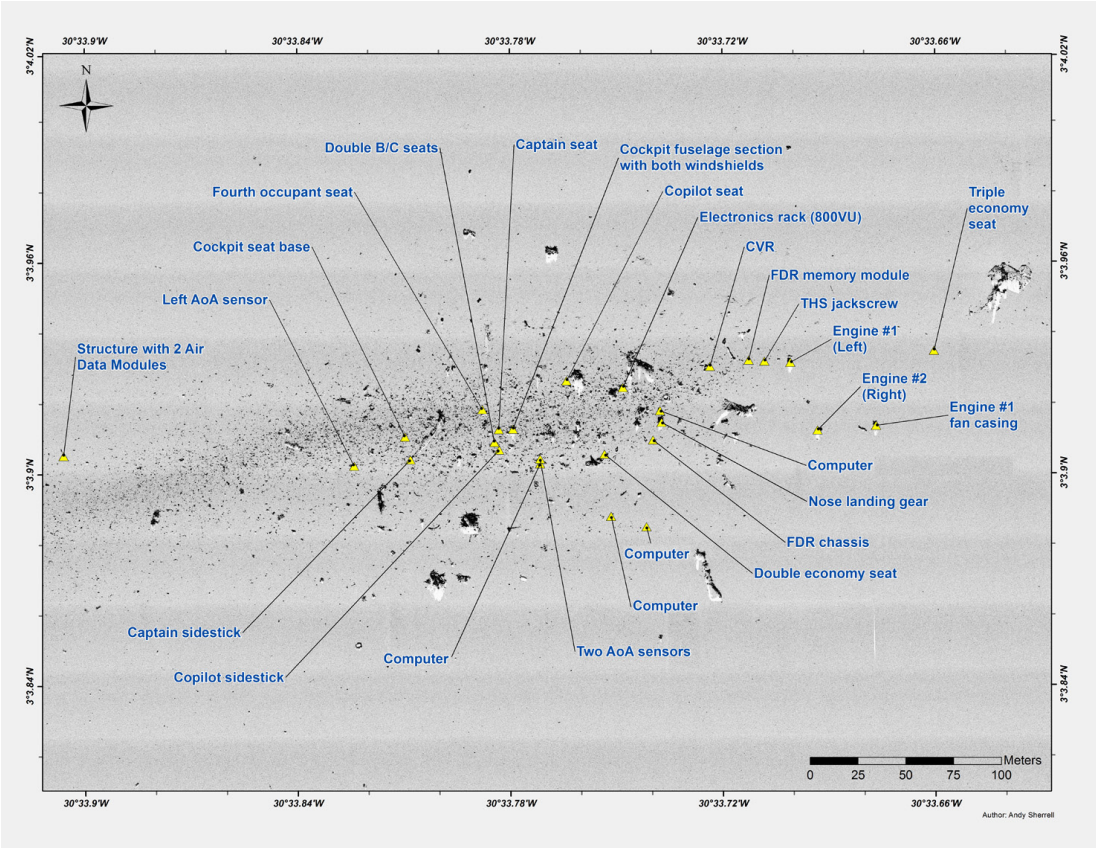

Figure 59: Cartography of the parts subsequently brought to the surface

The visual examination of the two engines showed that they were at high RPM at the moment of impact with the sea.

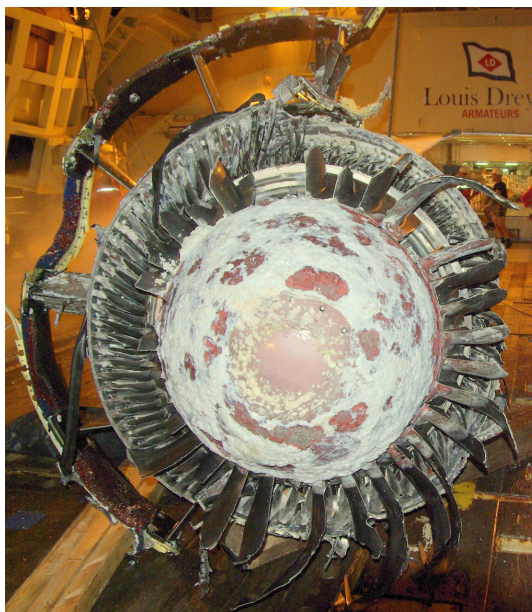

Figure 60: Front view of engine

According to the manufacturer's technical documentation, the relative position of the actuator and the THS screwjack corresponded to a THS position of between 13° and 13.5° nose-up.



Figure 61: Trimmable horizontal stabiliser screwjack after being raised on board

Parts from the recovered cockpit seats were identified:

- Left seat: seat and back with belts,
- Right seat: seat, back with belts, right armrest and seat height adjustment mechanism,
- Jump seat for fourth occupant.

These elements were subjected to a thorough examination. (see §1.16.8).

1.12.4 Summary

The examinations undertaken showed that there was no depressurisation and that on impact:

- ❑ The aeroplane was intact;
- ❑ The aeroplane struck the surface of the water with a pitch-up attitude, a slight bank and a high vertical speed;
- ❑ The flaps were retracted;
- ❑ The engines were at high RPM ;
- ❑ The stabiliser was near to its maximum pitch-up position.

This information was confirmed by the analysis of the data from the flight recorders.

1.13 Medical and Pathological Information

Autopsy reports and photographs of the victims found on the surface of the sea were provided to the BEA by the Brazilian authorities. It should be noted that interpretation of the injuries is disrupted by the effects of prolonged presence in water.

The autopsies performed identified fractures of the spinal column, the thorax and the pelvis. The fractures described were located mainly at the level of the transition vertebrae.

The compression fractures of the spinal column associated with the fractures of the pelvis, observed on passengers seated throughout the cabin, are compatible with the effect, on a seated person, of high acceleration whose component in the axis of the spinal column is oriented upwards through the pelvis.

Examination of the bodies recovered during phase 5 confirmed these observations.

In conclusion, taking into account the vertical acceleration at the time of impact with the surface of the water, there was no possibility of surviving the accident.

1.14 Fire

There was no evidence of fire or explosion.

1.15 Survival Aspects and SAR

The paragraph below describes the data collection operations concerning the Search and Rescue operations (SAR) that would lead to the departure of the first resources deployed for the AF 447 searches.

Between 2 h 47 and 5 h 30, the ATLANTICO, DAKAR Oceanic, SAL and CANARIAS control centres communicated with each other several times and questioned the estimated times of passage of flight AF 447 at reporting points and the fact that none of them had had either radio or radar contact with the aeroplane after 1 h 35. No alert phase had yet been triggered.

During this time, the following actions were taken by the various parties:

At 4 h 18, following the DAKAR controller's request to relay flight AF 447, the crew of flight AF459 sent a message to Air France OCC to try and contact AF 447. The OCC dispatcher sent an ACARS message to the crew of flight AF 447: the message was rejected.

At 4 h 46, the Air France OCC maintenance deputy shift supervisor asked to allow for the possible unavailability of F-GZCP due to severe turbulence in flight.

At 4 h 59, an OCC officer called the DAKAR controller. They both noted their inability to contact the crew of AF 447. The dispatcher stated that the ACARS messages to AF 447 were all rejected.

At 5 h 10, the SAL controller contacted the ATLANTICO controller about flight AF 447. There then followed a discussion that covered in full the reporting points transmitted by the aeroplane, and those estimated by the flight plan (INTOL at 1 h 33 and TASIL at 2 h 20). The SAL controller explained that he had radar and had had no radar contact with AF 447, and that the DAKAR centre had had no contact either. The ATLANTICO controller responded that according to his estimates based on other flights and his calculations, flight AF 447 should be entering the SAL FIR in a few minutes, at 5 h 11. The SAL controller then responded that he would monitor the appearance of a radar return.

Between 5 h 11 and 5 h 26, the OCC shift supervisor tried twelve times to contact the crew of flight AF 447 via SATCOM without success.

At 5 h 17, the OCC maintenance deputy shift supervisor requested information on the meaning of failure messages received at the Hub Maintenance Centre (HMC). The maintenance centre officer indicated that the problems seemed to be located in the Pitot probes. He explained that they had received a number of warnings via ACARS on the flight controls. The HMC officer said he knew of similar cases involving aeroplanes passing through storms. The HMC officer also stated that there was no message relating to a failure of the communication system.

At 5 h 23, the ATLANTICO controller informed his ARCC associate about the uncertainty of the position of flight AF 447. The ARCC triggered the SAR process, consisting initially of gathering all the data concerning flight AF 447 (take-off confirmation, flight plan, autonomy, radar trajectory among others) from several organisations.

Many telephone contacts were made between the various control centres, the OCC and the ARCC's involved. Details of these communications are in appendix 4.

The following is of note:

- At 5 h 23, ATLANTICO-RECIFE ARCC registered the disappearance of the AF 447 and triggered the SAR process which consisted initially of gathering information;
- At around 8 h 00, the Air France OCC set up a crisis group.;
- At 8 h 22, the Madrid centre sent the alerfa-incerfa message to the ATLANTICO, DAKAR, SAL, CANARIAS, CASABLANCA and BREST centres;
- At 9 h 09, the BREST centre issued a detresfa message;
- At 9 h 31, the SAL control centre sent an alerfa-incerfa message;
- At 11 h 04, the first Brazilian aeroplane took off for SAR operations;
- At 11 h 07, it was announced that flight AF 447 was at the limit of its fuel autonomy;
- At 12 h 04, the ATLANTICO-RECIFE ARCC defined a first position for the searches (from SALPU);

- ❑ At 12 h 14, the Bréguet Atlantique 2 took off from DAKAR and was put at the disposal of the Brazilian authorities;
- ❑ At 13 h 00, the ATLANTICO-RECIFE ARCC obtained the last coordinates transmitted by AF 447 from the Air France crisis group;
- ❑ At 13 h 59, the intervention by the Gris Nez MRCC enabled confirmation of the Natal MRCC as coordinating body for the search and rescue resources.

From the last conversations between the aeroplane and the ground, it took more than 3 h 30 min before the SAR process was put into effect, more than 6 h 30 min to launch the INCERFA and ALERFA phases and over 9 hours to send the first search aircraft.

1.16 Tests and Research

1.16.1 Underwater search and recovery operations

The BEA was mandated after the end of the search and rescue operations (SAR) with the organisation and coordination of operations carried out by France for the search and recovery of the wreckage. Given the distance from the accident and the topography of the sea bed, this particular mission required the considerable mobilisation of air, naval and underwater forces and, even more so, of multidisciplinary skills (safety investigators, scientists, the army, underwater search experts, etc).

The wreckage of the Rio-Paris flight aeroplane was found on 2 April 2011, 22 months after disappearing. A special document on the four sea search phases and on the recovery phase will be the subject of a separated publication.

1.16.1.1 Summary of Phases 1 to 4

The first search phase aimed at detecting and locating the acoustic signals transmitted by the Underwater Locator Beacon (ULB) fitted on each flight recorder⁽⁸⁾. As a priority, the aeroplane's planned flight path as well as the greatest possible area inside the 40 NM circle was swept by two Towed Pinger Locators (TPL)⁽⁹⁾.

No signal from either of the beacons was detected by the sensors deployed in the area despite TPL passing by, on two occasions, not far from the debris field, on 22 and 23 June 2009.

Sonar imaging systems with the ability to recognise components on the sea bed were deployed during the phases that followed.

- ❑ Phase 2 was carried out from 27 July to 17 August 2009 with the help of the IFREMER deep tow system, called SAR, over an area of about 1,100 km². This search was unsuccessful but nevertheless enabled the BEA to carry out a complete bathymetric survey of the 40 NM circle. This very precise reading of the underwater profile carried out by the multi-beam echo sounder mounted on the hull of the research vessel the Pourquoi Pas? enabled the BEA to ensure the subsequent safe and efficient deployment of the autonomous and towed resources.
- ❑ Phase 3 was organised around two on-site search periods: one from 2 to 25 April 2010, and the second from 3 to 24 May 2010. The ORION deep tow sonar and the three REMUS⁽¹⁰⁾ 6000 autonomous underwater vehicles (AUV) operated by the Wood Hole Oceanographic Institution (WHOI) explored an area of nearly 6,300 km². This search also proved unsuccessful.

⁽⁸⁾There were two beacons on the A-330, one attached to the cockpit voice recorder (CVR) and the other to the flight data recorder (FDR).

⁽⁹⁾The two US Navy TPL's are the only two towed hydrophones in the world able to operate to a depth of up to 6,000 metres.

⁽¹⁰⁾Two AUV REMUS 6000 belonging to the Waitt Institute for Discovery (WID), and one belonging to the German oceanographic institute IFM GEOMAR.

The lack of success during the first three search phases led the BEA to undertake a complete review of both the means used and the zones explored. Drawing on all the elements provided by various partners in the searches (scientific institutes, statistical analysts, oceanographers, etc), and comparing them with the result of the previous phases, the BEA decided to redirect its search strategy by leading a final systematic search operation in all the areas not explored during phases 2 and phase 3, beginning within a circle of 20 NM from the last known position.

The Phase 4 operations took place from 25 March to 9 April 2011. The REMUS 6000 AUVs were used again in the search during this phase. They were operated by WHOI from the Alucia, property of Deep Ocean Expeditions.

Discovery of the accident site

On 2 April 2011, the data from the 18th AUV mission was recovered, and analysis of the sonar images brought to light a concentration of backscattered parts on the sea bed distributed over a rectangular area of about 600 by 200 metres.

A mission to identify the type of components by photographs was immediately scheduled. This mission ended on 3 April 2011 and the photos taken confirmed that the detection from the sonar images corresponded to aeroplane components. Over the following days additional AUV missions were conducted to determine the scope of the wreckage field, and obtain a complete photographic record of the primary wreckage area.

1.16.1.2 Organisation of Phase 5 operations

Phase 5 was organised in two stages. The first, which took place on-site from 26 April to 13 May 2011, involved the search for and recovery of the flight recorders and aeroplane parts. The second took place from 21 May to 3 June 2011 with the aim of underwater observation of the whole wreckage, mapping the debris and finally the recovery of human remains.

All these operations were carried out from the Ile de Sein cable vessel operated by Alcatel Lucent and Louis Dreyfus Armateurs, using Phoenix International's REMORA III autonomous underwater vehicle.

Discovery and recovery of the flight recorders

On 1st May 2011, the investigation team located and identified the protected module of the flight data recorder (FDR). The latter was raised and lifted on board the Ile de Sein by the ROV REMORA 6000 the same day. The following day the CVR was located and identified. It was raised and lifted on board the Ile de Sein on 3 May 2011. The flight recorders were first transferred to the port of Cayenne (French Guyana) by the French navy patrol boat *La Capricieuse*, then transported to the BEA by air on 12 May 2011. The recovery of aeroplane parts continued during that period, with in particular the engines and the avionics bay containing onboard computers being raised.

The underwater search and recovery operation for the wreckage of the F-GZCP ended on 16 June 2011, the date the aeroplane parts arrived at the port of Bayonne.

1.16.2 Study of unreliable indicated airspeed events (temporary loss or anomalies) occurring in cruise on Airbus A330/A340

The BEA has studied thirteen unreliable indicated airspeed events involving the temporary loss of this reading, or other anomalies, for which it had access to crew reports, recorded parameters and PFR. The following operators have made this data available to the BEA:

- Air France (4 cases);
- TAM (2 cases);
- Qatar Airways (4 cases);
- Northwest (1 case);
- Air Caraïbes Atlantique (2 cases).

Several other known events were not studied due to the absence of sufficient information. The BEA also interviewed some of the crews involved in these flights.

The analysis was limited, particularly because some relevant parameters were not recorded. For example, the three CAS and the three angles of attack were not all recorded (one as a minimum, sometimes two). The audible stall warning and the position of the probe/window heat push-button were not always recorded.

This study identified a number of significant points in terms of the environment, automated systems and flight path control.

➤ **With regard to the environment, it is notable that:**

- The flights levels were between FL 340 and FL 390;
- The air masses were highly unstable and characterised by powerful convection phenomena;
- The static temperature was less than - 40°C in twelve cases. In ten cases, it exceeded by between 0°C and 6°C the temperature in standard atmosphere; in the three other cases it was higher than STD+10°C;
- Crews reported that they had not observed significant radar returns for their selected flight path but had identified active zones nearby or at lower altitude; this was also a finding of a study by Météo France (national meteorological office) into these events, conducted at the request of the BEA;
- Three crews reported having heard or observed what they identified as rain or ice;
- All the events occurred in IMC;
- The recordings of the total or static temperatures reveal increases of ten to twenty degrees during the event, in some cases with the increase starting before the airspeed anomalies were observed, except in one case where the increase was smaller;
- Turbulence was always recorded and reported. The levels felt by the crews varied from light to strong. The range of normal acceleration values recorded varied from [0.75/1.2g] to [0.2/1.9g].

➤ **Concerning automatic control and systems, the following points are of note:**

- The aircraft's autopilot disconnected in all cases, with no intervention from the crew;
- In all cases, the crew regained the use of the autopilot and autothrust;
- In twelve cases, the flight control law changed to alternate until the end of the flight. In one case, this transition was temporary;

- ❑ The disconnection of the autopilot was accompanied by the disappearance of the associated flight director, and sometimes by the other flight director for a variable period of time. In all the cases studied, the flight directors reappeared during the event. In certain cases, this reappearance was recorded simultaneously with a return to values very close to the two speeds;
- ❑ In seven cases, an autopilot was re-engaged during the event. In two of these, the re-engagement occurred even though two speeds were consistent with each other, but erroneous;
- ❑ The autothrust disconnected in ten cases, leading to the activation of the thrust lock function. In five of these cases, this function remained engaged for more than one minute;
- ❑ In one case, the crew had disconnected the autothrust and commanded the thrust corresponding to the speed recommended for turbulent atmosphere before the event;
- ❑ In two cases, the autothrust did not disconnect and the flight directors did not disappear. The recordings of engine RPM parameters reveal fluctuations in thrust with N1 values of between 48% and 100%.

➤ **Concerning speed anomalies:**

- ❑ They can be characterized by two distinct signatures:
 - Intermittent drops (spikes),
 - A drop followed by levelling off (continuous period);
- ❑ These speed anomalies were accompanied by an instantaneous increase in indicated static temperature (and in total temperature, when it was recorded), and a “fall” in indicated altitude, particularly on the A330-200 (see paragraph 1.6.9.6). In both cases, the lowest speeds recorded were less than 100 knots.
- ❑ The maximum recorded duration of continuous invalidity of indicated speed was three minutes and twenty seconds.
- ❑ When the speed values calculated by the ISIS were recorded, the signatures and/or durations of their anomalous values show differences from those noted on the recording of the speed displayed on the Captain’s side.

➤ **With regard to the crews’ reactions, the following points are notable:**

- ❑ The variations in altitude were contained within about one thousand feet. There were five cases of deliberate descent, including one of 3,500 feet. These descents followed a stall warning;
- ❑ Four crews did not identify the unreliable airspeed situation: in two cases, the crews concluded that there was an inconsistency between the angles of attack; in the two other cases, the crew considered that the speeds were erroneous rather than unreliable.

For the cases studied, the recorded flight parameters and the accounts given by the crews did not reveal any application of the memory items from the unreliable airspeed procedure, nor the procedure itself:

- ❑ The reappearance of the indications of flight directors on the PFD suggests that no disconnection inputs were made into the FCU;
- ❑ The durations of engagement of the thrust lock function indicate that no attempt was made to rapidly disconnect the autothrust followed by a manual adjustment of the thrust to the recommended value;
- ❑ There was no attempt to command display a pitch attitude of 5°.

Important points revealed by analysis of these 13 unreliable IAS.

In the cases studied:

- ❑ The aeroplanes remained within the flight envelope during these relatively short events;
- ❑ The FD's did not disengage;
- ❑ The autothrust had been disconnected before the anomalies began in one case. In the other cases, either the autothrust remained engaged, or the thrust lock function remained active for several dozen seconds before the manual adjustment of the thrust.

Reactions of the crews

This type of anomaly resulted, in most cases, in the AP disconnecting, the FD disappearing, the autothrust changing to thrust lock and the flight control law changing to alternate.

The pilot flying prioritised flying tasks and the aircraft's flight path, maintaining a cruise attitude or descending to increase the margins for manoeuvre within the flight envelope. The decision to descend may also have been decided as a result of the stall warning triggering.

The reappearance of the flight directors on the PFD when two airspeeds are calculated as similar may prompt the crew to promptly engage an autopilot. However, although the magnitude of these speeds may be the same, they may be erroneous and low, and could cause the autopilot to command flight control surface movements that are incompatible with the aircraft's actual speed.

In those cases where the autothrust is automatically disconnected and the thrust lock function activated, the absence of an appropriate manual adjustment of the thrust may generate a risk of the combination of the pitch attitude and thrust being unsuitable, notably when this disconnection occurs when the N1 value is low.

Stall warning

Nine cases of the activation of the stall warning were noted.

The stall warning activates when the angle of incidence exceeds a variable threshold value. All the warning activations can be explained by the fact that the aircraft was in alternate law at cruise Mach and in turbulent zones (see also paragraph 1.6.11). Only one warning triggering event was caused by a distinct input on the controls.

Case of TAM flight on 12 November 2003

This case, which happened to an A330-200, was not one of the thirteen events studied above because no crew report was available. However, in the light of the data from flight AF 447, it seems useful to mention it. In fact, following icing of at least two Pitot probes at FL360, the crew made some high amplitude flight control inputs (to the stop), sometimes simultaneously. When the AP disengaged, both pilots made pitch-up inputs (one went to the stop) that resulted in an increase in pitch of 8°. On several occasions, the stall warning was triggered due to the nose-up inputs, and the crew reacted with strong pitch-down inputs. During the 4 minutes that the sequence lasted, the load factor varied between 1.96 g and -0.26 g, the pitch attitude reached 13° nose-up and the angle of attack reached 10°. Altitude variations, however, were less than 600 ft.

1.16.3 Analysis of functioning of systems

1.16.3.1 Analysis of the initial sequence

Analysis of the FDR parameters and of the data contained in the two FMGECs' non-volatile memories showed that:

- ❑ The ADR 2 speed fell between 2 h 10 min 03.5 et 2 h 10 min 05;
- ❑ the ADR 1 speed fell for less than one second from 2 h 10 min 04 s to 2 h 10 min 05, causing:
 - the disconnection of the autopilot,
 - the triggering of "PITOT PROBE" monitoring in the FCPC causing the transition to alternate 2B law;
- ❑ The ADR 3 speed fell temporarily from 2 h 10 min 07 s to 2 h 10 min 10 s, causing, in the following second, the loss of autothrust and the disappearance of the Flight Directors; it then fell again at 2 h 10 min 14,
- ❑ The speed on ADR 1 fell again at about 2 h 10 min 08 s, causing the loss of the autothrust and of the flight directors within the next second.

At 2 h 10 min 05, the loss of FD 2 recorded on the FDR corresponds to the loss of this function in the FMGEC 2 as a result of the rejection of ADR 1 and 2 by this computer. However, this does not correspond to a loss of the FD display on the right side PFD. In fact, when the computation by the flight director is unavailable in FMGEC 2, the orders computed by FMGEC 1 are displayed on the right side PFD.

1.16.3.2 Analysis of the operation of the stall warning

From 2 h 10 min 05 onwards, the flight control law was alternate and the stall warning triggered and stopped several times until the end of the flight. Only the values for one Mach calculation were recorded, although the warning triggering threshold depends on all three (refer to the description of the operation of this warning in section 1.6.11).

From 2 h 10 to 2 h 11

The graph below shows the change in the three recorded angles of attack as a function of time, in addition to the theoretical threshold at which the stall warning was triggered. This threshold was determined from a Mach value that was itself calculated from ground speed, wind and static temperature parameters. Comparison of this calculated Mach with the recorded Mach shows a good correlation.

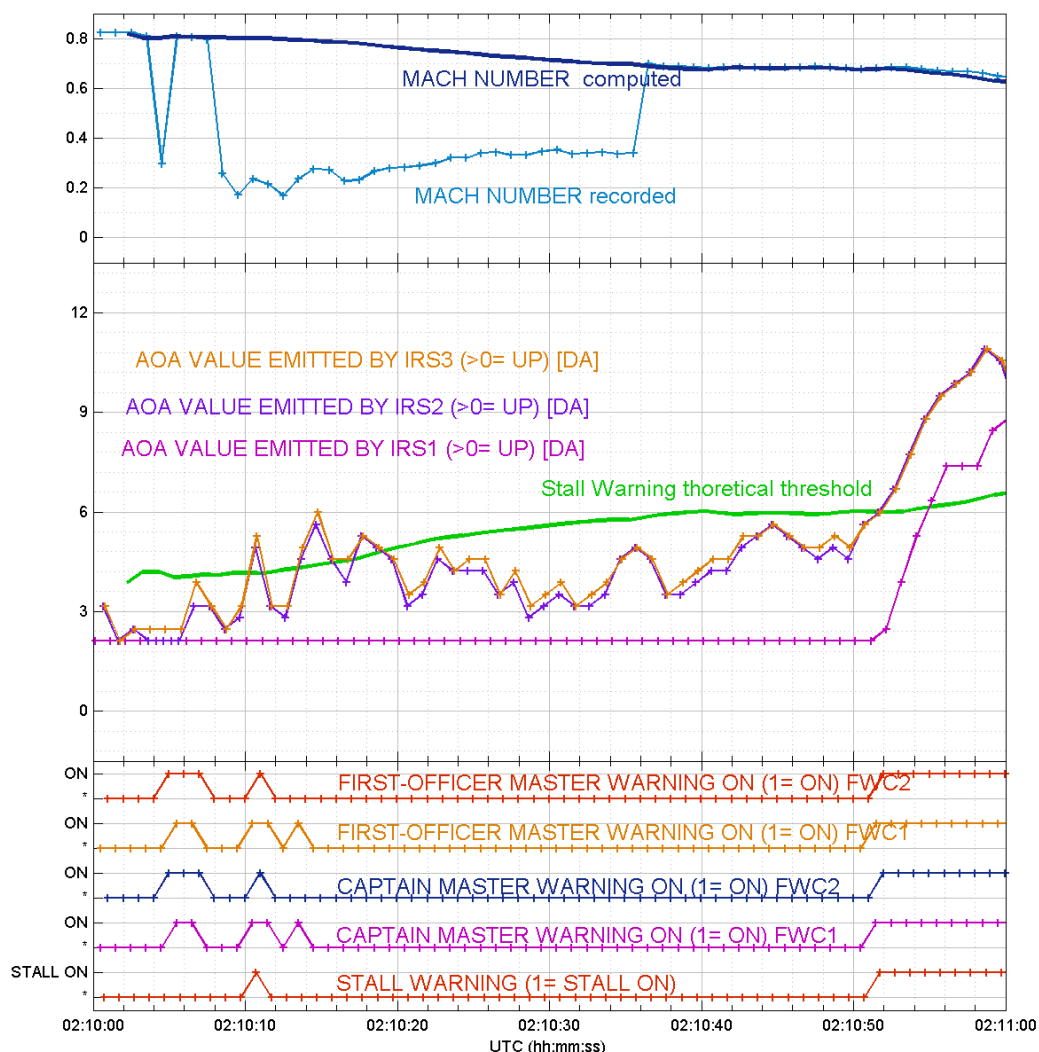

Figure 62: Evolutions of recorded angles of attack and of the stall warning trigger threshold

The activations of the warning picked up by the CVR were identified as occurring at between 2 h 10 min 10.4 and 11.3 and between 2 h 10 min 13 and 13.4. The short duration of activation did not make it possible to detect it from the "Stall warning" parameter, but the FWC 1's "Master warning" parameters were triggered on one point at this time. However, this warning should have continued until about 2 h 10 min 15.5, and then have been triggered again between 2 h 10 min 17 and 19. The disabling of this warning was probably due to the fact that, between 13.4 and 15.5 and then between 17 and 19, and possibly at other times, the three Mach values were abnormally low (three Pitot probes iced up). The warning triggering threshold then suddenly increased to values of about 10°, much greater than the recorded angles of attack, which led to the warning stopping.

After 2 h 11

Analysis of the parameters showed that the stall warning stopped concomitant with the invalidity of the three angles of attack, and was triggered again when at least one of them became valid again. In view of the extreme values of angle of attack experienced by the aircraft, the change to the threshold as a function of Mach was secondary.

The stall warning triggered again ten times after 2 h 11 min 45; a correlation was noted between this triggering and a pitch-up input by the PF on two occasions, between 2 h 12 min 52 and 2 h 12 min 57 then between 2 h 13 min 52 and 2 h 14 min 02.

Note: the behaviour of the angle of attack 1 was slightly different from that of the two others (“lazy” behaviour) . Though the cause of this difference could not be established, it had no effect on the functioning of the systems.

1.16.3.3 Analysis of the flight control law

The flight control law changed from normal to alternate at about 2 h 10 min 05. The alternate law was 2B and it did not change again thereafter. Due to the rejection of the three ADR by the flight control computers (PRIM), the abnormal attitudes law could only have been triggered for criteria relating to inertial parameters, but these conditions were never met.

A simulation of the operation of the flight control computers was undertaken, which involved recalculating the movements of the elevators and of the trimmable horizontal stabiliser (THS) based on pilots’ inputs and compared the results against FDR parameters. This simulation was continued up until the end of the flight. The recalculated deflection angles for the elevators and the PHR are consistent with the parameters recorded.

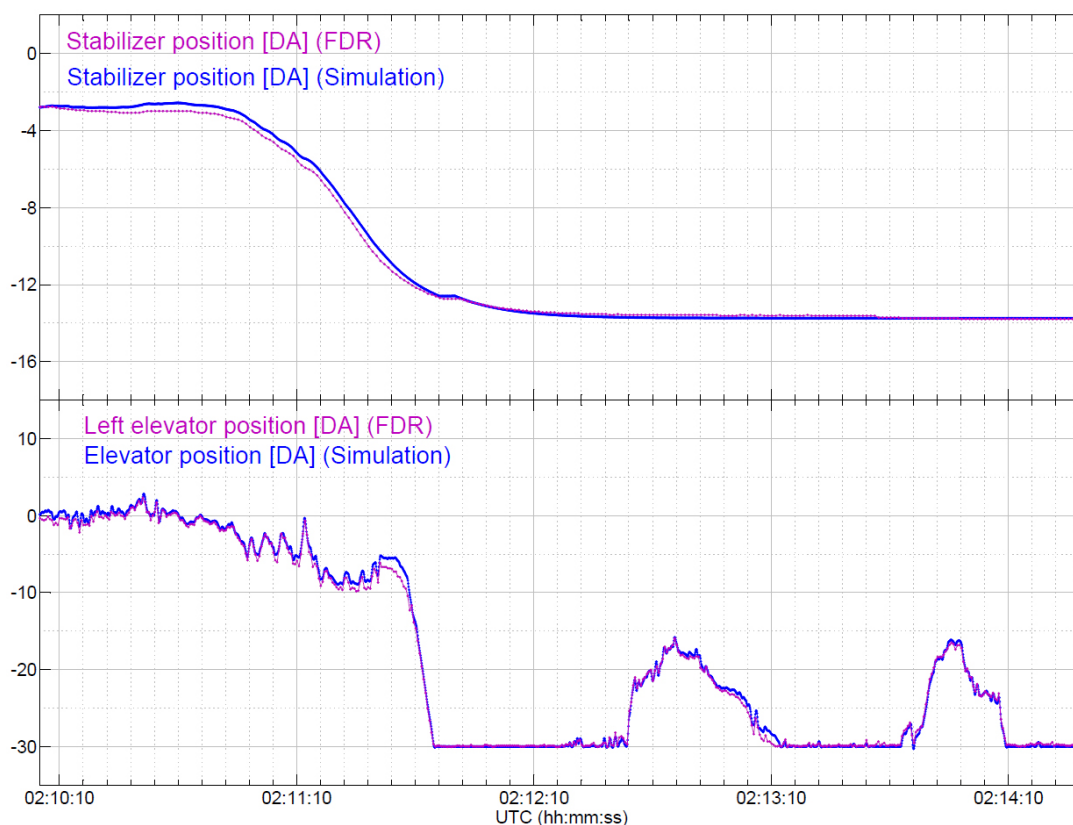

Figure 63: Comparison between the recorded positions of the elevator and THS and the simulation

1.16.4 Analysis of aircraft performance

1.16.4.1 Aircraft behaviour

A simulation of the aircraft behaviour was conducted based on the theoretical model and on the PF’s inputs (sidestick and thrust). The validity of the model is limited to the known flight envelope based on flight tests. Consequently, it was possible to conduct the simulation on the period from 2 h 10 min 00 s to 2 h 10 min 54 s.

Prior to the disconnection of the autopilot, a constant headwind component of 15 kt had to be added in order to make the simulation's ground speed match the recorded parameter. This value was consistent with the wind parameters recorded. The turbulence was modelled by introducing gusts so that the simulated parameters were copied from the parameters recorded.

The simulation demonstrated the following:

- ❑ From about 15 seconds before disconnection, the autopilot countered aerological disturbances whose intensity would be defined as "light" on the ICAO scale (variations in vertical acceleration of less than 0.5 g);
- ❑ When the autopilot disengaged, a concomitant lateral gust caused the aircraft to depart from its flight path with a roll to the right;
- ❑ The subsequent roll movements resulted from the inputs by the PF;
- ❑ The aircraft's movements in the longitudinal axis were primarily due to the inputs by the PF, with the exception of small variations due to the aerology (variations in normal acceleration of about 0.2 g);
- ❑ The turbulence eased as from about 2 h 10 min 30 s;
- ❑ With no PF inputs, the aircraft would have gradually rolled further to the left but the variations in pitch attitude and altitude would have been small.

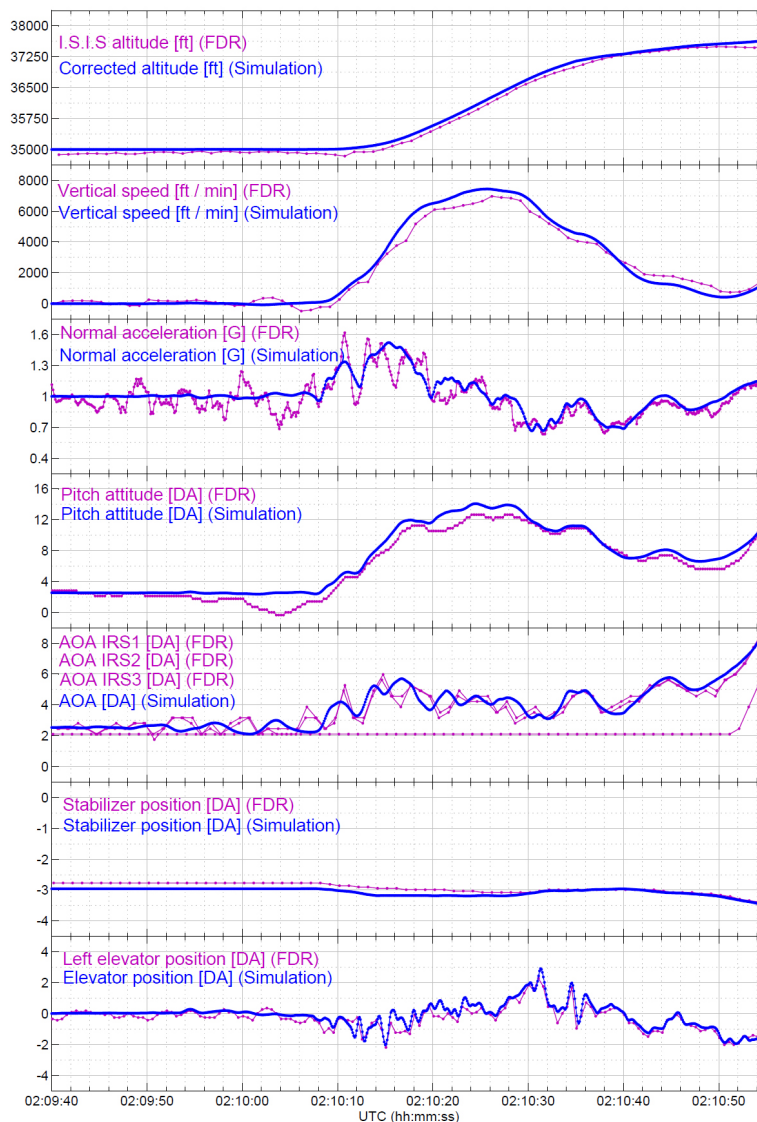

Figure 64: Comparison between altitudes of the aeroplane and the simulation (longitudinal axis)

1.16.4.2 Analysis of the exit from the flight envelope

At the time of the event, the flight envelope of the aeroplane was as follows:

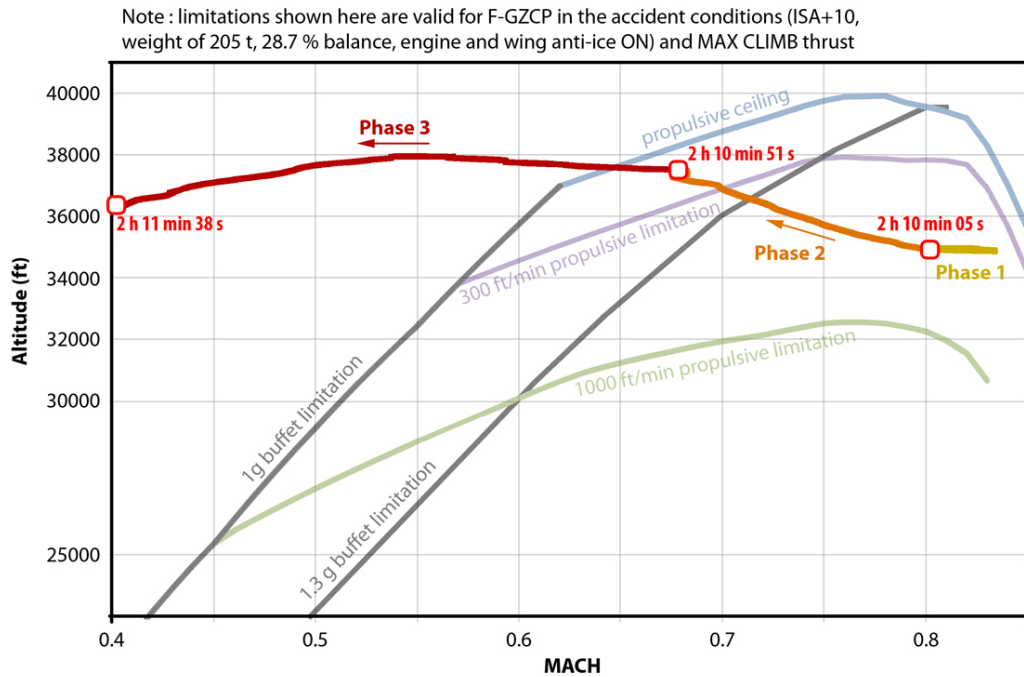

Figure 65: Flight envelope

At 2 h 10 min 51, when the aircraft was at about 37,500 ft and still climbing, the stall warning was triggered (see 1.16.3.2). A change in the recorded normal acceleration behaviour was demonstrated from 2 h 10 min 53, at an angle of attack about 1 to 2 degrees greater than the warning activation threshold.

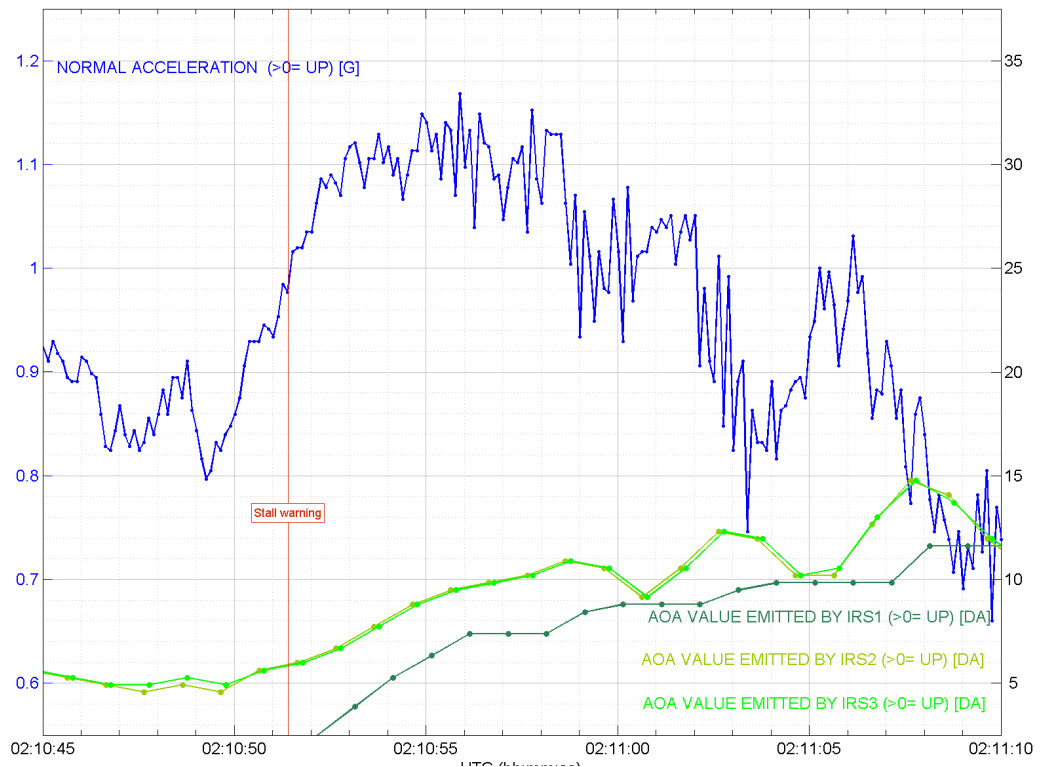

Figure 66: Evolution of normal acceleration recorded at the time of activation of the stall warning

This modification of the behaviour resulted in the appearance of a high frequency component of an amplitude increasing to up to about 0.1 g peak-to-peak, and with a signature that is very different from a turbulence signature of aerological origin. Furthermore, there is a noise on track 1 of the CVR, at about 2 h 10 min 55, which may be the impact of the microphone striking a panel, heard at a stable frequency.

Note: According to the simulation of the aircraft movements, at this time the turbulence observed in the first seconds of climb had stopped.

Additional analyses were conducted with Airbus to determine if this phenomenon could correspond to buffet. The identification of this phenomenon is complicated by the fact that the concept of buffet is defined as accelerations at the level of the pilots' seats and not at the centre of gravity.

Airbus subsequently flew special flights to collect more accurate data at high angles of attack and with an aircraft configuration close to that of the accident (mass, flight level, Mach, etc.). These tests made it possible to refine the preliminary correlations and to establish that the level of buffet was considered to be a deterrent by the test pilots when the angle of attack was about 10°, corresponding to normal acceleration amplitude of 1 g at the pilot's seat. This angle of attack was reached at about 2 h 10 min 57 s during the accident flight.

Thus, the stall warning was triggered at 2 h 10 min 51 at an angle of attack corresponding to the theoretical threshold for the measured Mach value. Two seconds later, vibrations that might correspond to buffet appeared. The intensity of vibration probably reached the deterrent buffet level at about 2 h 10 min 57 s.

1.16.5 Reconstruction of the information available to the crew

1.16.5.1 Analysis of the airspeed displayed on the PFD's and ISIS

Analysis of the FDR data made it possible to determine, for each PFD, the time periods when the CAS was displayed as well as the corresponding ADR source.

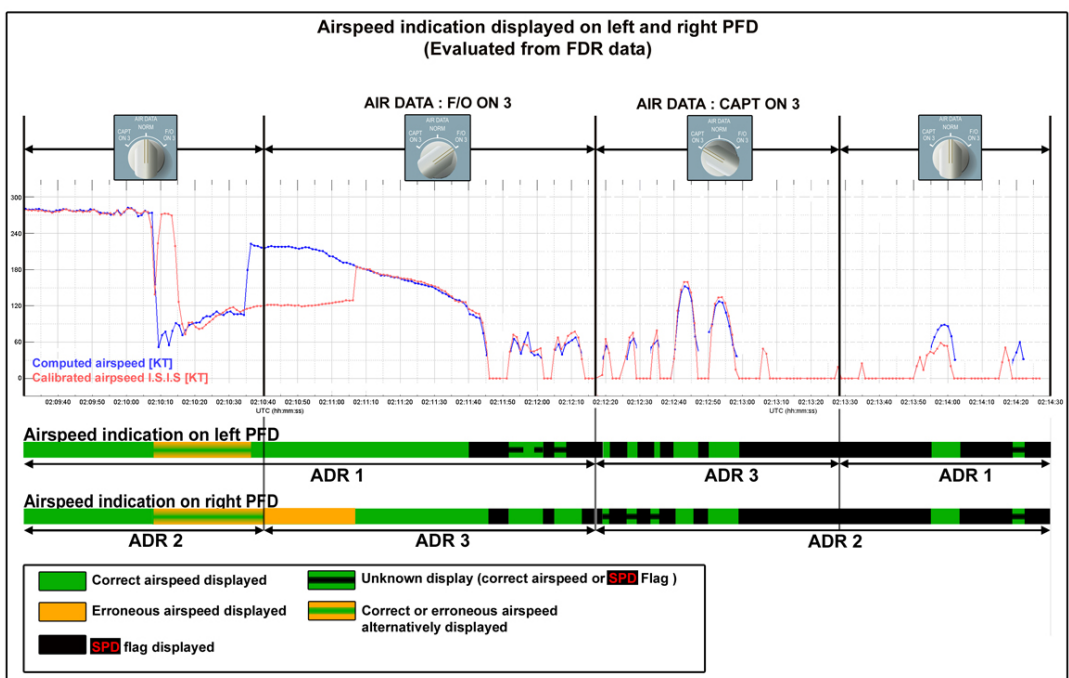

Figure 67: Speed displays on the PFD

1.16.5.2 Evolution of CAS 2

Knowledge of CAS 2 is required to:

- Know the speed displayed on the right PFD when the AIR DATA selector is not positioned on "F/O ON 3";
- Calculate the position of the FD displayed on both PFD's;
- Calculate the speed trend displayed on both PFD's.

Analysis of the data from the FMGEC, the ACARS messages and the FDR made it possible to partially determine the evolution of the CAS 2 during the flight.

Thus, it was possible to establish that the Pitot probe on the copilot's side (F/O Pitot):

- started to freeze at the earliest at 2 h 10 min 03.5 and at the latest at 2 h 10 min 05. The CAS 2 was then more or less equal to CAS 1 and thus equal to the airspeed recorded by the FDR;
- unfroze definitively at 2 h 10 min 46 at the latest. The CAS 2 was then more or less the same as CAS 1.

Between these two moments, the Pitot probe on the copilot's side certainly unfroze, at least temporarily.

Two icing profiles were established, one in which the Pitot probe remained frozen for the longest period of time and the other for the shortest period of time. It was not possible to determine which of the two profiles was more likely. Consequently, the evolution of the CAS displayed on the right PFD is partially known for the period from 2 h 10 min 3.5 to 2 h 10 min 46, as the following graph illustrates.

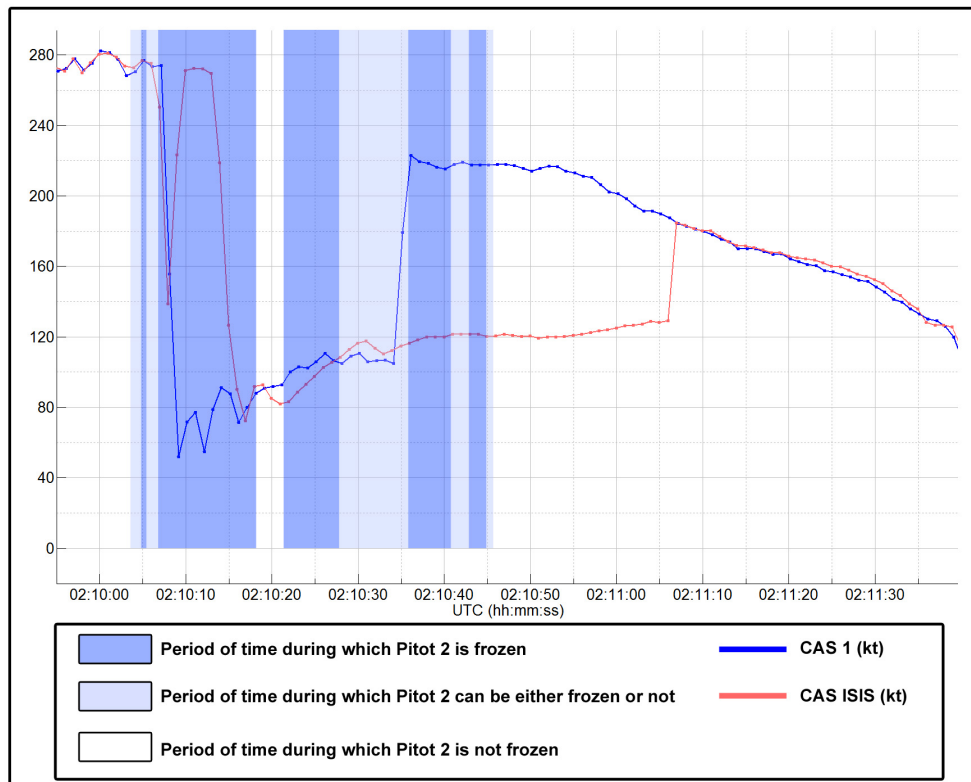

Figure 68: Evolution of the 3 CAS

1.16.5.3 Calculation of the speed trend

The speed trend arrow represents an estimation of the acceleration of the aeroplane: the tip of the arrow indicates the airspeed that the aeroplane will be at 10 seconds later. Its value depends on the earlier evolution of the speed used for the calculation.

In order to be free of this evolution in relation to CAS 2, the determination of the speed trend displayed by the right PFD was made from 2 h 10 min 46. In addition, from that moment, the CAS 1 and 2 can be considered as identical and valid. Some differences can exist between the speed trends displayed on the left and on the right at the time of the unfreezing of the CAS,2 due to the calculation mode (filtering). However, the sudden increase in the CAS 2 in any case caused a transitory phenomenon increasing the value of the speed trend for several seconds. It thus appeared that the speed trend indicated an acceleration that could be significant in the moments around the triggering of the stall warning. Subsequently, the speed trend indicated a deceleration up until the end of the period of recalculation at 2 h 11 min 40.

1.16.5.4 Calculation of the flight director orders

The flight director orders were recalculated over all the time periods considered relevant. Depending on the engagement modes (identical right and left), the orders given by the right and left crossbars may have been different. In this case, it was established that orders presented on the right and left were either identical or extremely close. Given the engaged modes and the operation of these modes, and despite only partial knowledge of the development of CAS 2, it was possible to mark the position of the longitudinal DV. The accuracy is relatively good over certain time periods (min. and max. close), less good over a particular time period (knowledge of the max position only between 2 h 10 min 17 and 21 as well as between 2 h10 min 26 and 36).

The sequence of appearance / disappearance of crossbars on the left and right PFD was as follows:

Time period	LFD	RFD	Vertical mode	Lateral mode
before 2 h 10 min 08			ALT CRZ	HDG
2 h 10 min 08 - 17				
2 h 10 min 17 - 21			ALT CRZ *	HDG
2 h 10 min 21 - 26				
2 h 10 min 26 - 36			V/S +6000	HDG
2 h 10 min 36 - 42				
2 h 10 min 42 - 43			V/S +1400	HDG
2 h 10 min 43 - 47				
2 h 10 min 47 - 2 h 11 min 40			V/S +1400	HDG
2 h 11 min 40 - 2 h 12 min 52				
2 h 12 min 52 - 2 h 12 min 58			V/S +1400	HDG
2 h 12 min 58 - 2 h 13 min 57				
2 h 13 min 57 - 2 h 13 min 58			Not recorded- period of associated parameter sampling insufficient	
2 h 13 min 58 s - end of flight				

The following graph represents the maximum and minimum positions of the FD crossbars displayed between the disconnection of the autopilot and 2 h 11 min 40, as well as the longitudinal inputs made by the copilot on his sidestick:

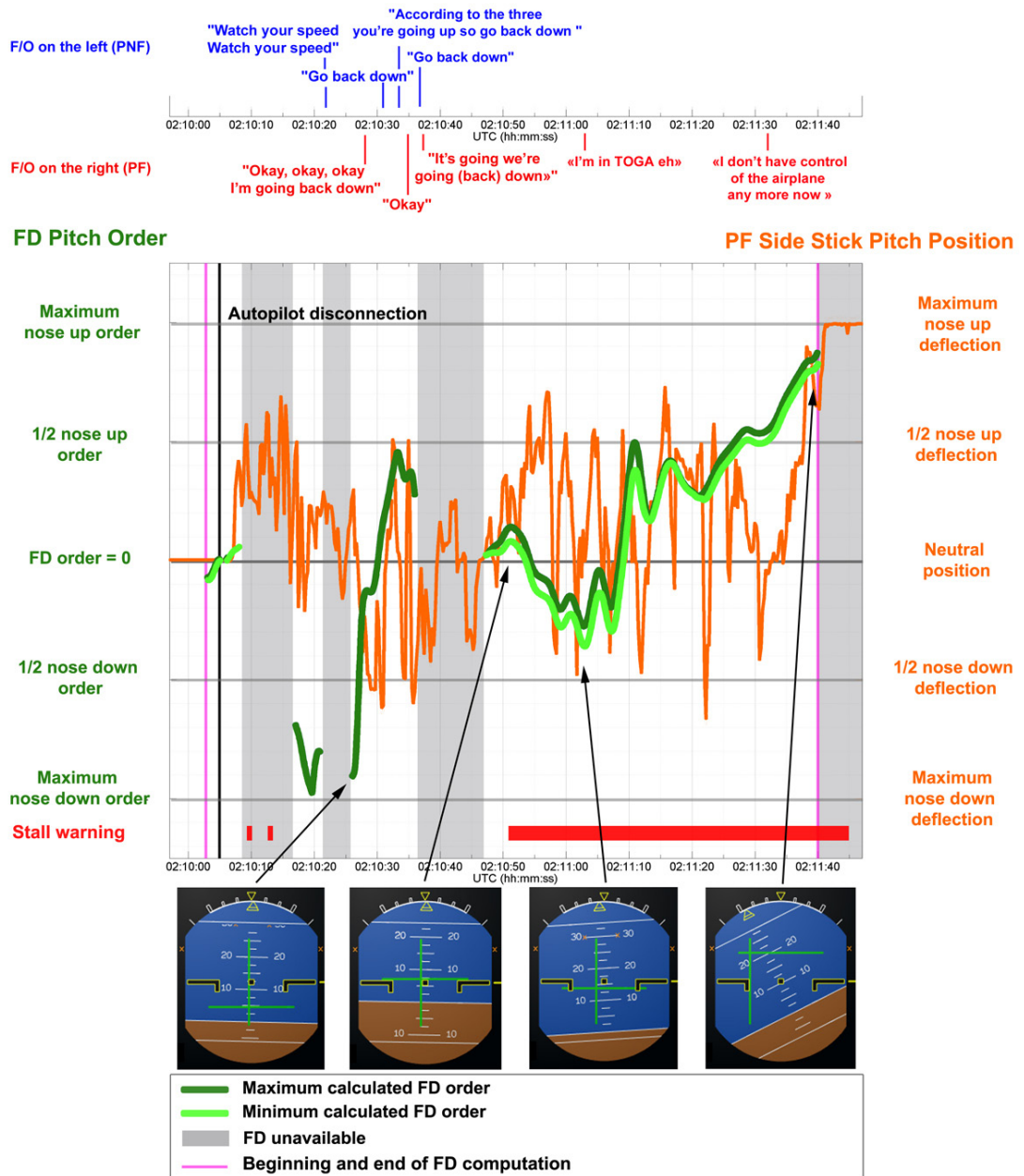

Figure 69: Evolution of FD crossbars

1.16.5.5 Analysis of the sequence of appearance of ECAM messages

The drop in the measured airspeed triggered monitoring within the various computers (refer to the analysis of the ACARS messages in interim reports 1 and 2), which in turn led to the loss of automatic systems and the appearance of ECAM messages.



Figure 70: Position of the area where ECAM messages are displayed

Seven lines are available on the ECAM for the display of messages. If the number of lines required to display all the messages exceeds this number, a green arrow pointing downwards appears to indicate that other messages of lower priority have not been displayed. To make them appear, the crew must process the first messages, then clear them. It is not possible to know if any of the crew members cleared one or more ECAM messages during the event, however, no announcement to this effect was made.

If the assumption is made that no message was cleared, and without taking into consideration the NAV TCAS FAULT message, the statuses of the ECAM at different times would have been as follows:

<p>ECAM 02:10:05</p> <p>AUTO FLT AP OFF</p>		<p>ECAM 02:10:08</p> <p>AUTO FLT AP OFF F/CTL ALTN LAW (PROT LOST) -MAX SPEED.....330/.82 AUTO FLT REAC W/S DET FAULT</p>	
<p>ECAM 02:10:10</p> <p>AUTO FLT AP OFF AUTO FLT A/THR OFF -THR LEVERS.....MOVE F/CTL ALTN LAW (PROT LOST) -MAX SPEED.....330/.82 AUTO FLT</p>		<p>ECAM 02:10:15</p> <p>AUTO FLT AP OFF ENG THRUST LOCKED -THR LEVERS.....MOVE AUTO FLT A/THR OFF -THR LEVERS.....MOVE F/CTL ALTN LAW (PROT LOST)</p>	AUTO FLT ↓
<p>ECAM 02:10:19</p> <p>AUTO FLT AP OFF ENG THRUST LOCKED -THR LEVERS.....MOVE AUTO FLT A/THR OFF -THR LEVERS.....MOVE F/CTL ALTN LAW (PROT LOST)</p>	F/CTL AUTO FLT ↓	<p>ECAM 02:10:24</p> <p>AUTO FLT AP OFF AUTO FLT A/THR OFF F/CTL ALTN LAW (PROT LOST) -MAX SPEED.....330/.82 F/CTL RUD TRV LIM FAULT</p>	AUTO FLT ↓
<p>ECAM 02:12:44</p> <p>AUTO FLT AP OFF NAV ADR DISAGREE -AIR SPD.....X CHECK •IF NO SPD DISAGREE -AOA DISCREPANCY •IF SPD DISAGREE -ADR CHECK PROC...APPLY</p>	AUTO FLT F/CTL ↓		

Figure 71: ECAM displays at different moments (if no message has been erased)

1.16.5.6 Contribution from the analysis of the ACARS messages

Most of the maintenance messages analysed in the interim reports can be correlated with data extracted from the flight recorders.

This correlation confirmed the preliminary analyses written up in the interim reports. Study of the transmission times between the computers that identified the triggering of the monitoring and the CMC also made it possible to explain and check the order in which the messages were sent by ACARS. This order may differ from the order of appearance of the ECAM messages.

It should however be noted that an error was made in the analysis of the "FLAG FPV ON PFD CAPT (F/O)" message. This had been explained by the combination of two conditions: that the TRK-FPA mode had been selected by the crew, and that the FPV was unavailable. In fact, the first of these conditions is not taken into consideration when sending the message to the CMC. The fact that the status of the FDR parameter, which indicates the transition from HDG-VS mode to TRK-FPA mode, did not change during the flight confirms that the crew did not at any time select TRK-FPA mode.

The end of the flight occurred shortly after the sending of the last maintenance message "Maintenance status ADR 2", which confirms the reason for the absence of an associated fault message: the correlation window opened for a period of one minute could not close and the fault message was not sent.

1.16.5.7 Calculation of REC MAX and OPTI

A calculation simulation was performed of the REC MAX flight level by the FMS between 1 h 45 and 2 h 09 min 30. In order to ensure the representativeness of the calculation in relation to what could have been presented to the crew during the flight, the tropopause altitude that the crew had entered in the INIT A page of the FMS had to be known. Given the operational procedures in force at the time of the event, the default altitude proposed by the FMS (36,090 ft) was selected.

According to the recorded FDR parameters (particularly temperature and mass), the simulation showed that the REC MAX varied little over the period in question, between FL 372 and FL 376. The difference in temperature compared to the standard atmosphere was quite stable at +11 °C, except between 1 h 51 and 1 h 59 when the difference was smaller and the minimum of +9 °C was reached.

The REC MAX calculated at 1 h 45 was FL 372 and the general tendency to increase was around 100 ft per ton of lost mass (or about 9 minutes of flight). The reduction of temperature at 1 h 50 was expressed by a local maximum of REC MAX at FL 375. It then reduced to FL 374 at 2 h 00.

Note: at 1 h 52, the PF said to the Captain "you see the REC MAX has moved to three seventy-five", which seemed to correlate to this extreme of recalculated REC MAX.

HYPOTHESIS:

•A330-200 GE CF6-80E1A3
•FMGEC Thalès: P/N C13039BA01
•Perf Data Base: P/N G8252AAA02

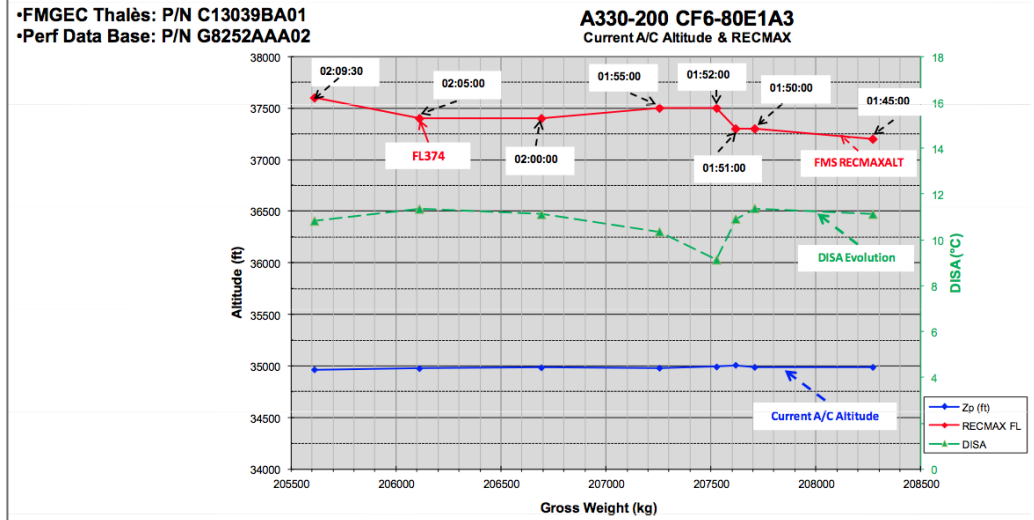

Figure 72: Evolution of the REC MAX (simulation) Source Airbus

The optimal flight level (OPTI) was recalculated using the information from the flight plan and the cost index used at Air France (80). This calculation indicated that the OPTI was about 37,000 ft flying over ORARO point, increasing in the same order of magnitude as the REC MAX.

1.16.6 Simulation of flight AF 447 in the Eurocat system

The BEA, working with Thales, the Eurocat system designer, organised a simulation of flight AF 447 connected in ADS-C with the DAKAR Oceanic ACC.

The purpose of this test was to determine if the triggering of the safeguard system installed in the system could have provided a more precise position of the aeroplane.

The following possibilities were postulated:

- The flight plan was integrated in the Eurocat system in DAKAR;
- AF 447 flight was connected in ADS-C.

The configuration of the system was that in force at the time of the accident. The following functions were triggered:

- Position and altitude report every 896 seconds, about 15 minutes;
- Position and altitude report during passage of the points flown over in the DAKAR Oceanic FIR. The report function also sent the estimates of FMS point n+1 and n+2;
- Warning during a change of altitude of ± 200 ft;
- Warning during a change of route of more than 10 NM;
- Warning during the absence of a position report.

In the absence of a report message, the system signals it after 3 minutes. This lapse of time enables a connection problem or information transmission delay to be cleared up.

The connection of flight AF 447 with DAKAR Oceanic in ADS-C would in this way have generated the following information:

- Altitude change message (2 h 10);
- Warning message of non respect of altitude (2 h 17);
- Messages of non periodic position report and of passage of reporting point (2 h 20);
- Loss of ADS-C connection message.

In this context the DAKAR controller could have attempted to contact the crew of flight AF 447.

The flight connection time associated to the position reports period (896 seconds) did not enable position information to be obtained after 2 h 10 min (position provided by ACARS in addition). Thus the current configuration system did not make it possible to restrict the wreckage search area. However, a critical phase could have been triggered earlier.

The ATLANTICO controller would have been warned of the altitude change by his system if flight AF 447 had been connected in ADS-C.

1.16.7 Aspects relating to fatigue

The professional timetable of the three crew members during the month that preceded the accident flight shows that the limitations on flight and duty times, as well as rest times, were in accordance with the provisions of European Regulation (EC) n°859/2008 of the European Commission (sub-section Q of Annex III).

The investigation was not able to determine exactly the activities of the flight crew members during the stopover in Rio, where the crew had arrived three days earlier. It was not possible to obtain data on their sleep during this stopover.

This lack of precise information on their activity during the stopover, in particular in relation to sleep, makes it impossible to evaluate the level of fatigue associated to the flight crew's duty time.

The CVR recording does, however, make it possible to show that the crew showed no signs of objective fatigue, as the following elements indicate:

- The level of activity and implication of the augmented crew in the first part of the flight, with the Captain and the copilot seated in the right seat, then in the second part of the flight with the two copilots, are in accordance with what is expected from a crew in the cruise phase. No signs of drowsiness or sleepiness are noticeable;
- At 0 h 58 min 07, the Captain was concerned with the state of fatigue of the copilot in the right seat. («try maybe to sleep twenty minutes when he comes back or before if you want») who answered that he didn't want to sleep;
- Questioned on his return to the cockpit, the copilot who took the Captain's place answered that he had "dozed".

1.16.8 Work on Human Factors

This accident, like any accident, signalled the failure of at least part of the provisions that were supposed to guarantee the safety of this flight in the situation encountered or in analogous situations. These provisions involve on a general level the certification of the aircraft systems design and its cockpit, principles of continuing airworthiness, rules of operational use and particularly normal, rescue and emergency procedures, and the behaviours and skills expected of the crews, and therefore especially their training and practice. This set of provisions includes among others explicit areas: regulatory provisions, procedures to follow, design features, operational limitations etc. which were designed to keep the flight safe. It also includes implicit areas that are more or less clear: "good practice", "reasonable expectations" regarding behaviour, indeed even very implicit assumptions or suppositions about the behaviour of the various parties.

The aim of the analysis was to determine the sub-group of the provisions that affected the expected behaviours and skills of the crews for the situation encountered. This involved identifying the failures that occurred during the flight, in relation to the explicit or implicit expectations of the safety model.

Beyond the simple discovery of a psychologically probable, likely or plausible explanation of the behaviours recorded, this involved assessing the degree of specificity or generality of the behavioural responses recorded: are they specific to this particular crew, shared by all the airline's crews, or can they be generalised to all crews? With regard to human factors, the behaviour observed at the time of an event is often consistent with, or an extension of, a specific culture and work organisation. The traits of the crew's habitual operation may be perceived in the elements collected during the investigation, and particularly in all that the CVR may reveal before the critical phase. To put it another way, it involved answering the question: "if another crew were substituted for this one, would the same responses be obtained (probably, probably not; certainly, certainly not)?" The final aim was in fact to contribute to identifying what should be modified in the whole of the safety provisions to significantly increase their effectiveness in a similar situation or in a generic situation including the same fundamental characteristics. However, the type of modifications to be made depends partly on the answer to the previous question.

Thus, using the work of the other investigation working groups, the work of the Human Factors group served as the basis to draw up the accident scenario as detailed in part 2.1 of this report.

1.16.8.1 Management of a sudden anomaly and implications on human performance

In some cases, maintaining flight safety after the appearance of an anomaly (or even the acceptability of an anomaly) supposes appropriate crew intervention. First of all, it is expected that the crew ensures control of the aeroplane and follows the flight path.

The intention is then that the crew will detect the anomaly, that they will possibly "make sense" of this detection, that they will modify their priorities on tasks in progress, and that they will take the corresponding action, (control inputs and/or acting on processing malfunctions, associated with procedures or check-lists), all of this in the expected timeframe (whose order of magnitude is indicated in the certification logic if it is critical).

On the A330, the ECAM proposes actions to be carried out in the majority of failure or emergency cases. From the information available on the ECAM, the crew must analyse and confirm the type of failure before undertaking any failure processing action. In other cases, the “adequate reaction” expected of the crew supposes immediate memory items with the purpose of stabilising the situation, then recourse to action instructions available on the ECAM, and/or recourse to procedures explained in the QRH and classified by category of diagnosed anomaly.

In all cases, this includes a specific number of implications concerning human performance, which may be based on what can reasonably be expected of any human operator (for example noticing a clearly audible aural signal), or generic professional abilities normally present in the pilot community (“basic airmanship”), or even specific abilities which must be explicitly developed through a specific training course and / or practice.

In addition, these expected reactions result from various cognitive modes of activity. Human operators notice and act according to their mental representation of the situation, and not to the “real” situation. The probability and speed of detection of anomaly signals is connected to their “salience”, that is to say to their ability to destabilise and modify the representation of the situation in progress, all the while being situated possibly outside the frame of this representation (that is to say unexpected, surprising, absurd, even “unthinkable” in its context). Depending on the frequency of the operator’s exposure to the anomaly during his training or in real operations, his response may be automatic, applying rules, or developed on the basis of in-depth knowledge. Automatic responses assume recognition of very specific stimuli, to which the reaction is associated without true interpretation. Applying rules assumes not only their knowledge, but also the recognition of their conditions of applicability, and therefore the correct identification plus a specific interpretation of the anomaly. The construction of a response by calling on experience assumes incorporation of the anomaly in the mental representation of the situation, which can go via its destruction/reconstruction, very wasteful in resources and time-consuming. In this way the correct perception of the situation by a crew, which enables the reliability and speed of diagnosis and decision to be improved, is linked not only to the way in which the situation is presented to this crew (interfaces, parameters) but also to their training and experience.

Based on the preceding, for a good chance that these expectations of the crew may be met, it is therefore necessary:

- That the signs of the problem are sufficiently salient to bring the crew out of their preoccupations and priorities in the flight phase in progress, which may naturally be distant from strict monitoring of the parameter(s) involved in the anomaly;
- That these signs be credible and relevant;
- That the available indications relating to the anomaly are very swiftly identifiable so that the possible immediate actions to perform from memory to stabilise the situation are triggered or that the identification of the applicable procedure is done correctly. In particular, it is important that the interfaces that usually carry anomaly information display, or at least allow, this initial diagnostic, given the minimum competence expected of a crew. Failing this, it is necessary to offset the lack of information supplied by the system which would enable the diagnostic to be reached by specific training;

- ❑ That the memory items are known and sufficiently rehearsed to become automatic reflexes associated only with awareness of the anomaly, without the need to construct a more developed understanding of the problem;
- ❑ That there are no signals or information available that suggest different actions or that incite the crew to prior reconstruction of their understanding the situation.

1.16.8.2 Case of speed display anomalies

The philosophy for processing the anomaly is described in the “UNRELIABLE AIRSPEED INDICATION / ADR CHECK PROCEDURE” that is in Flight Manual (AFM) and transcribed in the Airbus FCOM and the Air France Operations Manual.

Airbus

The FCOM procedure indicates that:

- ❑ The crew identifies the loss of consistency in indicated airspeeds;
- ❑ And if the safety of the flight is affected by the indicated speed anomaly, and until the aeroplane reaches the safety altitude or the aerodrome circuit altitude, the crew first performs the Memory items indicated in the “UNRELIABLE AIRSPEED INDICATION / ADR CHECK PROCEDURE” inset. The objective of these memory items is to maintain the aeroplane within a safe flight envelope and to stabilize the flight path to allow time to find, in the QRH, the tables giving the more precise pitch attitude and thrust values to be used for the flight :

	ABNORMAL AND EMERGENCY	3.02.34	P 18
	NAVIGATION	SEQ 210	REV 24

R UNRELIABLE SPEED INDIC/ADR CHECK PROC (CONT'D)

● If the safe conduct of the flight is impacted :

MEMORY ITEMS :

- AP/FD.....OFF
- A/THR.....OFF
- PITCH/THRUST :
 - Below THRUST RED ALT.....15°/TOGA
 - Above THRUST RED ALT and Below FL 100.....10°/CLB
 - Above THRUST RED ALT and Above FL 100.....5°/CLB
- FLAPS.....Maintain current CONFIG
- SPEEDBRAKES.....Check retracted
- L/G.....UP

When at, or above MSA or Circuit Altitude: Level off for troubleshooting

Figure 73: Source: Airbus FCOM supplied to Air France

- ❑ Whether or not they applied the immediate actions, the crew follows the “UNRELIABLE AIRSPEED INDICATION / ADR CHECK PROCEDURE” procedure in order to :
 - initially ensure that the automatic systems (AP / FD / ATHR) are de-activated
 - based on the procedure tables, adjust the pitch attitude and the thrust in order to maintain the aeroplane in level flight;

R R R	– GPS ALTITUDE Display on MCDU			
	● To level off for troubleshooting :			
	– AP/FD OFF			
	– A/THR OFF			
	<i>Note : Check the actual slat/flap config. on ECAM, as flap auto-retraction may occur.</i>			
	PITCH/THRUST FOR INITIAL LEVEL OFF			
SLATS/FLAPS EXTENDED				
		Above 190 t	190 t – 160 t	Below 160 t
CONF	Speed	Pitch (°)/Thrust (% N1)		
3	F	7.5/76.6	7.5/70.7	7/64.3
2	F	9/75	9/69.2	8.5/62.4
1 + F	S	6/72.7	6/66.9	6/60.5
1	S	9/71.6	9/65.7	9/59.5
CLEAN				
FL	Speed	Pitch (°)/Thrust (% N1)		
Below FL 250	240 kts	5/75.7	4/72.6	2.5/68.1
FL 250 - FL 370	260 kts	3.5/90	3/87.9	2/83.9
Above FL 370	M 0.80	3/94.3	2.5/93.4	2/90

Figure 74: Source FCOM Airbus

- identify the ADR(s) affected.

Air France

Air France split the Airbus “UNRELIABLE AIRSPEED INDICATION / ADR CHECK PROCEDURE” procedure into two parts. In its Operations Manual, it introduced:

- An emergency manoeuvre called in French “IAS DOUTEUSE” in the “Procédures Anormales, Manœuvres d’urgence” chapter. The emergency manoeuvre⁽¹¹⁾ must be carried out using memory items by the crew when there is a doubt on the reliability of a speed indication and if the conduct of the flight is dangerously affected. It repeats the items from the inset in the Airbus procedure:

⁽¹¹⁾Immediate action undertaken from memory when the safety of the flight is directly compromised. It is repeated in the QRH for individual skills maintenance.

A330/340	Procédures anormales	TU 03.01.01. 03
AIR FRANCE	MANOEUVRES D'URGENCE	15 FEB 07
OANT		
IAS DOUTEUSE		
SI CONDUITE DU VOL AFFECTEE DANGEREUSEMENT, le CDB annonce "IAS DOUTEUSE", effectuer les actions immédiates suivantes :		
PF	AP	OFF
C/P	FD 1 et 2	OFF
PF	A/THR	OFF
PF	POUSSEE / ASSIETTE	SELECTEES
➤ Avant la réduction de poussée :		
	- POUSSEE / ASSIETTE (A330)	TOGA / 15°
	- POUSSEE / ASSIETTE (A340)	TOGA / 12°5
➤ Après la réduction de poussée :		
	● Au dessous du FL 100	
	- POUSSEE / ASSIETTE	CLB / 10°
	● Au dessus du FL 100	
	- POUSSEE / ASSIETTE	CLB / 5°
PNF	VOLETS	CONFIG MAINTENUE
PNF	SPEED BRAKES	VERIFIES RENTRES
PNF	TRAIN	RENTRE
Respecter les alarmes décrochage.		
LORSQUE LA TRAJECTOIRE EST STABILISEE, se référer à la procédure URGENCE / SECOURS non ECAM "VOL AVEC IAS DOUTEUSE / ADR CHECK PROC" (QRH 1.34.xx ou TU 03.02.34.1XX).		

Figure 75: Source TU Air France

□ A non-ECAM urgency/emergency procedure, called in French, “VOL AVEC IAS DOUTEUSE / ADR CHECK PROCEDURE” that must be followed by the crew and if the conduct of the flight does not seem to be dangerously affected or when the flight path is stabilized after a previous emergency manoeuvre. This procedure reminds the crew firstly of the immediate actions in the emergency manoeuvre. It then provides a table of the values for pitch attitude and thrust to select to ensure level flight. When the flight path is stabilized, the crew must then identify the ADR(s) affected by following the procedure. In case the crew does not apply the emergency manoeuvre as they consider that the safety of the flight is not affected, the procedure does not remind them to de-activate the automatic systems. The Operations Manual details the rules for applying the procedure and mentions:

- *“If the erroneous speed or altitude information does not affect flight safety (flight path stabilized),*
- *[...]*
- *If flight safety is affected: (all the speed indications are erroneous, or if the false speed indication cannot be clearly identified)...”*

1.16.8.3 Response to aural warnings

Numerous studies have been conducted on insensitivity to aural warnings and they showed that the aggressive nature, rarity and unreliability of these warnings may lead operators to ignore these signals [1, 2]. In particular, in the event of a heavy workload, insensitivity to aural warnings may be caused by a conflict between these warnings and the cognitive tasks in progress. The ability to turn one’s attention to this information is very wasteful as this requires the use of cognitive resources already engaged on the current task. The performance of one of these tasks (solving the problem or taking the warning into account) or of both would be affected [3].

In addition, studies on the visual-auditory conflict show a natural tendency to favour visual to auditory perception when information that is contradictory and conflicting, or seen as such, of both senses is presented [4, 5, and 6]. Piloting, calling heavily on visual activity, could lead pilots to a type of auditory insensitivity to the appearance of aural warnings that are rare and in contradiction with cockpit information. A recent study in electrophysiology on a piloting task seems to confirm that the appearance of such visual-auditory conflicts in a heavy workload situation translates into an attention selectivity mechanism that favours visual information and leads to disregarding critical aural warnings [7].

[1] Parasuraman, R., & Riley, V. (1997). *Humans and automation: Use, misuse, disuse, abuse. Human Factors: The Journal of the Human Factors and Ergonomics Society*, 39(2), 230-253.

[2] Doll, T. J., Folds, D., & Leiker, L. A. (1984). *Auditory information systems in military aircraft: Current configurations versus the state of the art. Final Report, 1 May-30 Sep. 1983 Georgia Inst. of Tech., Atlanta. Systems Engineering Lab., 1.*

[3] Wickens, C. D. (1980). *The structure of attentional resources. Attention and performance VIII*, 8.

[4] Colavita, F. B. (1974). *Human sensory dominance. Attention, Perception, & Psychophysics*, 16(2), 409-412.

[5] Sinnett, S., Spence, C., & Soto-Faraco, S. (2007). *Visual dominance and attention: the Colavita effect revisited*. *Percept Psychophys*, 69(5), 673-686.

[6] Yuval-Greenberg, S., & Deouell, L. (2009). *The dog's meow: asymmetrical interaction in cross-modal object recognition*. *Experimental brain research. Experimentelle Hirnforschung. Expérimentation cérébrale*, 193(4), 603.

[7] Scannella, S. (2011), *Bases cérébrales du conflit visuo-auditif spatial et sémantique : études en IRM fonctionnelle et EEG. Chapitre "Etude du conflit visuo-auditif sémantique dans l'activité de pilotage"*.

1.16.8.4 Statements by other crews faced with similar situations

A comparative analysis of reports and statements by other crews based on seventeen events that occurred in similar conditions to those of AF447, two of which are studies in 1.16.2, brought to light the following trends:

- ❑ Analysis of the situation by crews appears difficult;
- ❑ Calling on the « unreliable airspeed » procedure was rare;
- ❑ Some crews mentioned the difficulty of choosing a procedure bearing in mind the situation (numerous warnings);
- ❑ Others did not see the usefulness of applying this procedure given that in the absence of doubt about the unreliability of the airspeeds, their interpretation of the title of the "unreliable airspeed " procedure did not lead them to apply it;
- ❑ Some gave priority to controlling the pitch attitude and thrust before doing anything else;
- ❑ The triggering of the STALL warning was noticed. It was surprising and many crews tended to consider it as inconsistent.

1.16.9 Examination of the cockpit seats

This paragraph details the examinations carried out on elements of the cockpit seats that were brought to the surface and identified.

1.16.9.1 Description of the cockpit seats

The cockpit has four seats: the Captain's seat on the front left side, the co-pilot's seat on the front right, as well as a third occupant's seat, similar to the two pilot seats, and a fold-down seat for a fourth occupant.

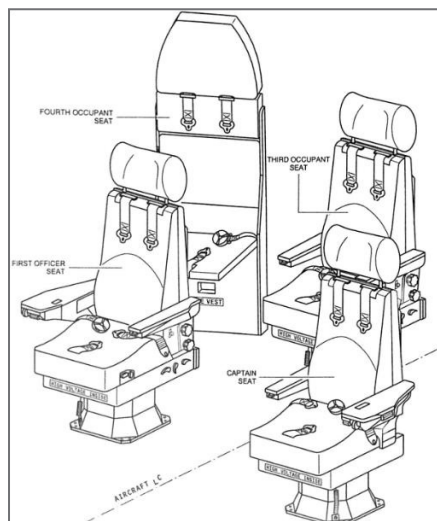

Figure 76: View of the cockpit seats

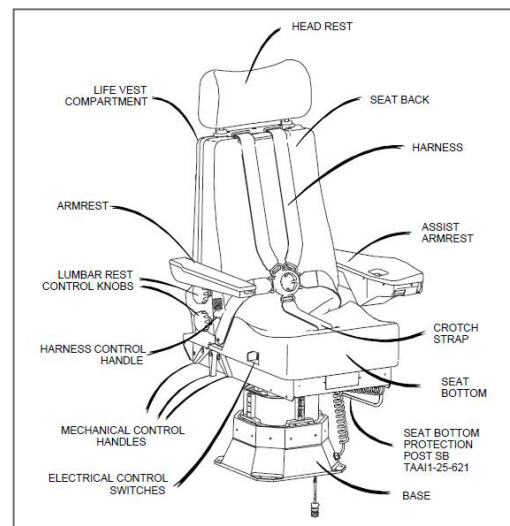

Figure 77: General view of the left seat

Of the seats recovered, only the two pilot seats were examined in order to determine their position at the time of the event.

The two pilot seats are symmetrical in relation to the axis of the aeroplane. The main adjustments of the pilot seats are:

- ❑ The horizontal position;
- ❑ The vertical position or height;
- ❑ The arm-rest position on the side-stick side;
- ❑ The angle of the back of the seat.

The other adjustments (central armrest and lumbar cushions) are secondary.

When the horizontal position is being adjusted, the seat moves on its base via two systems:

- ❑ A rack and pinion system enabling the translational movement of the seat;
- ❑ A guidance system ensuring the seat is maintained facing the control panel.

For the rack and pinion system, the pinion and its electric motor are fixed to the base; the L-shaped rack is fixed under the seat cushion. The shape of this rack allows the longitudinal positioning movement of the seat and lateral movement when the seat is in its most aft position (position called storage position, allowing access to the seat). The longitudinal setting range is 226.6 ± 2 mm.

The guidance system is made up of two rails and two racks, located under the seat cushion, and of an 8-roller carriage set and two pinions, fixed to the base.

Adjustment of the horizontal position of the seat is usually electric. The motor can be disconnected for mechanical adjustment.

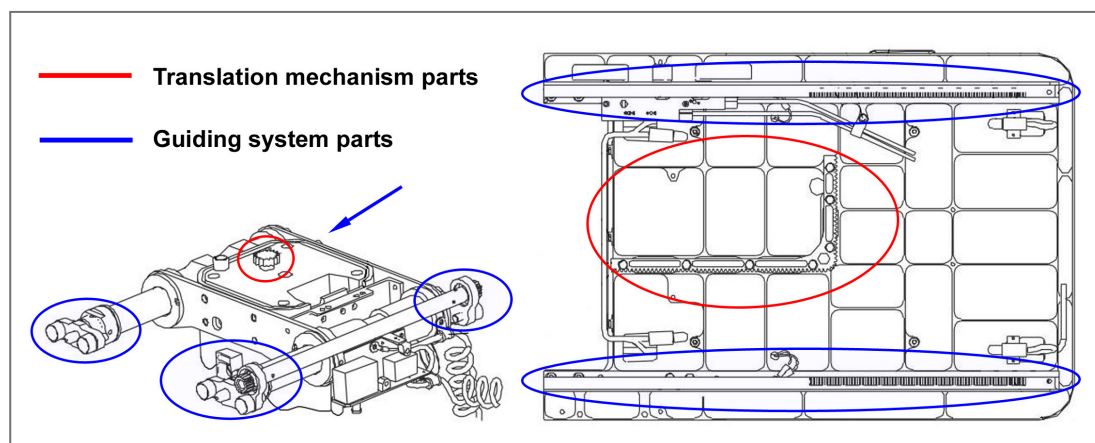

Figure 78: The seat's horizontal position adjustment systems

Adjustment of the vertical position is made via a worm screw system positioned in the base. The setting range is 165.1 ± 2 mm. This adjustment is usually electric. The motor can be disconnected for mechanical adjustment.

The armrest on the side-stick side has two adjustment knobs. The knob located at the front of the armrest allows the height to be adjusted. The second one located on the outer side of the armrest enables the angle to be adjusted.



Figure 79: Right seat armrest on the side-stick side

Adjusting the angle of the seat back is mechanical and is done using two locks fixed to the back of the seat. These locks consist of a threaded rod and a threaded nut on its semi-circumference. This specific tooling enables the nut to move the length of the rod and the position to be locked. These rods come out of the nut completely when the back of the seat is placed upright to its maximum (7° in relation to the vertical) and are completely drawn in when the back of the seat is tilted (34°).

The two seats have a five-point safety harness made of two shoulder straps, two lap belts (the buckle being fixed to the lap belt on the side-stick side), and a crotch strap (see the general view of the seat).

1.16.9.2 Examination of the left side seat

The parts of the left seat that were examined were the seat (seat cushion and back) and the harness.

The marks left by the adjustment mechanism under the seat cushion enabled the horizontal position of the seat on impact to be determined: the seat was pushed back and moved to the left (in the "storage" position).



Figure 80: Roller marks on the guidance rail

During examination, the threaded rods of the two tilt adjustment bolts of the back of the seat had partially come out asymmetrically. Additional examinations did not enable the positions deduced from observation of these bolts to be validated and consequently to deduce the tilt angle of the back of the seat.

The shoulder straps and crotch strap were recovered unattached; the examinations confirmed that they were not fastened on impact. Only the lap belt was recovered fastened.

1.16.9.3 Examination of the right side seat

The parts of the right side seat that were examined were the seat (seat and back of the seat), the harness, the height adjustment mechanism, as well as the armrest on the side-stick side.

The marks left by the adjustment mechanism under the seat cushion enabled the horizontal position of the seat on impact to be determined. The seat was positioned 5.5 cm from the most forward position.



Figure 81: Right side seat cushion

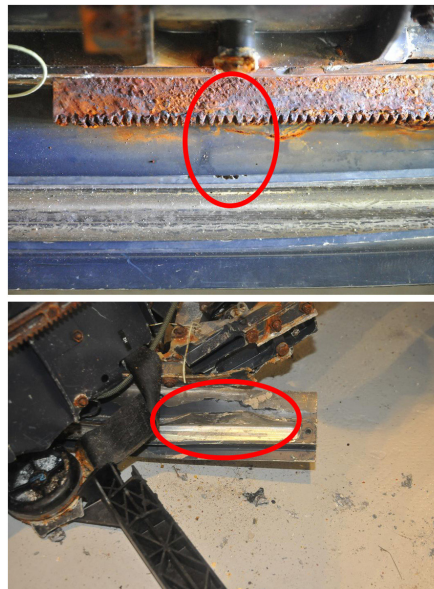

Figure 82: Marks on the adjustment mechanism

The threaded rods of the two tilt adjustment bolts were recovered almost completely drawn in, asymmetrically. For the same reasons as those explained for the left side seat, the positions deduced from observation of these bolts were not validated.

The seat's height adjustment mechanism was frozen at a height of 7.5 cm. The seat height may have been modified during impact. The height before impact may have been slightly higher (clutch slip).

The armrest was recovered in the up position, a probable consequence of the impact. The armrest position was indicated on the dial dedicated to this function. The needles were positioned on A values (adjustment from A to K for height) and 3 (adjustment from 1 to 9 for tilt angle). The armrest cladding was dismantled in order to check mechanism integrity and validate the needle positions. The mechanisms were demonstrated to be irreversible during certification tests, that is to say that leaning on the armrest did not modify the adjustments made with the knobs.

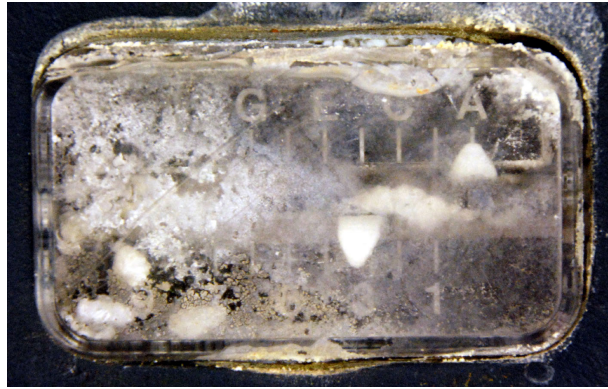

Figure 83: Dial indicating armrest position

The shoulder straps, the left lap belt and crotch belt were recovered detached. Examinations showed that on impact the left lap belt and crotch belt were locked and that the shoulder straps were not.



Figure 84: Malformation of the crotch belt fastening

1.16.9.4 Summary

The left side seat was in the “storage” position on impact. The pilot (PNF) was attached via the lap belt.

The right side seat was positioned 5.5 cm from the most forward position with a right side armrest bearing the indication of A3 adjustment. This adjustment is consistent with the piloting position of a pilot with the morphology of the PF. The pilot (PF) was attached via lap and crotch belts.

1.17 Information on Organisations and Management

1.17.1 Organisation of Air France

The airline had, at the time of the accident, an AOC that had been issued on 8 July 2008 and was valid until 8 July 2011.

Note: The previous AOC dated from September 2006 and was valid until 30 September 2009: it had been re-issued on 8 July 2008 as a result of adoption of the EU OPS. Its current AOC was issued on 1st July 2011 and is valid until 1 July 2014.

1.17.1.1 Preparation and monitoring of flights

1.17.1.1.1 Flight monitoring conducted by the operator

➤ OCC (Operational Control Centre)

The OCC coordinates the entire programme of flights operated by Air France and its partners. It carries out all the following control tasks: changes to aircraft rotation, changes to crew rosters, time zone adjustments, flight cancellations, changes to an aircraft's route, switching aircraft, putting on additional or special flights, renegotiating ATC slots, etc. Maintenance personnel working within the OCC provide the interface between the OCC and the hub's maintenance centre (HMC).

In case of a major event, the OCC activates the crisis centre.

➤ ACARS position report for long-haul aircraft.

The basic principle is that real-time position information is received from the monitored aircraft and displayed using the Sailor system. All the position reports are displayed simultaneously on a screen at the OCC and are indicated to a dispatcher as a yellow aircraft. When the aircraft sends its position, it is displayed in green. If the aircraft's flight path coincides with the path described in its flight plan then the two aircraft are overlaid.

The actual positions are taken from the ACARS position reports for long-haul aircraft every ten minutes.

So that dispatch can monitor the "true" flight, the position report function must be installed on the aircraft system with the correct registration, and the crew must not have disabled this function.

If the flight is monitored, the dispatcher will see an orange visual warning in the flight logging interface informing him/her that:

- Three successive position reports have not been received;
- The aircraft has deviated laterally from its scheduled route by more than 30 nautical miles.

N°Vol Commercial	Départ	Arrivée	Horaires	Temps de vol	Horaires	Inmat.	Etat PV/Vol	N° RC/Plan	Dég.	Dég. Validé	DER	ETF	Dég. ETF	Appui ETOPS	Appui ETOPS	Appui ETOPS	Appui ETOPS
AF6419	MEX	GDL	509:20	00:49	10:41	FGIUC	SansEffetATC	6337/0101	MEX	MEX	-	-	-	-	-	-	-
AF444	CDG	GIG	509:30	11:04	21:09	FGZCG	SansEffetATC	6471/0101	CNF	CNF	REC	-	-	SID	NAT	-	-
AF488	CDG	SXM	509:30	08:46	18:45	FGLZT	SansEffetATC	6332/0101	ANU	-	-	-	-	-	-	-	-
AF460	CDG	CCS	509:40	09:33	19:43	FGLZM	SansEffetATC	6429/0101	POS	-	POS	-	-	-	-	-	-
AF422	CDG	BOG	509:45	10:44	21:00	FGNII	SansEffetATC	6341/0101	CLO	CLO	CCS	-	-	-	-	-	-
AF608	ORY	CAY	509:45	08:21	18:27	FGLZH	SansEffetATC	6410/0101	PBM	-	-	-	-	-	-	-	-
AF3970	PTP	PDF	511:00	00:27	11:40	FGKXC	SansEffetATC	6433/0101	UWF	-	-	-	-	-	-	-	-
AF620	ORY	PTP	511:00	08:13	19:37	FGSQR	SansEffetATC	6503/0101	ANU	-	-	-	-	SMA	ANU	-	-
AF401	SCL	CDG	A20:20	13:13	10:02	FGSPQ	EnVol	5455/0101	ORY	ORY	OPO	-	-	B5B	BEL	SID	SMA
AF417	EZE	CDG	A20:56	12:04	09:37	FG5QD	EnVol	5443/0101	ORY	ORY	BOD	-	-	NAT	B.JL	-	-
AF406	CDG	SCL	A22:23	13:14	12:08	FGSPT	EnVol	5609/0101	MDZ	MDZ	COR	-	-	SMA	SID	BEL	B5B
AF442	CDG	GIG	A22:26	10:25	09:15	FGITF	EnVol	5562/0101	CNF	CNF	B5B	-	-	-	-	-	-
AF418	CDG	EZE	A22:33	12:29	11:23	FG2NA	EnVol	5469/0101	MVD	MVD	ASU	-	-	SID	FOR	-	-
AF454	CDG	GRU	A22:58	10:37	10:00	FG5QU	EnVol	5434/0101	VCP	VCP	CNF	-	-	SID	FOR	-	-
AF423	BOG	CDG	A23:20	09:39	09:30	FGLZS	EnVol	5761/0101	ORY	-	BES	-	-	-	-	-	-
AF461	CCS	CDG	A00:05	08:21	08:55	FGLZC	EnVol	5779/0101	ORY	ORY	OPO	-	-	-	-	-	-
AF459	GRU	CDG	A00:48	10:46	12:03	FG2CN	EnVol	5589/0101	ORY	ORY	BOD	-	-	NAT	B.JL	-	-
AF493	SDQ	CDG	A02:36	07:30	10:37	FG2NG	EnVol	5759/0101	ORY	-	BES	-	-	ANU	TER	OPO	-

Figure 85: A typical display on a flight logging interface.

➤ **HMC (hub maintenance centre)**

The hub maintenance centre is responsible for the line maintenance of aircraft operated by Air France and its contract carriers at Paris Charles-de-Gaulle. Experts follow the frequency in order to provide technical assistance at the request of crews. They contribute to resolving technical problems in order to allow aeroplanes to be returned to operations in the shortest possible time via specific systems (ACARS).

➤ **Crisis centre**

In the event of a major incident, the OCC's duty manager decides, in consultation with the OCC's 24-hour executive control function (COA) whether it is appropriate to activate the crisis centre (CC.AF). The CC.AF takes over the handling of the incident from the OCC, to ensure continuity of provision of this service. The CC.AF's work is carried out by on-call personnel who gather in a room specially set-up for this purpose, within the OCC centre. The appropriate decisions are made, which may involve activating peripheral crisis structures.

1.17.1.1.2 Documents relating to operation on trans-Oceanic routes

In its Complément aux Routiers Espaces Océanique (Supplement to Charts for Oceanic Airspace), dated 18 December 2008, Air France reiterates the provisions stated in document AIRAC AIP SUPPLEMENT SUP A065-074/08 dated 25 September 2008 regarding position report procedures and ADS-C logging-on procedures within the ATLANTICO FIR. This document states in particular:

- That position reports are mandatory at the waypoints designated on the fixed routes;
- That position reports are mandatory at the other waypoints used to define the route in the FPL;
- That the last position report prior to proceeding into a new FIR must also be sent to the organisation responsible for air traffic in the airspace into which the aircraft will proceed;
- The availability of the ADS service;
- The logging-on procedure required from the crews;
- That reporting points are transmitted automatically by ADS-C.

Note: If the ADS-C connection fails, the crew must report that they have passed these waypoints via HF.

Note: The ORARO, SALPU and TASIL waypoints constitute mandatory position reporting points.

1.17.1.1.3 Documents relating to operations within the DAKAR Oceanic FIR

The additional navigation and infrastructures information sheets included in the dossier for flight AF 447 state the following:

Crews are authorised to participate in CPDLC tests within the DAKAR Oceanic FIR, AT THE REQUEST OF ATC. However, the instructions from air traffic control MUST be confirmed by radio. Implementation of ADS-CPDLC within DAKAR Oceanic FIR:

LOGON: GOOO.

Logon 20 minutes before entering DAKAR Oceanic FIR.

Since this is a pre-operational deployment of the system, HF remains the primary means of communication.

1.17.1.1.4 Preparation and monitoring of AF 447

➤ Preparation of the flight by the central flight study service

Given the estimated load of 37.8 t, the flight dossier included a main flight plan at a standard Mach of M 0.82 with an ETF at Bordeaux Mérignac with alternate at Toulouse Blagnac as well as two additional direct flight plans, one at Mach 0.82 and the other at a “slower Mach”, i.e. M 0.81. A summary table of the loads offered enabled the crew to make the choice of the definitive flight plan from among these three options.

➤ Preparation of the flight at Rio de Janeiro

The Brazilian air traffic control service submitted the ATC flight plan to the air traffic control bodies of the regions overflowed at 19 h 12..

The flight crew of flight AF 447 arrived at the flight preparation room at the airport at around 20 h 00. The flight departure agent handed over the flight dossier to the crew. There was no modification of the dossier. The PPV copy signed by the Captain confirmed planned trip fuel of 63.9 tonnes with refuelling at the ramp of 70.9 tonnes and planned taxiing of 0.5 tonnes (giving 70.4 tonnes on take-off).

The crew informed the Rio station of its choice of a direct flight at mach 0.82.

➤ Meteorological data in the flight dossier

The meteorological charts were printed in black and white with the route plotted by computer. The following charts were handed over to the crew:

- The TEMSI chart valid on 1st June at 0 h 00 between FL 250 and FL 630;
- The wind and temperature charts valid on 1st June at 0 h 00 at FL100, FL180, FL300, FL340 and FL390;
- The CAT charts valid on 1st June at 0 h 00 at FL340 and FL390 (no clear air turbulence was forecast).

The SIGMET that may have been given to the crew were:

- SIGMET 5 SBRE (RECIFE) of 31 May from 18 h 00 to 22 h 00;
- SIGMET 7 SBAO (ATLANTICO) of 31 May from 18 h 00 to 22 h 00;
- SIGMET 7 GOOO (DAKAR Oceanic) of 31 May from 16 h 35 to 20 h 35. The route of flight AF 447 did not enter into the area of this SIGMET.

Note: The regulations do not make archiving of the SIGMET's in flight dossiers mandatory.

The crew also had the option of using a computer application (EOLE) to consult a colour screen and print in black and white other meteorological charts (particularly the tropopause and icing chart) and satellite photos. The investigation did not make it possible to say if they used these two possibilities.

➤ Flight monitoring

The following operational information was exchanged via ACARS:

- At 22 h 51 the crew asked for and received the METAR of the Brazilian aerodromes of Belo Horizonte, Salvador de Bahia and Recife,

- ❑ At 0 h 31 dispatch sent the following message:
 - BONJOUR AF 447
 - METEO EN ROUTE SAILOR :
 - PHOTO SAT DE 0000Z : CONVECTION ITCZ SALPU/TASIL
 - PREVI CAT : NIL
 - SLTS DISPATCH;
- ❑ At 0 h 33 the crew asked for and received the METAR and TAF for Paris Charles de Gaulle, San Salvador and Sal Amilcar airports;
- ❑ At 0 h 57 the crew inquired about the use of the second ETOPS backup aerodrome and dispatch replied at 1 h 02;
- ❑ At 1 h 13 the crew asked for and received the DAKAR, Nouakchott and Natal METAR and TAF;
- ❑ The regulatory bilateral contact before entering an ETOPS zone (SALPU, estimated at 1 h 48 by the crew) took place between 1 h 17 and 1 h 19.

Note: The crew could take the option of requesting SIGMET via ACARS. This function was not used by the crew.

1.17.1.2 Composition of the flight crew

The airline company agreements set the flight time limitations and rest periods within Air France according to requirements that are more restrictive than the regulations in force.

Within this framework, the maximum flying duty time is set at ten hours. This flying duty time can be extended to sixteen and a half hours by augmenting the crew. The flight time can then be extended to thirteen and a half hours.

Since the programmed flying duty time of flight AF 447 was 12 h 45, the flight crew was augmented and increased to three pilots (one Captain and two co-pilots).

1.17.1.2.1 Flight crew members rest on board

On Airbus A330-203 type aircraft operated by Air France, a rest facility intended for the flight crew is installed behind the cockpit. It includes two bunks.

The augmented crew members are present in the cockpit and actively monitor the flight from the departure briefing to FL200 and from the arrival briefing to the gate.

Outside of these flight phases, each member of the flight crew must be able to rest for at least an hour and a half continuously during the flight duty time.

The Captain sets the procedures for each member of the crew taking their rest.

1.17.1.2.2 Relief of the Captain

➤ Authority of the Captain

Air France's operations manual attributes to the Captain the command role which includes taking all the decisions necessary to complete his or her mission. The Captain is responsible for all aspects of flight conduct and must intervene whenever he or she considers it necessary.

➤ **In-flight relief of Captain**

The regulations⁽¹²⁾ state that the Captain may delegate flight responsibility to a Captain or, for operations performed above FL200, to another pilot. The latter must:

- Hold a valid airline pilot's licence;
- Have passed an adaptation course and operator's check (including the aircraft type rating);
- Have currency in all the specified recurrent training and periodic checks;
- Hold the specified route qualification.

In the Air France operations manual, the Captain's replacement was a co-pilot designated as relief pilot. Acting in this capacity, he made the necessary operational decisions for the flight in accordance with the Captain's instructions. He stayed in the right seat and from this seat carried out the PF function. He performed tasks marked "C" in the check-lists and emergency procedures.

The Captain is responsible, from the flight preparation phase onwards, for distributing the tasks to each crew member and for defining the possible scope of intervention of the relief pilot(s) during the flight when the basic crew is at the controls.

Before any prolonged absence, the Captain:

- Designates his or her replacement in compliance with part A of the operations manual;
- Confirms the new task-sharing;
- Specifies to the pilots the conditions requiring his or her return to the cockpit.

Note: The investigation has not made it possible to determine any task-sharing by the Captain at the time of flight preparation.

Note: The crew's licenses and ratings are not included in flight dossiers.

1.17.1.2.3 Specific briefings for flights with augmented flight crew

According to the Air France operations manual, before the Captain takes a rest period, a briefing must be given and the following points mentioned:

- Route: monitoring and resources used. ATC clearances and contact frequencies;
- Aircraft: technical status. Review of the fuel consumption, remaining fuel and configuration of the fuel system;
- Meteorology: relevant information about the journey.

1.17.1.3 Operational instructions

1.17.1.3.1 Definitions

➤ **By the operator**

- Emergency manoeuvre: an immediate action performed from memory when the safety of the flight is directly compromised. It is noted in the QRH for the maintenance of individual skills currency.

The content and the task-sharing of an emergency manoeuvre must be known by heart by all flight crew.

⁽¹²⁾European Commission Regulation N° 859/2008 of 20 August 2008, called EU-OPS appendix 1 to OPS 1.940.

- ❑ Emergency procedure: action performed from a do-list when the safety of the flight is directly compromised:
 - Dangerous configuration or at the limit of the flight envelope,
 - Failure of a system that impairs flight safety;
- ❑ Backup procedure: action performed from a do-list when the safety of the flight is not directly compromised:
 - Failure of a system that has no immediate consequence on the safety of the flight,
 - Failure causing the loss of redundancy or degradation of a system;
- ❑ Additional abnormal procedure: abnormal procedure linked to a degradation of an aeroplane system that does not require the application of an emergency or backup procedure.

Note: The standard handling of an abnormal additional procedure is as follows: complete readout by the PNF of the procedure then performance of the procedure from a do-list with cross-checking.

- ❑ Action-check: when the pilot takes action on a system or on a control in the cockpit, s/he must do so in the form of a two-step process:
 - Action: the pilot makes a control input,
 - Check: the pilot ensures that the result of this input complies with his/her initial intention.
- ❑ Cross-check: pilots must work as a team and cross-check each other's actions to ensure optimum flight safety. This cross-checking applies to all tasks: flight path handling, system implementation, communications with ATC, etc. Any deviation from the planned flight profile or from standard procedures must be clearly called out.
- ❑ Technical call-outs: the use of technical callouts formalises exchanges and facilitates communication within the cockpit, particularly during phases in which there is a high workload. Technical callouts are used to give a command, initiate an action or inform the other flight deck crew, particularly of a failure, anomaly or deviation.

➤ **By the manufacturer**

- ❑ Memory item: the following procedures are to be applied without referring to paper.
- ❑ Abnormal or emergency procedures: maintain adequate safety and help to ensure the conduct of the flight. The flight crew uses the "READ and DO" oral reading principle when performing these procedures.
- ❑ Supplementary Techniques: some normal procedures, which are not routine will be found in the SUPPLEMENTARY TECHNIQUES CHAPTER (3.04).

1.17.1.3.2 Method for processing failures and for task-sharing

➤ **By the operator**

Any flight crew member who notes any failure, whether established or developing, must immediately inform the rest of the crew.

The Captain must, before taking any other action, secure the aircraft's flight path and define the task-sharing.

The failure must then be handled according to the following sequence:

- ❑ Confirmation of the type of failure;
- ❑ Application of the check-lists or abnormal procedures and, possibly, re-initialisation of systems;
- ❑ Technical, operational and commercial review;
- ❑ Decision on continuing the flight;
- ❑ Information to: ATC, cabin crew, airline (OCC, maintenance, etc), passengers.

Note: In its method for handling failures, the operator specifies that the Captain defines the task-sharing between the Captain and the copilot, and PF and PNF. The manufacturer however establishes a systematic sharing of tasks between the PF and PNF.

The sharing of tasks is detailed in the TU (Technique Utilisation – technical standards) manual), which stipulates that:

“Via the transmission of information messages and their perfect understanding, cross-checking is an important factor in ensuring the safety of a flight.

For a two-person flight crew, compliance with this principle is essential, especially when implementing urgent or emergency check-lists.

Consequently, any action that has an impact on the flight path or on the status of a system must be called out by the pilot who performs the action and be checked by the other pilot”.

The operator states that *“During the processing of the failure, the PF is responsible for the piloting and navigation functions and monitors the implementation of the check-list.”* And that *“The PNF goes through the check-list and monitors the flight path.”*

The TU manual (technical standards) specifies that:

- ❑ It is always the Captain, irrespective of whether s/he is PF or PNF, who calls for the performance of an emergency manoeuvre by calling out its title;
- ❑ The Captain initiates the urgent and emergency check-lists;
- ❑ The Captain quickly determines the flight path to follow, and which pilot is responsible for doing so, if this has not already been determined during a preliminary briefing;
- ❑ Depending on the circumstances, the Captain may change the pilot flying status by calling out “I have the controls” or “Passing the controls over to you”;
- ❑ If the co-pilot is unable to perform the role of PF, s/he calls out “Passing the controls over to you” and transfers the controls back to the Captain.

➤ **By the manufacturer**

In the manufacturer’s FOBN entitled “Operating Philosophy”, section IV, the manufacturer states that modifications of Airbus’s SOPs by the operator may be coordinated with the manufacturer and that modifications usually require approval from the national authority. It specifies task-sharing based exclusively on the roles of PF and PNF.

The DSAC (France’s civil aviation safety directorate) did not comment on the differences between task-sharing indicated by the manufacturer and that indicated by the operator.

1.17.1.4 Training at Air France

1.17.1.4.1 CRM training

CRM is defined as the utilisation in the cockpit of all available resources: equipment, procedures and people, to ensure the safety and efficiency of flights.

Training in this field is governed by a regulatory framework: the directive of 1st June 2006 (OPS 1.943, OPS 1.945, OPS 1.955) accompanied by a guide and the recommended practices drawn up by the authority.

The aim of CRM is to develop effective cross-checking and support capabilities between the members of the crew. Crews are evaluated using four behavioural indicators: ability to cooperate, management and leadership, situational awareness, and decision-making.

In addition, the ability to cooperate, or work as a team requires that the Captain has effective management and leadership qualities.

Working as a team increases the crew's ability to solve problems in degraded situations. The crew must use resources such as:

- Communication, monitoring and information retrieval skills;
- Technical expertise;
- A willingness to succeed.

Certain organisational or personal factors could adversely affect the operator's CRM performance:

- Company culture;
- The belief that the crew's actions and decisions are correct, even though they deviate from the standards;
- Effects of fatigue and the lack of corrective measures to address the issue and to restore vigilance levels, or
- A certain reticence to accept that CRM issues can play a key role in the occurrence of accidents.

Since 2005, the teaching of CRM at Air France has been subject to change. The airline wanted to integrate more pragmatic concepts (feedback from flight analysis) with the theoretical concepts. Thus, the contract with the original service provider was terminated in favour of the use of internal resources.

The human factors division, in close association with the flight analysis division takes care of instructor training. The type of communication has evolved from a "top-down" style to an "interactive" style that encourages input from flight crew.

The human factors division coordinates the work of about 500 instructors (TRI/TRE, including approximately 80 human factors trainers: 20 flight crew/60 cabin crew). It ensures that their skill levels are maintained (1 day per year).

Human factors trainers are selected, then follow a suitable training programme. TRI are trained in how to observe and record the main aspects of CRM.

➤ **CRM training for crews**

Flight crew attend CRM training at different stages in their careers:

☐ Initial training at Air France

Following their induction into Air France, flight crew attend an initial two-day course: the first day coinciding with type rating, then a second day 6 months after the end of line training. A significant portion of the second day is dedicated to feedback from experience gained from 6 months of line flying. This training covers all of the themes required by the regulations.

☐ Recurrent training at Air France

The key regulatory elements are taught over a three-year cycle.

Recurrent training is done via ground training (S2) and training on simulators. Every year, one half-day of lessons in the flight division, includes common CRM for flight crew and cabin crew and CRM just for flight crew.

During ECP (recurrent training on simulators) twice a year, various CRM themes are covered during the simulator sessions. Non-technical skills (NOTECHS) are evaluated in practical situations.

In parallel, flight crew attend a “company training” course, which complements the regulatory training: modules L0 to L6 (with modules L2 and L3 dedicated to preparation for the Captain module), then a leadership optimisation course (SOC) about two years after starting work as a Captain. At the time of the incident, company training was overseen by the head of the human factors division.

Poor CRM performance by a crew that does not lead to a major technical or operational problem, does not, according to the regulations, lead to a trainee being failed.

There is no regulatory CRM training specific to two co-pilots to prepare them for the role of relief Captain.

➤ **Summary of CRM training courses followed by the crew of AF 447**

The training followed by the crew was standard:

Flight crew	Ground training	Simulator training	Company training
Captain	<ul style="list-style-type: none"> • Initial CRM → 1998 • CRM “AF-Air Inter” merger • ECP “S2” days 	Human factors briefings (ECP sessions Exx)	
CP A (left seat)	<ul style="list-style-type: none"> • Initial CRM → 1998 • ECP “S2” days 	Human factors briefings (ECP sessions Exx)	AL L0 L1
CP B (right seat)	<ul style="list-style-type: none"> • Initial CRM → 2004 “v3” • ECP “S2” days 	Human factors briefings (ECP sessions Exx)	AL L0 L1

1.17.1.4.2 Training in the "IAS douteuse" emergency manoeuvre and "ADR check" procedure

European regulation (EC) n°859/2008 of 20 August 2008 (EU-OPS 1) requires that operators should provide annual training for their crews. This training, consisting of briefings and exercises on a simulator, will include the regulatory exercises and supplementary exercises at the airline's discretion.

Accordingly, Air France had introduced into its 2008/2009 training programme a briefing on airspeed indication anomalies for all flight phases, accompanied by an exercise on a simulator, in climb shortly after take-off.

Note: the « Vol avec IAS Douteuse » exercise took place during the takeoff from Rio. Some Air France pilots stated that during this exercise, no ECAM warning was generated because the ADR's supplied the same erroneous information. The objective of this exercise was to undertake the emergency manoeuvre with the thrust / pitch attitude parameters corresponding to the takeoff phase. The briefing for the exercise was based on:

- The choice between the « IAS douteuse » emergency manoeuvre and the non ECAM check-list « Vol avec IAS Douteuse / ADR Check proc »,
- The conditions for undertaking the emergency manoeuvre,
- Human factors (highly stressful situation, PEQ coordination, in particular).

The operator and the manufacturer indicated that this exercise scenario provided an opportunity to practice the emergency manoeuvre (see appendix 5) and to implement the pitch and thrust values for the climb, level flight and descent phases. Bearing in mind the practical impossibility of training for a procedure in all phases of flight, this scenario was chosen since it was considered to cover the most critical cases (near to the ground with changes of configuration).

Note: In the Flight Crew Training Manual (FCTM) dated January 2005, the manufacturer describes the conditions under which airspeed anomalies occur and the QRH unreliable airspeed/ADR check procedure to be applied by crews that encounter such anomalies.

The Air France training module on the A330 for the instruction season that ran from 1 April 2008 to 31 March 2009 included an « Vol avec IAS Douteuse » exercise. Extracts from the briefings booklet for the A330/A340 Recurrent Training are in appendix 7. The briefings booklet supplements the analytical instruction programme that describes the execution of the exercises and the checks conducted. It is handed out to the pilots on the training course to assist them with their preparation work.

Note: In this briefings booklet, the introduction of the « Vol avec IAS Douteuse » theme mentions the loss of control that follows on from the crew's failure to detect erroneous airspeed indications, on aircraft with traditional flight controls.

Furthermore, the booklet states that, on the Airbus A330, and other than in exceptional circumstances, a failure or erroneous information will be displayed by the ECAM and that the FMGEC computers reject the ADR that provides erroneous speeds/altitudes.

In the exceptional case where two erroneous speeds are not rejected, the flight control and guidance computers use the two incorrect ADR for their calculations. In this case, the crew must:

- Apply the emergency manoeuvre if it considers that the conduct of the flight is dangerously affected (initial climb, pull up);
- Apply the QRH « Vol avec IAS Douteuse » procedure if the flight path has been stabilised and the conduct of the flight has been secured.

This briefing booklet also draws up a list of points that might assist or affect the execution of the emergency manoeuvre, and in particular indicates:

- ❑ That the factors identified as aids are: the ground speeds, GPS altitude, radar altimeter height and STALL warning;
- ❑ That, on the other hand, the following factors could cause confusion and generate stress: unreliability of the FPV and of the vertical speed if the altitude indications are affected, erroneous primary information with no associated message on the ECAM, the presence of alarms (false or proven, e.g. overspeed);
- ❑ That the key points essential for correct management of the situation are: detecting the anomalies, interpreting the alarms and a coordinated approach to handling the situation.

The scenario selected for the simulator exercise required the crew to perform the component items of the emergency manoeuvre in a context in which the aircraft remained in normal law and no alarm was triggered.

Based on the information provided by the operator, the pilots of F-GZCP performed this training session on the following dates:

- ❑ Captain: A330 training on 12 March 2008;
- ❑ Copilot in left seat: A330 training on 6 December 2008;
- ❑ Copilot in right seat: A330 training on 2 February 2009.

It has not been possible to identify any other training in « Vol avec IAS Douteuse » on an A330 or A340 simulator performed by the flight crew.

Note: The research carried out regarding pilot training identified an exercise entitled « Vol avec IAS Douteuse » performed in a simulator by the Captain during his A320 type rating training with Air Inter (refer to section 1.5).

1.17.1.5 Air France's safety management process

1.17.1.5.1 Regulatory provisions

On 1st June 2009, the principal requirements that Air France had to meet in terms of managing flight safety were those set forth in (EC) regulation No. 859/2008 of 20 August 2008 (EU-OPS1). In section 1.037, this regulation requires the introduction of an accident prevention and flight safety programme, involving, notably, an "incident reporting system" and a "flight data analysis programme". The execution of this programme was monitored by the DGAC in the context of its oversight duties.

1.17.1.5.2 Organisation of safety management within Air France

An entity responsible for handling event reports exists within each Air France operational division, and notably within those relating to Air Operations and Maintenance. The work of these various entities is coordinated by a department whose level in the organisational hierarchy is the same as the executive board responsible for operations.

Within the Air Operations division, Flight Safety Officers (OSV) relay safety information to the flight crew working in each sector (top-down distribution of information) and to the Accident Prevention and Flight Analysis department. In terms of their operational

duties, the OSV report to the accident prevention and flight safety department, and in respect of these duties are independent of the management hierarchy of the sectors in which they work.

Air France has set up a system for reporting information consisting of a number of different reporting pathways, with the main ones being: mandatory reports (ASR for flight crew), volunteered and anonymous reports, the systematic analysis of flight data and technical events occurring in flight.

Note: The systematic analysis of flight data involves examining the data recorded for various parameters selected by the operator and identifying any incidences of pre-determined thresholds being exceeded. At Air France, an internal protocol, agreed in 1974 with the professional bodies, defines how the results are analysed. One of the guarantees provided by this protocol is the particular conditions that must be satisfied before lifting anonymity and the impossibility of using flight data to monitor the performance of individual crew members.

Events considered as significant are raised during weekly meetings (RX2) attended by flight safety representatives responsible for handling event reports in each of the sectors. Depending on the issue identified, the way in which it is dealt with varies, and can include:

- ❑ Short-term procedures that involve a single sector only. These procedures address events selected in meetings that require additional information and possibly a one-off action monitored within the sector identified;
- ❑ Internal investigations conducted by a department and that may require a multi-disciplinary approach. The investigation may be straightforward or in-depth, and its report may contain an analysis and recommendations for corrective and preventive actions. These investigations take between 1 and 3 months to complete.

Alternatively, each department may decide to adopt a particular approach to following-up the issue in order to collect information, determine the mid- to long-term corrective actions (to address a common theme) and integrate any new events.

All active follow-up initiatives remain on the agenda of RX2 meetings and are discussed by the representative from the various sectors.

In addition to the corrective and preventive actions applied, e.g. changes to a procedure, equipment or to a training programme, the various initiatives implemented to address the events more systematically result in raising awareness or providing personnel with more information. To this end, several communication aids are used such as publications or presentations at training sessions. The departments primarily responsible for issuing these publications are Engineering, Accident Prevention and Flight Analysis.

1.17.1.5.3 Processing of incidents involving inconsistencies in indicated airspeeds

1.17.1.5.3.1 Detection and characterisation of the incidents

Between May 2008 and March 2009, for Air France's A330/A340 fleet, nine incidents appeared in the ASR associated with unreliable indicated airspeeds: one in May 2008, one in July 2008, three in August 2008, one in September 2008, one in October 2008, and two in March 2009.

All occurred in cruise between FL310 and FL380. In seven cases, the ASR mentioned the activation of the stall warning. Two of the nine Captains who submitted an ASR indicated in the "Suggestions" box, in the margin of their report, the potentially detrimental or destabilising nature of this failure, considered as multiple, notably because of the requirement to analyse and make sense of the situation encountered.

These incidents were raised during the RX2 meetings. The processing of the issues raised is described below.

Note: After the accident, Air France carried out a focused analysis of the recorded flight parameters and identified six additional incidents which had not been raised in an ASR. The reports intended for maintenance (ATL) drawn up by the Captains to describe these incidents do not, or only partially, indicate the characteristic symptoms of the incidents associated with unreliable indicated airspeed.

1.17.1.5.3.2 Processing by the department responsible for maintaining aircraft

During this period, most of the actions relating to the problem of unreliable indicated airspeed were attributed to the division responsible for maintaining Airbus's long-haul aircraft. The nature of these actions was additional information about each of the events. This information was presented during a subsequent meeting.

Special monitoring was set up within this department to determine the corrective actions to be implemented. This monitoring was discussed during numerous exchanges with Airbus. A summary of these exchanges and of the actions concerned is presented below (a history of the probes is presented in section 1.18.1.7).

Note: Air France received its first A330s in December 2001. They were originally equipped with Thales C16195AA probes. Following the publication of the 2007 Service Bulletin, and in the absence of problems of this type affecting its long-haul fleet, Air France decided to replace the Pitot C16195AA probes, but only in the event of a failure, with Pitot C16195BA probes.

The first event involving a temporary loss of airspeed indication at high altitude occurred in May 2008.

Starting in July 2008, Air France reported these events to Airbus, in compliance with SIL 34-084 published by Airbus "Unreliable airspeed indication – Pitot probes maintenance action".

On 24 September and 6 October 2008, Air France asked Airbus for information about the cause of these events and the solutions to implement, and also asked if the Thales C16195BA probe could resolve these problems. Airbus replied that the cause of the problem was probably probe obstruction by a rapid accumulation of ice crystals, and that the Thales C16195BA, developed to address the issue of water ingestion during heavy rainfall, was unlikely to improve the performance in an ice crystal environment. Airbus stated that there was no solution that could totally eliminate the risk of probe icing, that the three types of probe installed on the Airbus satisfy criteria that are much higher than the regulatory requirements for certification in relation to icing, and provided a reminder of the procedure to be applied in the event of an erroneous airspeed event.

From October 2008 onwards, Air France alerted Thales about the increasing problem of icing at high altitude. Thales started an internal procedure to perform a technical analysis of these incidents.

On 24 November 2008, the issue of inconsistent airspeed indications was raised during a meeting between the technical divisions of Air France and Airbus. Air France requested an analysis of the root cause and a technical solution to resolve this problem, and suggested that BF Goodrich probes should be fitted, since their reliability appeared to be greater. Airbus confirmed its analysis and agreed to check the option of replacing the Thales probes with BF Goodrich probes. This point was followed by Air France and Airbus via the implementation of a “dashboard of indicators” approach.

At the end of March 2009, Air France experienced two further events involving the temporary loss of airspeed indication, including the first event on an A330.

On 3 April 2009, in light of these two new cases, Air France once again asked Airbus during a technical meeting to find a definitive solution.

On 15 April 2009, Airbus informed Air France of the results of a study conducted by Thales. Airbus stated that the icing phenomenon involving ice crystals was a new phenomenon that was not considered in the development of the Thales C16195BA probe, but that the latter appeared to offer significantly better performance in relation to unreliable airspeed indications at high altitude. Airbus offered Air France an “in-service evaluation” of the C16195BA standard to check the behaviour of the probe under actual conditions.

Air France decided to extend this measure immediately to its entire A330/A340 long-haul fleet, and to replace all the airspeed probes. An internal technical document was drawn up to introduce these changes on 27 April 2009. The modification work on the aircraft was scheduled to begin as soon as the parts were received. On 19 May 2009, based on this decision, the monitoring of these incidents was considered as closed during the RX2 meeting. The first batch of Pitot C16195BA probes arrived at Air France on 26 May 2009, i.e. six days before F-GZCP crashed. The first aircraft was modified on 30 May 2009.

At the time of the accident, F-GZCP was fitted with the original C16195AA probes.

1.17.1.5.3.3 Processing by the air operations departments

The department responsible for drawing up the operational reference documents (NT) participated in the RX2 meetings and queried certain elements of the “unreliable indicated airspeed” procedure in relation to the circumstances of the incidents recorded. Airbus was asked to respond to these queries on 24 September 2008. Airbus confirmed its position by recommending that the « Vol avec IAS Douteuse” procedure should be followed, but clarifying that the memory items should only be applied in situations in which safety is compromised, which was not the case in cruise.

Other operators were consulted by the NT department on 24 April 2009 on an Airbus forum reserved for operators. Prompt action from Airbus was requested. Airbus replied on 14 May 2009 during a conference dedicated to the points raised on this forum. They reiterated the causes and described the improvement offered by the Thales C16195BA probe. Furthermore, they provided a series of recommendations and associated references relating to the applicability of the unreliable indicated airspeed procedure, training (regarding the crew’s reaction at high altitude and the unreliable indicated airspeed procedure) and the avoidance of zones conducive to the ice crystals phenomenon. This presentation mentioned the on-going discussions focused on optimising the drafting of the procedure.

The assessment of the impact of these incidents on operational safety, performed by the department responsible for accident prevention and flight safety during this period, was not documented in full or formalised. It was explained that:

- Every anomalous airspeed was subject to analysis and monitoring (study of the crews' reports, classification of the ASR, monitoring non-standard flight parameters by analysing recorded flight data) by the service responsible for accident prevention and flight safety. This analysis was shared with the other departments during the RX2 meeting;
- This service undertook specific analysis of the recorded parameters recorded for certain incidents. This analysis was prompted on some occasions by a request from a crew that then had access to the parameters. A specific check was performed to ensure that there was no loss of control of the flight path;

Note: A summary document characterising the incidents identified by Air France and submitted to the BEA shortly after the accident reveals that the pitch attitude during these incidents varied from -3 to 7 degrees; and that the maximum angle of attack was 13 degrees.

- The flight safety officer (OSV) for A330/A340, who reports to this department, interviewed most of the pilots who reported these incidents. The accounts given by these pilots did not suggest an immediate risk. The Head of the Division, the Head of the Technical Information Office and the Head of Professional Standards for the A330/340 division also interviewed certain crew members.

Based on this information, during the autumn of 2008, Air France considered that flight safety was not immediately affected by this type of incident.

The training programme for the 2008-2009 season included an exercise that required the « Vol avec IAS Douteuse » procedure to be applied at take-off. Its integration in 2007 was prompted by the incidents caused by the ingestion of water on A320 aircraft. The exercise was considered as representative of the main difficulties linked with its application during the various flight phases.

Four ASRs relating to these incidents were published during this period in several issues of the "Sûrvol" flight safety bulletin, circulated to all flight crew.

On 6 November 2008, information about the anemometric anomalies that had occurred in cruise and that affected the A330/A340 fleet was circulated within Air France to the pilots working in the sector. The "info OSV" document indicated that six events of this type were reported in crew reports (see appendix 8).

It states that the incidents are characterised by losses of anemometric indication, numerous ECAM messages and in some cases configuration alarms. The events occurred at high altitude in turbulence, in zones in which icing was forecast or observed, for aircraft flying at a Mach of 0.80 to 0.82 with autopilot and autothrust engaged. The chronology of the anomalies is described. It states that "during this phase, which lasted for approximately a few minutes, the crews did not report any feeling of overspeed (vibration, acceleration) or the approach to stall (pitch attitude, angle of attack, reference to the horizon) despite the activation of the stall warning". Four general recommendations were circulated to crews. The "vol avec IAS douteuse" procedure and the conditions for its application were not repeated.

1.17.1.5.4 Air France internal flight safety reports

A Flight Safety report was made in 2006 by an airline internal commission following incidents and accidents, in particular the Air France accident at Toronto in August 2005. The commission studied events at the airline that had occurred between 1985 and 2006. Notable elements from the report identified:

- ❑ During the period in question, two-thirds of the events occurred on long-haul flights;
- ❑ The “situational awareness”, “decision-making” and “crew synergy” causal factors were inseparable and constituted by far the most significant contributing factor;
- ❑ Piloting abilities of long-haul and/or ab initio pilots are sometimes weak;
- ❑ A loss of common sense and general aeronautical knowledge were highly noticeable;
- ❑ Weaknesses in terms of representation and awareness of the situation during system failures (reality, seriousness, induced effects).

In the observations and conclusions that the commission reached, it was noted:

- ❑ In analyzing the main causal factors in serious events and fuel-related incidents, the commission observed that human factors (situational awareness, synergy, decision-making) were factors found in 8 out of 10 events, far ahead of those involving organisation, environment and technical factors), even if such factors should not be ignored as contributory;
- ❑ Significant weaknesses in terms of training, real concrete appropriation and ability to evaluate, of these human factors, were observed in the flight crew population and indeed among all those whose actions and decisions had direct consequences on flight safety;
- ❑ These weaknesses in relation to transverse functioning – synergy in CRM language – made it impossible for the company to have a clear and objective view of its performances in terms of aviation safety and propose concrete and appropriate solutions within a reasonable time period.

Following this report, Air France put in place several measures, including:

- ❑ creation of the risk prevention and quality assurance management;
- ❑ Fundamental work on restructuring “Operational Procedures”;
- ❑ Restructuring of the content of training courses;
- ❑ Setting up of several working groups on human factors, specifically for type rating, ECP, training and recruitment of instructors, CRM training of pilots and line checks;
- ❑ Evaluations of the professional levels of flight crew.

1.17.2 Organisation of oversight of the operator by the DGAC

1.17.2.1 The French Civil Aviation Safety Department (DSAC)

The DSAC-NO (Airworthiness and Operations division of France’s civil aviation safety directorate) is responsible for carrying out the continued oversight of Air France. This oversight ensures that the conditions are maintained for issue of the AOC, as described in Regulation 3922-91, known as EU-OPS.

This obligation stems from the following documents that establish the legal framework for the execution of oversight operations:

- ❑ ICAO document Doc.8335: *Manual of procedures for Operations Inspection, Certification and Continuing Surveillance – Chapter 9,*
- ❑ *JAA Administrative and Guidance Material (JIP) – Part 2 OPS Procedures – Chapter 5.*

The oversight work in the area of aviation operations⁽¹³⁾ is primarily ensured by:

- ❑ Performing scheduled checks covering the 12 technical domains⁽¹⁴⁾ defined in the JIPs- over a 24-month cycle;
- ❑ Performing unannounced checks in flight or on the ground (at the operator's premises, during a stop-over, on an aircraft) The in-flight or simulator checks, whether programmed or unannounced, are undertaken by pilots from the PEPN or the OCV.

Each technical domain is checked by one or more specialists acting on behalf of an inspector with special responsibility for a given operator. The methods for checking these domains are defined by the DSAC in its Manuel du Contrôle Technique (MCT) (technical inspection manual) used by all the French regional oversight authorities (DSAC-IR). About 70 people are involved in this oversight activity within the DSAC and the Organisme du Contrôle en Vol (OCV) (flight control organisation).

DSAC-NO managers have stated that on average the oversight of Air France represents about 8,000 hours of work a year and requires the equivalent of 5 full-time inspectors, shared between 15 people, without counting in-flight checks.

The Pôle d'Expertise du Personnel Navigant (PEPN) (flight crew expertise centre) is responsible for carrying out the scheduled in-flight and simulator checks. The 7 expert pilots employed by the PEPN conducted about 60 checks in 2009, of which 5 at Air France.

All these checks performed by the DSAC relate to regulatory compliance. Consequently, the oversight activity is exclusively concerned with checking that the organisation set up by the operator complies with the regulatory requirements stated in the EU-OPS and by the FCL.

Through in-flight checks, PEPN and the OCV conduct qualitative evaluations intended to identify, through observing the work of a crew, any safety-related deficiencies in the operator's organisation. The PEPN managers stated that these evaluations must be analysed by the DSAC-NO in order to identify and notify any deviations from the regulations resulting from elements noted in the course of these checks.

Through checks on compliance with the regulations, the DSAC's oversight work does not involve the systematic analysis of any differences that may exist between the procedures implemented by a manufacturer and by an operator. However, in case of a significant difference whose justification does not seem obvious, the DSAC can ask the operator to justify the reasoning behind its choice. Oversight makes it possible to check that these procedures are properly documented in the operator's Operations Manual. It does not constitute an analysis of the operator's procedures, working methods, or training.

⁽¹³⁾Outside of oversight of maintenance and training associated with pilots' licences.

⁽¹⁴⁾Infrastructure, Manuals, Training, Crew records, Maintenance, Ramp Inspection, Equipment, Release of Flight/Dispatch, Flight Inspection, Navigation (Ground) inspection, Dangerous Goods, Operator's Quality System.

Within the DSAC, the « State public transport safety programme » division of the « safety evaluation and improvement mission » (DSAC/MEAS):

- ❑ Coordinates and checks the implementation of the State safety programme (PSE) for public transport, in liaison with the BEA and all of the services involved at the DGAC. To do this it analyzes the level of safety in public transport, defines and follows safety indicators;
- ❑ Sets up an event reporting system and ensures follow-up of incidents, in particular through the ECCAIRS database;
- ❑ Puts in place periodic safety reviews and implements the conclusions of these reviews;
- ❑ Pilots studies relating to the safety of public transport.

The safety evaluation and improvement mission (MEAS) receives around 7,000 ASR from Air France (+ 52 RX2). The content of the ASRs does not always make it possible to evaluate the seriousness of an event. Many are detected only by flight analysis after the event.

There are 106 French companies holding an AOC. In 2009, they made over 700,000 flights, more than half of them being made by Air France.

1.17.2.2 In-flight inspection organisation (OCV)

This organisation acts as technical adviser to the Director General of Civil Aviation to whom it reports directly. In addition, it undertakes the following missions:

- ❑ It responds directly to requests from the DSAC;
- ❑ It undertakes unscheduled checks, where necessary in coordination with the inspection missions decided on by DSAC/NO;
- ❑ It can be required directly by the PEPN, in relation with the DSAC, to undertake checks in flight or simulator.

The OCV has 12 inspectors (all Captains) who share their time between the airline and the DSAC, thus the equivalent of about 6 full-time for the DGAC.

Following an inspection, the inspector writes a report that can give rise to comments. These comments must be analyzed by the DSAC in order to identify and notify any deviations from the regulations.

In 2009, the OCV undertook 310 inspections including 88 at Air France on both the medium and long haul network.

At the time of the accident, none of the in-flight checks had given rise to any notifications to Air France.

1.17.2.3 Inspection of DSAC standardisation by EASA

In September 2009, EASA undertook an inspection of the DSAC. It should be noted that this inspection was programmed in March 2009 in the context of an inspection schedule and was thus not linked to the AF 447 accident. However, this inspection was an accurate reflection of the situation of the oversight authority at the time of the accident.

This inspection led to the notification of 7 comments relating to:

- ❑ the role of the OCV whose unscheduled inspection activity was not fully integrated into the DSAC's continued oversight system;
- ❑ lack of initial and recurrent training for some in-flight and ground operations inspectors;
- ❑ a lack of experience in the area of aviation operations for some inspectors, which could affect their judgement and their credibility vis-à-vis the operators' personnel.

1.17.3 Air traffic services for a trans-oceanic flight

ICAO document 4444 states in chapter 4 that air traffic services undertake control, information and alert services. Each ICAO Contracting State integrates this document into its regulations.

1.17.3.1 Brazilian air traffic control organisations

The Brazilian air traffic control system (SISCECAB) comprises a central entity (DECEA) and air navigation service providers such as CINDACTA (integrated air defence and air traffic control centre), SRPV-SP (regional flight protection service) and INFRAERO.

On the day of the accident, the ATLANTICO ACC controller did not ask the crew of flight AF 447 to contact the controller of DAKAR Oceanic ACC five minutes before reaching the TASIL waypoint. The DAKAR Oceanic ACC controller did not contact the ATLANTICO ACC controller to inform him that no contact had been made with the crew of flight AF 447 three minutes after the estimated time at which it passed the TASIL waypoint.

Document AIRAC AIP SUPPLEMENT SUP A065-074/08, dated 25 September 2008, which came into force on 23 October, describes the deployment of ADS-C within the ATLANTICO FIR. This document does not mention the experimental nature of this deployment. It specifies that the position reports must be accomplished by voice communication on HF, when the ADS-C system is not available..

Flight AF 447 had not established an ADS contract. The CPDLC service was not in effect in the ATLANTICO FIR on the day of the accident.

1.17.3.2 Senegalese air traffic control organisations

Overseas flights are controlled in accordance with procedures. In the absence of a flight plan filed in the Eurocat system, coordination between the ATLANTICO and DAKAR Oceanic controllers allowed the latter to edit the strip chart shown below.

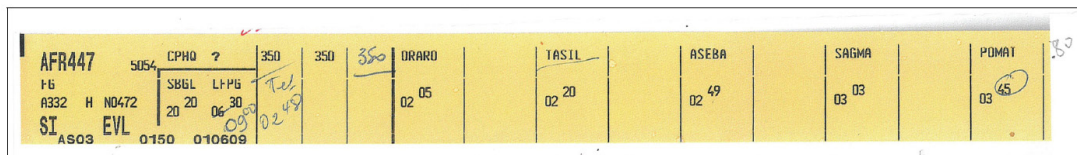

Figure 86: Strip created after coordination between ATLANTICO and DAKAR Océanic

This strip chart indicates the estimated times at which the aircraft would arrive in the FIR (TASIL 2h 20 min) and leave the FIR (POMAT 3h 45 min) based on the

aircraft's speed.

1.17.4 Search and Rescue (SAR)

The purpose of an SAR service is to search with maximum efficacy for persons in distress in peacetime and to rescue human lives on land and at sea.

Global SAR plans include:

- The IMO's SAR plan for the maritime domain;
- ICAO Regional Air Navigation Plans (RANP) for the aeronautical domain.

These global plans stem from the IMO's SAR convention and from annex 12 of the convention on civil aviation. They constitute the basis for the deployment of national and regional plans, manuals, agreements and the associated SAR documents.

The Air Navigation Plans issued by ICAO indicate, for every region in the world, the boundaries of the various aeronautical SRR's. These areas may be the same as the FIR of the Contracting States. For every SRR there is an air rescue coordination centre (ARCC).

The IMO's SAR plan presents the world-wide arrangement of maritime SRR. Every SRR has at least one maritime search and rescue coordination centre (MRCC).

It should be noted that the boundaries of maritime SRR are often different from those of aeronautical SRR.

Oceanic zones may be covered by an RCC associated with more than one State.

1.17.4.1 Documentary references

➤ ICAO Annex 12: Search and Rescue

Annex 12 is exclusively concerned with search and rescue in the aeronautical domain. It applies to the establishment, maintenance and operation of search and rescues services by Contracting States in their territories and over the high seas, in addition to the coordination of these services between neighbouring States.

Annex 12 is complemented by the international aeronautical and maritime search and rescue (IAMSAR) manual.

Annex 12 specifically states that:

Contracting States shall, individually or in cooperation with other States, take all measures necessary to arrange for the establishment and prompt provision of search and rescue services to ensure that assistance is rendered to all persons in distress.

Those portions of airspace located above the high seas or areas of undetermined sovereignty [...] shall be determined on the basis of regional air navigation agreements.

Contracting States should ensure the closest practicable coordination between the relevant aeronautical and maritime authorities to provide for the most effective and efficient search and rescue services.

Particularly, annex 12 recommends that:

Contracting States should, in so far as practicable, develop search and rescue plans

and procedures to facilitate coordination of search and rescue operations with those of neighbouring States.

Contracting States should establish joint rescue coordination centres to coordinate aeronautical and maritime search and rescue operations, where practical.

Any authority or any element of the search and rescue organization having reason to believe that an aircraft is in an emergency shall give immediately all available information to the rescue coordination centre concerned.

When information concerning an aircraft in an emergency situation is received from other sources than air traffic organisations, the rescue coordination centre shall determine to which emergency phase the situation corresponds and shall apply the procedures applicable to that phase.

In the event that an emergency phase is declared in respect of an aircraft whose position is unknown and which may be in one of two or more search and rescue regions, the rescue coordination centre that is notified of the existence of an emergency phase for which, as far as it is aware, no other centre has taken appropriate action, shall assume responsibility for initiating suitable action (i.e. the actions corresponding to the emergency phases) and shall confer with neighbouring rescue coordination centres with the objective of designating one rescue coordination centre to assume responsibility forthwith for the operations.

Unless otherwise decided by common agreement of the rescue coordination centres concerned, the rescue coordination centre that shall coordinate search and rescue action shall be the centre responsible for:

- The region in which the aircraft last reported its position, or;*
- The region to which the aircraft was proceeding, when its last reported position was on the line separating two search and rescue regions, or;*
- The region to which the aircraft was destined if it was not equipped with suitable two-way radio communication or was not under obligation to maintain radio communication, or;*
- The region in which the distress site is located as identified by the Cospas-Sarsat system.*

➤ **The IAMSAR (International Aeronautical and Maritime Search and Rescue) manual**

The primary purpose of the IAMSAR manual is to assist States in meeting their own search and rescue needs and the obligations they accepted under the Convention on International Civil Aviation, the International Convention on Maritime Search and Rescue, and the International Convention for the Safety of Life at Sea (SOLAS). It provides guidelines for a common aviation and maritime approach to organising and providing SAR services. States are encouraged to develop and improve their SAR services, to cooperate with neighbouring States and to consider their SAR services to form part of a global SAR system.

➤ **ICAO Annex 11: Air Traffic Services**

Annex 11 governs the application of air navigation services procedures. Chapter 5 is concerned with the alerting service and particularly describes its operation and the alerting of the relevant organisations (notably RCC and rescue operation centres).

The alerting service is provided by air traffic control organisations. The actions they take depend on the urgency of the situation, as defined by the “alert phase”:

- ❑ Uncertainty phase, *incerfa*: this phase is notably established when no communication has been received from the crew within a period of 30 minutes after the time a communication should have been received;
- ❑ Alert phase, *alerfa*: this phase is notably established following the uncertainty phase, when subsequent attempts to contact the crew or inquiries to other relevant sources have failed to reveal any information about the aircraft;
- ❑ Distress phase, *detresfa*: this phase is notably established following the alert phase when further more widespread inquiries have failed to provide any information, or when the fuel on board is considered to be exhausted. This phase may also be established when information is received which indicates that the operating efficiency of the aircraft has been impaired to the extent that a forced landing is likely.

These phases are intended for the search and rescue services, which must take appropriate measures, and notify the air traffic control organisations involved with the flight.

1.17.4.2 Implementation of SAR

Search and rescue operations are activated at the initiative of the SAR services (Annex 12) or after an emergency is declared by the air traffic services (Annex 11) or by a third party (Annex 12).

When the probable accident zone extends over both land and sea, each of the centres responsible for searching on land or at sea preserves its allocated responsibilities. However, to ensure that one body takes overall control of the operations, the head of the competent ARCC is in charge of the overall coordination of the operations.

1.17.4.3 Case of an aircraft lost at sea

Air rescue coordination centres (ARCC) are responsible for the search and rescue operations prompted by an air accident. Whenever there is a possibility of an aircraft crash at sea in the SRR covered by an ARCC, the latter can mobilise the search and rescue resources usually dedicated within this zone to the competent MRCC. It is also possible to delegate to the MRCC the search operations for an aircraft that has crashed into the sea.

When the presumed accident zone extends over several search and rescue areas⁽¹⁵⁾, the first RCC to receive notification of an emergency phase takes responsibility for coordinating with its neighbouring centres to identify the centre which will assume the responsibility for conducting and coordinating the search and rescue operations. By default it assumes this function.

⁽¹⁵⁾These zones may extend over several States.

Note: Air-based search resources are frequently military resources. Their mobilisation may thus also involve military decision-making bodies.

1.17.4.4 SAR organisation in Brazil

The route envisaged in the flight plan for AF 447 passed through the FIRs adjacent to Recife ATLANTICO (Brazil) and DAKAR Oceanic (Senegal). Accordingly, Brazil and Senegal are considered as neighbouring States.

The Recife ATLANTICO FIR has an ARCC located at Recife and several MRCC, including one at Natal, and is competent for the zone in which AF 447 crashed. There is no JRCC in the Recife ATLANTICO FIR. ARCC and MRCC are managed by the Brazilian armed forces.

1.17.4.5 SAR organisation in Senegal

The DAKAR Oceanic FIR has an ARCC located in DAKAR, managed by the Senegalese armed forces.

For the purposes of their SAR operations, the Senegalese authorities operate a Bréguet Atlantique aircraft, provided by France in accordance with a protocol signed in 1966. This aircraft is equipped so that it can conduct search operations at night.

No regional SAR coordination plan exists between Brazil and Senegal. Consequently, there is no procedure for enquiring about the SAR resources available to each State.

1.17.4.6 SAR organisation in France

1.17.4.6.1 Aeronautical SAR

Metropolitan France is divided into 4 SRR zones, each of which has its own ARCC.

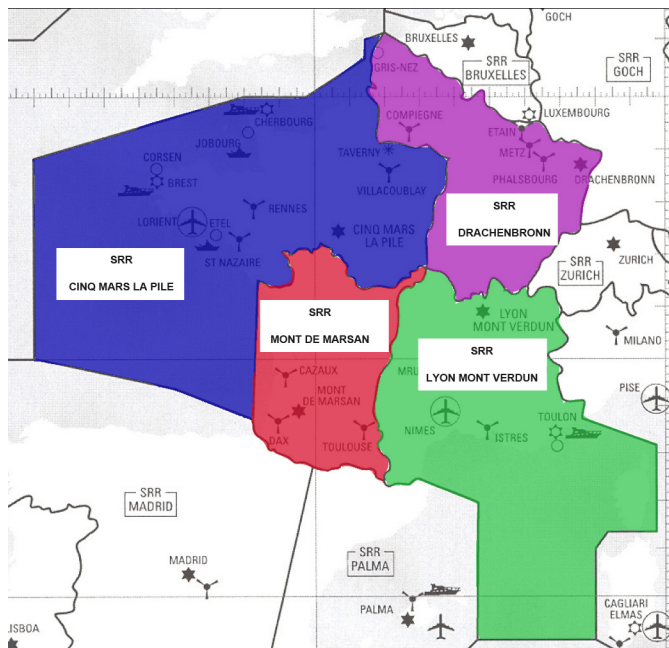

Figure 87: Arrangement of the SRR in metropolitan France

FIR	BREST	PARIS	REIMS	MARSEILLE	BORDEAUX
SRR	Associated ARCC: CINQ-MARS-LA-PILE		Associated ARCC: DRACHENBRON	Associated ARCC: LYON MONT VERDUN	Associated ARCC: MONT DE MARSAN

The French civil aviation directorate (DGAC), responsible for the overall search and rescue policy for aircraft in distress, works closely with the French air force.

No single ARCC is formally designated as the contact point for non-French authorities. In practice, the Cinq-Mars-La-Pile ARCC responds to distress beacon transmissions detected by the Toulouse FMCC.

1.17.4.6.2 Maritime SAR

There are five maritime SAR for which Metropolitan France is responsibility, with a regional operational centre for surveillance and rescue (CROSS) in charge of each area, which performs the role of an MRCC.

Gris Nez MRCC is designated as the SAR point of contact (SPOC) for non-French organisations, and in this capacity can answer any queries relating to the operational aspects of the maritime SARs. Gris Nez MRCC has also been designated as the point of contact for the Toulouse FMCC with regards to the detection of transmissions from distress beacons.

Note: The roles of an SPOC include:

- Assuming default coordination responsibilities,
- Being the point of contact for SAR organisations.
- Making national resources available for the benefit of the competent MRCC,
- Being the point of contact for any French ship anywhere in the world,
- Setting up SAR coordination plan with its non-French counterparts.

1.17.4.6.3 Operational practices and staff training for ARCC and MRCC

1.17.4.6.3.1 ARCC

Practices

Senior staff at Aeronautical SAR centres in France informed the BEA that the ARCCs have only limited communication resources. They are generally equipped with:

- Contact details for adjacent ARCC and for all French ARCC and MRCC;
- Contact details for adjacent air traffic control centres;
- A PC connected to the Internet.

The French ARCCs are not equipped with an Admiralty List-type document (see below) for contacting an ARCC or MRCC anywhere in the world.

Moreover, these senior staff members indicated that their zone of responsibility was restricted by regulations and that outside these zones they were not competent to send or coordinate resources.

Personnel training

ARCC personnel are military personnel from the French air force. Accordingly, their assignment to an ARCC is temporary. During their initial training, all trainees attend an initial one-week training course within the SAR service.

Before commencing their duties, the trainees attend a theoretical and practical training course provided by the air force.

The theoretical training comprises, for some trainees, a 15-day course at the ENAC (national civil aviation university) entitled "SAR service training". It should however be noted that the number of places offered is limited, and that not all ARCC personnel are able to attend this course.

All personnel attend an initial three-week to 1-month theoretical training course within the ARCC to which they are assigned. During this training, personnel study the reference documents, the procedures specific to their ARCC and receive instruction regarding the operation of air traffic control centres (CRNA), the Cospas-Sarsat centre and MRCC.

The in-service training comprises a familiarisation period of about one month within the ARCC to which they are assigned, shadowing experienced members of personnel.

A simulated SAR exercise is used to validate this training.

1.17.4.6.3.2 MRCC

Practices

Note that France's geography and its seafaring activity generates a sustained workload for the MRCC.

So that it can coordinate with other MRCC in France and throughout the world, each centre can refer to a document called the Admiralty List. This document lists the contact details for all ARCC, MRCC and JRCC around the world. Moreover, it indicates, for each country, the reference RCC that acts as the SAR point of contact (SPOC) for foreign organisations.

This document, published by the United Kingdom Hydrographical Office (which transcribed the IMO document – circular SAR 8), is used once an emergency phase has been triggered to identify and contact the MRCC that coordinate the search operations.

Senior members of staff at MRCC have informed the BEA that any doubt regarding a potential emergency situation is investigated by implementing a dedicated process and by collecting information so that it can identify a suitable competent MRCC to coordinate the search. In this context, the MRCCs' actions are not limited by a geographical zone.

Personnel training

MRCC officers are drawn from the French navy and from Maritime Affairs (a governmental department). They are employed as Rescue Mission Coordinators (CMS).

They attend a five-week theoretical training course (CMS module) at the Nantes maritime affairs college. This theoretical training is supplemented by:

- In-service training lasting for about 1 month within the MRCC to which they are assigned
- 15 days of training to obtain the General Operator's Certificate (CGO).

An internal assessment certifies the ability of the officer to perform the duties of a CMS.

1.17.4.7 Audits conducted by ICAO

1.17.4.7.1 Final report on the safety oversight audit of the civil aviation system of France

An audit was conducted in France, in accordance with ICAO directives, from 3 to 23 June 2008.

With regards to air navigation services, its findings were:

“Although the legal framework established by France in the field of national SAR services ensures that close coordination is provided between the competent aeronautical and maritime authorities for maximum efficacy in the conduct of SAR services, France has not established joint RCC to coordinate aeronautical and maritime SAR operations. Furthermore, France has signed letters of agreement with certain neighbouring States, including Spain, Italy, Germany and Belgium regarding the coordination of SAR services, however, the letters of agreement with the other States adjacent to metropolitan France and to its overseas departments and territories have not yet been drawn up and signed”.

1.17.4.7.2 Final report on the safety oversight audit of the civil aviation system of Senegal

An audit was conducted in Senegal, in accordance with ICAO directives, from 12 to 14 June 2006.

With regards to air navigation services, the audit notably proposed that:

- A JRCC should be set up to consolidate the activities of the ARCC and MRCC;
- Cooperation agreements should be agreed with neighbouring States.

At the time of the accident, these recommendations had not been followed up.

1.18 Additional Information

1.18.1 Type Certification and continuing airworthiness

1.18.1.1 Regulatory aspects

The A330 meets the requirements of the regulations in force – that is to say JAR 25 changes 13 or 14 and the special conditions imposed by DGAC – at the time the type certification application was made.

The equipment is developed in compliance with the regulatory requirements defined in JAR 25 part F and, in particular, paragraphs JAR 25.1301, 1309, 1323 (d) (e), 1326, 1419 and in the corresponding ACJs (acceptable but not mandatory means of compliance).

These requirements indicate in particular how this equipment must be designed, installed and tested to verify it can ensure its function in all foreseeable operational conditions.

Among other things, they state that:

- The systems must be developed in such a way that failures that would prevent the flight from being pursued in complete safety are extremely unlikely. Compliance with this requirement must be demonstrated by means of analysis, and flight and ground tests, taking into account the possible failure modes, their probability as well as their consequences on the aircraft and its occupants;

- ❑ The systems and associated warnings must be developed while minimising the risks of crew error;
- ❑ Means of information must be put in place in order to alert the crew of the occurrence of a failure and allow them to take the appropriate measures.

It is necessary to perform an analysis of the criticality of the failures and to associate it to a probability of occurrence (ACJ 25.1309).

This analysis is either undertaken systematically or when necessary by test crews during an aeroplane flight or on the simulator. It involves evaluating the associated work load for crew members in identifying the failure, searching for it and applying the appropriate procedure(s) and/or within the piloting task.

Some paragraphs of the basic regulation (JAR 25 / CS 25) can be modified or completed by special conditions, and this body of rules apply to an aeroplane that is functioning nominally. The cases of failures are covered in paragraph 25.1309.

For the Pitot probes, the regulations also require that:

- ❑ They must be protected against humidity, dirt and other substances that could alter their function (JAR 25.1323 (d));
- ❑ They must be fitted with a heating system designed to prevent any malfunctioning due to icing (JAR 25.1323 (e));
- ❑ Appropriate means must be provided (visual warning directly visible to the crew) to inform the crew of any non-functioning of the heating system (JAR 25 1326);
- ❑ They should be protected against the icing defined in appendix C of JAR 25 (see JAR 25 1419).

➤ **Appendix C of JAR 25 regulation**

Appendix C of JAR 25 is the certification standard in super-cooled water icing conditions for validating the anti-icing protection systems on aircraft. The conditions are defined according to the altitude and temperature in terms of water concentration and of the droplets' mean volume diameters.

Two icing envelopes are defined:

- ❑ The "continuous maximum" envelope corresponding to an average cloud 17.4 nautical miles long, with low water concentrations, rising up to 22,000 feet and with a temperature as low as - 30°C;
- ❑ The "intermittent maximum" envelope corresponding to an average cloud 2.6 nautical miles long, with high water concentrations, with values up to 30,000 ft and - 40 °C.

1.18.1.2 Notions of type certificate and airworthiness certificate

The certification principles require that a generic product (type of aircraft for example) must first of all be certified. When the product has successfully completed the certification process, a "type certificate" is issued by the authority to the company that designed the product. This certificate states that the generic product meets the applicable technical conditions in every aspect.

An individual airworthiness certificate is then issued for each product (aircraft for example) after it has been demonstrated that it conforms to the certified type.

Among other things the holder of a type certificate is obliged to ensure the continuing airworthiness of its fleet.

At the time of the issuance of the first type certificate for the A330, the DGAC was the authority responsible for issuing certificates to Airbus. The certification principles, based on the JAR 21 regulations developed by the JAA were similar to those defined today in part 21.

In particular, in accordance with JAR 21, the decree dated 18 June 1991 put in place a design approval procedure for the manufacturers of aeronautical products and determined the conditions that must be met by approved manufacturers. This approval – called DOA (Design Organization Approval) – obliges the manufacturer to give details of the working procedures that it will put in place to meet the requirements of JAR 21 or of part 21, in particular in relation to continuing airworthiness.

1.18.1.3 Continuing airworthiness

Continuing airworthiness rests in particular on the evaluation of the criticality of occurrences, classified during type certification according to four levels (in accordance with AMJ 25.1309): minor, major, critical and catastrophic. The certification regulations associate an acceptable probability to each of these levels.

Continuing airworthiness is in fact ensured both by the manufacturer and the certification authority according to the division of tasks and principles established in section A of Part 21.

1.18.1.3.1 Obligations of the manufacturer, holder of a type certificate

Article 21 A.3 of Part 21 stipulates that:

- 1) the holder of a type certificate must have a system in place for collecting, examining and analysing the reports and information relative to failures, malfunctions, faults or any other events that has or could have harmful effects relative to maintaining the airworthiness of the product covered by the type certificate.
- 2) the holder of a type certificate must report to EASA all failures, malfunctions, defects or any other occurrences that it is aware of and that has led to or could lead to conditions that might compromise safety (unsafe conditions). These reports must reach EASA within 72 hours following identification of the unsafe condition.

The following definition of "unsafe condition" is proposed in AMC 21 A 3b (b):

(a) An event may occur that would result in fatalities, usually with the loss of the aircraft, or reduce the capability of the aircraft or the ability of the crew to cope with adverse operating conditions to the extent that there would be:

- (i) A large reduction in safety margins or functional capabilities, or*
 - (ii) Physical distress or excessive workload such that the flight crew cannot be relied upon to perform their tasks accurately or completely, or*
 - (iii) Serious or fatal injury to one or more occupants*
- unless it is shown that the probability of such an event is within the limit defined by the applicable airworthiness requirements, or*

(b) There is an unacceptable risk of serious or fatal injury to persons other than occupants, or
(c) Design features intended to minimise the effects of survivable accidents are not performing their intended function.

The document states that certain occurrences of a repetitive nature may be considered to be “unsafe conditions” if they are likely to lead to the consequences described above in certain operational conditions.

Note: Guidance material to 21 A 3b (b) provides a methodology and some examples to determine if an unsafe condition exists.

3) for any deficiency that may reveal a dangerous or catastrophic situation, the manufacturer must look for the cause of the deficiency, report the results of its investigations to EASA and inform it of any action that it undertakes or proposes to undertake to remedy this deficiency.

1.18.1.3.2 Role of EASA.

When EASA considers that an “unsafe condition” has existed or exists and could occur on another aircraft, it can issue an Airworthiness Directive. In this case, the manufacturer must propose corrective action, in accordance with the provisions of paragraph 21A.3B that the Airworthiness directive makes mandatory.

An Airworthiness Directive is a document that imposes actions that must be taken on aircraft of the same type presenting certain common technical characteristics to restore them to an acceptable level of safety. It is drawn up jointly with the manufacturer.

1.18.1.3.3 Arrangements between Airbus and EASA

In September 2003, the responsibilities for continuing airworthiness were transferred from DGAC to EASA.

The regulatory provisions described above are detailed in documents internal to EASA and Airbus.

The procedures that apply to Airbus are described in an internal document covering continuing airworthiness and approved by EASA. This document was the subject of exchanges between DGAC and Airbus in 2002-2003 and was then implemented after the transfer of continuing airworthiness to EASA.

The procedures that apply to EASA are described in an internal document called “Continuing airworthiness of Type Design Procedure”, referenced C.P006-01.

1.18.1.3.4 Working methods

1.18.1.3.4.1 Initial processing of events

Airbus receives from airline operators the events that have occurred in service. An initial sort is performed to determine whether these events effectively correspond to the criteria for notification by operators to manufacturers, as laid down in the EASA AMC 20-8 document. These criteria are adapted to the Airbus fleet and validated by EASA.

Events relating to airworthiness, called “occurrences”, are notified to the manufacturer’s continuing airworthiness unit.

1.18.1.3.4.2 Analysis of occurrences

These occurrences are then analysed in detail each week by a panel of Airbus specialists.

One of the tasks of this review consists of undertaking, for each occurrence, a preliminary evaluation of the impact on airworthiness according to the following classification:

- Occurrence with no consequences for airworthiness. These occurrences are closed quickly;
- Occurrence that can lead to an unsafe condition. These occurrences are subject to processing and closure with EASA (see following paragraph);
- The other occurrences are subject to in-depth analysis and must normally be covered by a risk assessment that allows either for the closure of the occurrence or proposes a plan of action for closure within a period of three months.

After each weekly meeting the list of occurrences that can lead to an unsafe condition is sent to EASA. In accordance with the provisions put in place between DGAC (then EASA) and Airbus, Airbus is authorised to close the other occurrences internally after analysis, identification of the problems and implementation of the corrective measures.

These are issued by Airbus to operators in the form of simple information, reminders relative to procedures, operating or technical methods; or actions, modifications or inspections to be carried out.

1.18.1.3.4.3 Processing of occurrences that may lead to an "unsafe condition"

General principle

These occurrences are processed by Airbus and then presented to EASA at the time of ARMs meetings (Airworthiness Review Meeting) or at the time of specific meetings or phone conferences for urgent matters.

If action is required to remedy an "unsafe condition", EASA may at any moment decide to issue an Airworthiness Directive in coordination with the manufacturer.

Initial processing by Airbus

The follow up of each open occurrence is presented by Airbus to EASA. This follow up includes the history of the occurrence, the safety analysis performed, planned corrective actions and the position of Airbus and EASA, in particular in relation the need to issue an Airworthiness Directive. This document is filled in regularly until closure of the occurrence.

Processing at the ARM meeting

Each occurrence is presented during these meetings which bring together the Airbus and EASA specialists in the area of airworthiness and safety.

This meeting allows:

- Airbus to present for each event the conclusions of its analysis and a corrective actions plan;

- ❑ EASA to examine the work presented by Airbus and, if necessary, strengthen the proposed action plan;
- ❑ Airbus and EASA to reach agreement on the conclusions, the level of impact with respect to airworthiness and the corrective action plan to be implemented.

Where applicable, EASA may decide to issue an Airworthiness Directive.

Note: Certain occurrences are presented to the ARM meeting that are not classified as likely to lead to “unsafe conditions” but for which, due to their recurrent or specific nature, it is decided to put special monitoring in place.

1.18.1.4 Oversight of Airbus, the manufacturer, by EASA

EASA organises the oversight of Airbus’ design agreement in such a way as to cover all of its areas of activity over a three-year cycle. Before the accident, the last audit relating to occurrences had been carried out in November 2007. EASA concluded that the overall organisation was satisfactory.

1.18.1.5 Specific case of inconsistent indicated airspeeds

Cases of inconsistent indicated airspeed, characterised by a sudden reduction in airspeed values, were classified as major by Airbus in its safety analysis, which came from in-service experience. This classification is based on the principle of the existence of a training programme in the planned procedure for flight crew.

Between 1999 and 2001, prompted by several events reported on all types of Airbus aeroplanes and by simulator tests conducted by the CEV (national flight test centre) on behalf of the DGAC, the latter asked Airbus to make several changes leading to:

- ❑ The modification of the existing procedure (creation of memory items);
- ❑ The issuing of airworthiness directives on the inclusion of the unreliable speed indication procedure in the flight manual;
- ❑ The replacement of some Pitot probes originally installed on the Airbus with more recent probes that meet the strengthened specifications developed by Airbus from 1995 (see paragraph 1.18.1.7).

Instruction in the procedure is now also included in the training programme delivered by Airbus. In October 2001, in view of the various changes made, this period of continuing airworthiness was temporarily considered as closed by the DGAC and Airbus.

In September 2003, the EASA officially commenced its duties as the authority responsibility for continuing airworthiness. Since the DGAC was initially the only organisation to have the necessary resources, some of its personnel continued to carry out this role until November 2005 under the responsibility of EASA. When the dossiers for the A330 programme were formally transferred from the DGAC to the EASA in November 2005, the EASA was informed of a case of inconsistent indicated speed in cruise that occurred in 2003, which the DGAC was in the process of analysing.

Between February 2005 and March 2009, Airbus was informed by 10 operators of A330 and A340 aircraft of 16 incidents that had occurred in cruise, and that could be attributed, based on the data available, to a possible obstruction of at least two Pitot probes by water or ice. Nine of them occurred in 2008 and three at the start

of 2009. The manufacturer associated all these incidents with the failure condition manifested by a sudden reduction in several indicated speeds. Airbus's analysis of each of these incidents, based on the data available, revealed that the stall warning triggered briefly on one or more occasions during six of these incidents.

Note: The maximum angle of attack recorded during these six incidents was 4.5 degrees, which validated the activation of the stall warning. In three of these incidents, Airbus's analysis linked the activation of the stall warning with a crew input on the flight controls.

The conclusion reached by Airbus for each of these 16 analysed incidents was that the systems had operated in accordance with their design. On this basis, the manufacturer maintained the classification of the failure condition as major. It confirmed the interim classification attributed during the initial evaluation of each incident. This classification does not require the manufacturer to notify the authority, as described in the approved procedure.

After the transfer of the dossiers in November 2005, EASA was not made aware of any other cases until 17 September 2008 for long-range aeroplanes (A330 and A340), at which date the DGAC forwarded to EASA a letter from the Director of the Air Caraïbes airline concerning two events where there was loss of speed indications on two of the airline's A330s. The letter, in particular, said that he had taken the decision to replace the C16195AA Pitot probes with the C16195BA standard on the entire A330 fleet in accordance with SB A330-34-3206, and asked DGAC for its position regarding this type of incident.

DGAC forwarded this letter to EASA on 17 September 2008 asking it whether it was planning on making Service Bulletin SB A330-34-3206 mandatory by issuing an Airworthiness Directive.

On 16 October 2008, EASA asked Airbus to give a review of the situation concerning this problem at the ARM meeting to be held on 10 and 11 December 2008.

EASA answered by letter dated 18 November 2008 that an assessment of the risk associated with the speed inconsistency problems was currently being examined with Airbus and that it would inform DGAC of its conclusions.

At the time of the December 2008 ARM meeting, the "Pitot icing" theme was on the agenda. Airbus presented 17 cases of temporary Pitot blocking that had occurred on the long-range fleet between 2003 and 2008, including 9 in 2008 without being able to explain this sudden increase.

At this meeting, Airbus indicated that recent events had not provided any new information and that the fleet's airworthiness was not affected. The manufacturer maintained its position and proposed that EASA keep a status recommended for the SB A330-34-3206 (Rev. n°01). This SB no longer mentioned the improvement provided by the C16195BA probes in icing conditions. It was decided to review the situation again at the next ARM meeting.

The situation was reviewed again at the ARM meeting held on 11 and 12 March 2009. No new cases of fluctuation or loss of speed were reported. As a follow up action EASA asked Airbus to make an annual review of problems of this type in order to monitor the evolution of the frequency of occurrence. The Service Bulletin SB A330-34-3206 (Rev. n°01) was maintained as a recommendation.

On 30 March 2009, EASA wrote to DGAC saying that a detailed review of the events for which icing of the Pitot probes was suspected had been carried out with Airbus, and according to this analysis:

- ❑ The events reported in 2008 did not modify EASA's position and these events' classification remained "major";
- ❑ The increase in the number of these events recorded in 2008 could not be explained at that stage and Airbus had been asked to draw up an annual report to determine a trend;
- ❑ In this letter EASA concluded that at this stage the situation did not mean that a change of Pitot probes on the A 330/340 fleet had to be made mandatory.

1.18.1.6 Pitot probe certification process

1.18.1.6.1 General

Based on these regulatory requirements and on its design objectives, the aircraft manufacturer draws up equipment technical specifications for the equipment manufacturers for each piece of aircraft equipment. For the Pitot probes, these specifications include the physical (shape, weight, resistance to shocks, etc.) and electrical characteristics, the degree of reliability sought along with the environmental conditions (behaviour in icing atmospheres, for example). The development of the probe by the equipment manufacturer consists of several phases:

- ❑ Definition/design of the equipment;
- ❑ Development of a prototype;
- ❑ Tests in the laboratory and tests intended to qualify the product with respect to the required specifications;
- ❑ Failure Modes, Effects and Criticality Analysis (FMECA).

FMECA is an inductive approach – as exhaustive as possible – that consists of identifying the potential failure modes, their causes, effects and probability at the level of a system or of one of its subassemblies.

The manufacturer systematically performs tests in the laboratory and in flight to verify that the Pitot probe behaves correctly in as real as possible an environment. The purpose of these tests is specifically to check the interfaces (electrical, mechanical, aerodynamic) between the Pitot probe and the other aircraft systems.

The certification authority can also, at its request, be associated with some of this work.

All these operations and the documents drawn up at the time of each development phase make up the certification dossier which is sent to the certification authority.

Note: The privileges associated to the manufacturer's design agreement allow the authority to rely on the manufacturer's internal processes for checking the justifications produced and thus not receive and examine the whole of the certification dossier.

One of the elements making up this certification dossier is a summary document: Declaration of Design and Performance (or DDP).

This document certifies that the equipment meets the requirements of the certification regulations as well as of the specifications requested by the manufacturer and identifies the main substantiating documents.

When they have been manufactured, and before being put on the market, each probe produced is submitted to an in-depth quality inspection (physical appearance, inspection of the finish, resistance and performance tests, etc).

1.18.1.6.2 Anti-icing certification of the probes

In order to cover all the super-cooled water icing conditions specified in appendix C of JAR 25, Airbus has developed a ten-point test table with different static air temperatures (SAT), speeds, total air temperatures (TAT), water concentrations per cubic metre of air, mean diameters of the water droplets, exposure time, Pitot heating electrical power supply and the probe's local angles of attack in order to cover the aircraft's flight envelope under the following conditions:

- ❑ All the tests are performed with reduced de-icing power (106 VAC instead of 115 VAC);
- ❑ The water concentration values are multiplied by an installation factor (1.5 or 1.7 or 2 according to the speed chosen for the test) with respect to the values in appendix C of JAR 25 in order to take into account the effect of the probe's installation on the aircraft (boundary layer effect). Airbus then applies an additional factor of 2 (design margin coefficient).

In addition to these points, whose aim is to meet the minimum regulatory requirements, Airbus specifies test points aiming to cover additional criteria defined by:

- ❑ STPA specifications CIN3 n°42067 developed by Direction Générale de l'Armement (DGA);
- ❑ A set of specifications developed by Airbus from 1995 onwards and designed to improve the behaviour of the Pitot probes in icing conditions including, in particular, ice crystals, mixed conditions (ice crystals plus super-cooled water) and rain conditions. The diameter of the ice crystals is set at hypothetical 1mm. These specifications include 10 tests in which the static air temperature (SAT), speed, water or ice crystal concentration per cubic metre of water, mean diameter of the water droplets, exposure time, the probe's local angle of attack are varied.

The set of icing tests to be performed to meet the Airbus specification includes 26 test points in all (10 for covering appendix C and 16 additional tests), thus covering a wider envelope than that defined by the JAR25 regulations.

The Airbus specifications used for the certification of the probes are therefore stricter than those of JAR 25 (see appendix 9).

1.18.1.6.3 Pitot probe compliance

Wind tunnel tests are performed by the equipment manufacturers (in this case Thales and Goodrich) to demonstrate the compliance of the probes with the specifications developed by Airbus.

There are many wind tunnels around the world in which this type of test can be performed. Each wind tunnel nevertheless has its limits and its own utilisation envelope in terms of speed, minimum temperature possible and water or ice crystal concentration. It may therefore not always be possible to perform some of the requested tests. Equivalence laws are then used to define similar conditions by varying the parameters in such a way that the amount of water or of ice crystals received by the probe is identical to what is stipulated for the test.

For example: a test must be performed at the speed of 190m/s with a water concentration of 6.3 g/m³. The wind tunnel is limited to a speed of 161 m/s. In this case the water concentration will be increased to 7.55g/m³ ($190/161 \times 6.3 = 7.55$ g/m³) and the temperature of the test will be increased in order to maintain a total temperature identical to the level of the probe.

This similarity method is used internationally and is accepted by the certification authorities.

Note: It is important to note that there are no wind tunnels capable of reproducing all the conditions that the crew may be confronted with in reality.

Furthermore, some scientific studies are under way to characterise the exact composition of the cloud masses above 30,000 ft. They show in particular that not all the phenomena are known with sufficient precision. This is particularly true concerning the nature of ice crystals (size and density) as well as the dividing level of super-cooled water and ice crystals.

The Goodrich 0851HL, Thales C16195AA and Thales C16195BA probes were certified on Airbus A330 respectively in November 1996, April 1998 and April 2007 and meet all the requirements listed in § 1.18.6.2.2.

1.18.1.7 History of the Pitot probes on Airbus A330

The Airbus A330s were initially equipped with Goodrich 0851GR probes.

In August 2001, following fluctuations and/or losses of speed indication on A330 reported by certain airlines, the French DGAC published Airworthiness Directive 2001-354 (B) which made mandatory the replacement on A330 of the Goodrich 0851GR probes either with Goodrich type 0851HL or by Thales type C16195AA probes before 31 December 2003. According to the analysis carried out at the time, the most likely cause of the problem was the presence of ice crystals and/or water in the Goodrich 0851GR type Pitot probes within the upper limits of the original specifications, which did not include the additional specifications defined by Airbus from 1995.

In September 2007, following measured speed inconsistencies observed at the time of heavy precipitations or icing conditions on A320 and some cases on A330/340, Airbus published Service Bulletin SB A330-34-3206 (Rev. n°00) which recommended the replacement of C16195AA Pitot probes with the C16195BA standard. The Service Bulletin indicated that this model performed better in the case of water ingestion and of icing in severe conditions.

Note: The C16195BA probe was initially developed in 2005 to answer problems relating to water ingestion observed on the A320 family during strong precipitation at low altitude.

On 12 November 2008, SB A330-34-3206 was revised by Airbus (Rev.n°01). This Bulletin mentions the improvement that can be provided by the Thales C16195BA probe in relation to water ingestion and no longer mentions the improvement that the Thales C16195BA probe can provide in icing conditions.

In February 2009, Thales carried out a comparative study of the behaviour of the two C16195AA and C16195BA standards in icing conditions that were more extreme than required by the specifications.

This study concluded that, in the icing conditions tested, the C16195BA standard performed better while saying, nevertheless, that for technical reasons it was not possible to reproduce in the wind tunnel all the conditions that may be encountered in reality.

1.18.1.8 Crew training associated with a type certificate

Current process

Section 3.3.6 of ACJ 25.1309 details how the crew's action should be considered when evaluating the consequences of a failure condition. It states that training requirements must be specified in certain cases.

There are no approved materials or devices dedicated to crew training and exercises that are specific to a type certificate and that integrate the characteristics identified during certification or during continuing airworthiness.

The exercises performed for the purposes of type rating may be evaluated at the request of the manufacturer by the EASA via the OEB (Operations Evaluation Board). The evaluation may identify specific subjects that the exercises should address more thoroughly. The OEB's recommendations may be used by the authorities responsible for approving training organisations as the basis for their approval decisions. The latest evaluation regarding the Airbus A330 was performed in 2004 by the JOEB (Joint Operations Evaluation Board, established by the JAA). This evaluation found that there was no requirement for specific training associated with the failure conditions.

The assumption made by the EASA with regards to the classification of the failure conditions is that the crew has the basic aircraft handling skills and has received, for the type of aircraft in question, the training necessary to apply the check-lists and the procedures described in the flight manual. The exercises likely to be conducted by an operator are not considered during the certification, even though they contribute towards improving the level of safety.

Note: during the evaluation of a procedure associated with a failure condition, EASA checks on the simulator, in a scenario defined by the manufacturer, if it is appropriate. Pilots introduce imprecision into the performance of the procedure in order to evaluate its robustness.

Operational Suitability Data (OSD)

Since 2006, EASA has been working on developing a regulatory reference system implementing the OSD concept with the objective of associating it with the type certification of new aircraft. The main aim is to supply data to operators to define and improve the training of pilots, cabin crew, and maintenance personnel. It can also include specific conditions and/or limitations adapted to various types of operations.

The data itself will be compiled by the manufacturer and approved by the EASA for use in type certification. It is planned that operators and training organisations will apply the minimum mandatory provisions.

1.18.2 Information supplied to flight crews on the unreliable IAS situation

Information supplied by Airbus

The “unreliable speed indication” procedure (appendix 6) for the Airbus A330 appears in the FCOM and in the QRH supplied to operators.

In addition, the phenomenon is described in several documents that the manufacturer sends directly to the client airline’s air operations entity, or makes available to them via various media:

- ❑ The Flight Crew Training Manual (FCTM) is presented as a supplement to the FCOM and provides crews with practical information about the operation of Airbus aircraft. The causes of inconsistent indicated speeds and their consequences on system operation are presented in the section of the FCTM entitled “Abnormal operations – navigation”. This section particularly describes the various failure modes as a function of the number of defective sources, or as a function of the degree of similarity between the various incorrect indications. The section below is dedicated to the ADR CHECK PROC / UNRELIABLE SPEED INDICATION procedure. It describes, in overall terms, how this procedure should be applied from the identification of the anomaly as a starting point up to the use of the reference attitude/thrust data.
- ❑ FCOM Bulletin No. 810/1 of June 2004 describes the operation of Pitot-static systems, the various causes and consequences of unreliable indicated airspeeds, and the key elements of the operational procedures recommended by Airbus.
- ❑ The training materials associated with the Maintenance Flight Training Device (MFTD) includes⁽¹⁶⁾ a presentation of the inconsistent indicated speeds resulting from the obstruction of the Pitot probes. The document presents six criteria for detecting the phenomenon, then describes how the procedure should be implemented, from the memory items through to the use of the reference attitude/thrust data provided in the QRH.
- ❑ The Flight Crew Training Program (FCTP) is a document intended exclusively for instructors. It presents the training programme delivered by Airbus’s TRTO and includes details of the type rating and CCQ programmes, in addition to the recurrent training. In the FCTP, an unreliable indicated speed exercise in a flight simulator is scheduled for the 21st day of the type rating course. The scenario for this exercise features the simultaneous insertion, at take-off at 900 feet QNH, of a “Pitot obstruction” on the co-pilot’s side and an “ADR 3 FAULT” then, at 1,800 feet QNH, an “AIRSPEED CHANNEL ADR 1 FAULT”. The main stated objective is to familiarise crew with the procedure, starting with the memory items necessary to stabilise the flight path.
- ❑ The materials used during the briefing prior to the exercise in a flight simulator, is common to all Airbus fly-by-wire aircraft. Based on the unreliable airspeed procedure, the presentation describes the actions that should be taken at the various phases of an approach to landing: when the failure occurs (notably the

⁽¹⁶⁾Session scheduled for the 14th day of the standard type rating course.

execution of the memory items, adapted to the situation based on the MSA or the circling altitude); when the flight path has stabilised; when the MSA or the circling altitude has been reached and during the approach.

In addition, Airbus regularly invites all its operators to participate in conferences, during which various safety themes are discussed. Between 1998 and 2008, during these events, about ten presentations addressed the issue of unreliable indicated speed. These presentations covered:

- The various possible causes of unreliable indicated speed, such as Pitot icing, water ingestion, the disconnection of an ADR;
- A description of the anemometric system, the link with the various flight systems that might be affected and the various forms that the unreliable indicated airspeeds might take;
- How to detect unreliable indicated airspeeds and the pitfalls associated with each failure mode;
- The content and logic of the associated procedures;
- The technical and operational changes made or being made;
- The analysis by Airbus of several incidents that have occurred in operation, primarily during the transition phases (take-off, climb, descent, landing).

Several presentations that were made emphasised that the provision of information to crews and training were presented as indispensable means of prevention alongside the changes made to the systems or to the procedures.

The presentation in 2008 focused on:

- "Startle" effects associated with these events;
- Stall risks associated with flying at high altitude;
- Possible confusion between buffeting at high and low speeds.

Changes in procedures relating to inconsistent airspeed indications

	FCOM / TU	QRH
November 1997	Airbus A320 FCOM Rev 24	Airbus A320 FCOM Rev 24
April 1998	Air France (03.02.34.89) ATA 34 Navigation	Air France: no procedure in the QRH
July 1998	Airbus A320 Rev 26	Airbus A320 Rev 26
November 1998	A320 type rating co-pilot in left seat	
December 99	Air France: ATA 34 Navigation Appearance of immediate actions Distinction between immediate actions and actions when flight has stabilised	
May 2001	A320 type rating Captain	
October 2001	Airbus: Self-learning module including PowerPoint briefing of erroneous speeds (standard type rating)	
June 2002	Airbus A320 Rev 35 Procedure moved from Miscellaneous (03.02.80) to Navigation (03.02.34) Additional memo on conditions of application of <i>Unreliable Speed Indication</i> vs. <i>ADR Check</i> . Description of symptoms and consequences of the <i>Unreliable Speed Indication</i> . Description of conditions of application according to their impact (or absence of impact) on the flight controls.	Airbus A320 Rev 35
31 October 2002	Air France: 3.02.34.85 Explanatory note on the context of use of the <i>ADR Check</i> and unreliable IAS procedures. Application rule for unreliable IAS vs. <i>ADR Check</i> procedures	
June 2004	Airbus: FCOM Vol 3. inclusion of the bulletin 810/1: notes and details on systems and Unreliable Speed procedures (including a list of possible symptoms linked to erroneous speed or altitude information, including the possible existence of the " <i>undue stall warning</i> ")	

1.18.3 Information on the Stall

1.18.3.1 Background Information on stalls

The lift of an airfoil depends on its aerodynamic coefficient (C_l) and the square of the speed of the airflow. The aerodynamic coefficient increases with the angle of attack (noted as α) up to a maximum value, after which it decreases when the angle of attack continues to increase. This tipping point, where the aerodynamic coefficient is at maximum is the marker, from an aerodynamic point of view, for the stall. The angle of attack at which the C_z is at a maximum is thus the stall angle of attack (α_{max}).

The aerodynamic characteristics of an airfoil, thus the evolution of the $C_l = f(\alpha)$ curve, are different between the lower layers (low Mach, subsonic airflow, incompressible air) and the high altitudes (higher Mach, airflow close to trans-sonic, influence of the compressibility of the air).

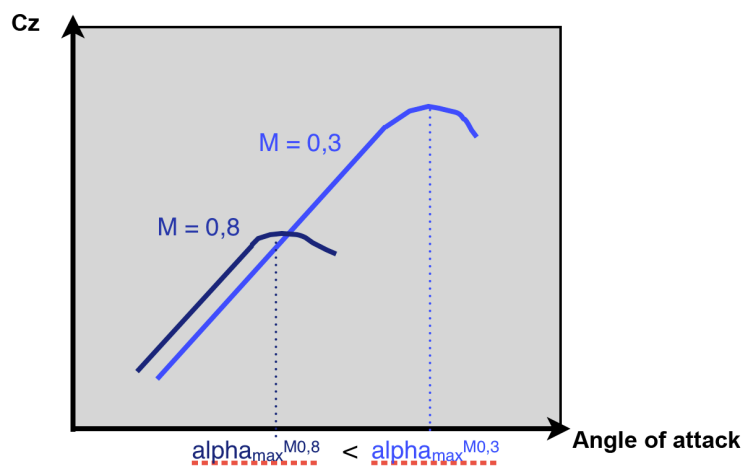

Figure 88: Lift graph with high and low Mach

In a more significant manner at a high Mach, the compressibility of the air is notably manifested by the appearance of buffet at a high angle of attack, whose amplitude can then increase until it becomes dissuasive (deterrent buffet). Test flights are then stopped before reaching C_{lmax} . It is then considered that the C_{lmax} is the maximum C_l reached during the manoeuvre.

Note: The appearance of buffet (buffet onset) is defined by an oscillatory vertical acceleration whose amplitude reaches 0.2 g from peak to peak at the pilot's seat. The notion of deterrent buffet is subjective. It is neither known or shared by the airline pilot community.

Note: This type of test flight is always undertaken during the day, in VMC conditions and in a calm atmosphere.

Airbus indicated that apart from the appearance of the aural stall warning, a stall generally manifests itself through the following phenomena:

- Buffet, sometimes pronounced;
- Lack of pitch authority;
- Difficulty in controlling roll;
- Impossibility of reducing the rate of descent.

1.18.3.2 Flight envelope and margin for manoeuvre at high altitude

The lift equation in straight, level flight at a given flight level can be noted as:

$$m.g = K.P_s.C_l.M^2$$

where P_s is the static pressure, M is the Mach number, K is an aeroplane-dependant constant

At the aerodynamic ceiling, C_l is equal to C_{lmax} , so that $m.g = K.P_s.C_{lmax}.M^2$. There is therefore a direct relation between $C_{lmax}.M^2$ and the flight level. The flight envelope can then be represented by tracking $C_{lmax}.M^2$ as a function of M :

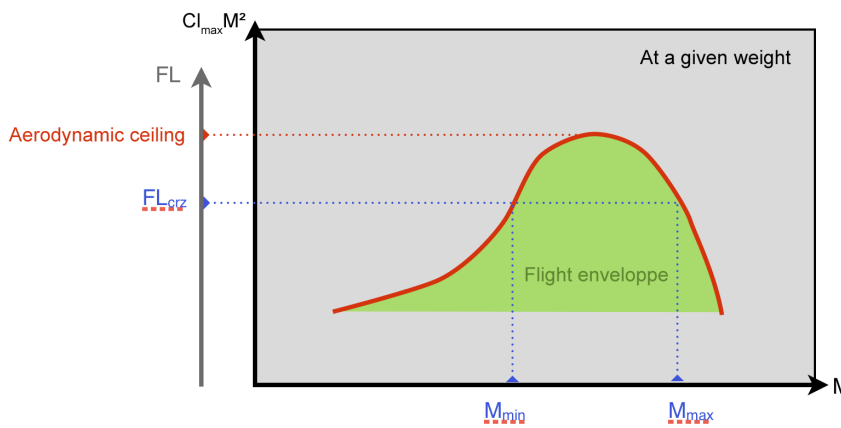

Figure 89: Flight envelope at high altitude

Thus, at a fixed mass and flight level FL_{crz} , the flight envelope is framed by two Mach values:

- ❑ The lower limit M_{min} marks the stall, associated with the appearance of the first of the following phenomena:
 - A loss of lift and the impossibility of maintaining level flight,
 - The presence of deterrent buffet;
- ❑ The upper limit M_{max} , on the other hand, is linked to the effects of the compressibility of the air. It is also defined by the presence of buffet.

Note: This upper limit M_{max} was never encountered on the A330, even during test flights. The upper limit on this aeroplane is MMO which does not depend on altitude and includes structural and aero-elastic limitations (the tests are continued up to MD , thus $MMO+0.07$).

The higher the cruise level, the more the available Mach range is reduced. In an extreme case, the maximum altitude at which the aeroplane can fly (aerodynamic ceiling) can only be reached and maintained at a very special Mach. This maximum altitude can in addition be limited by the propulsive capacities of the aeroplane: this is known as the propulsion ceiling. This is the case for the Airbus A330.

Note: The aerodynamic ceiling is a theoretical notion. Operationally, the mark range available at a given level is generally between VLS and MMO .

1.18.3.3 Basic training

Both theoretical and practical knowledge of stall phenomena, as well as the associated recovery manoeuvres is taught to pilots on light aircraft.

The test allows in particular for the examiner to check the student's ability to recover a stall in various configurations.

1.18.3.4 Theoretical training during ATPL certificate

The ATPL certificate theory explains the phenomena of wing stall and the corrective manoeuvres to perform (reducing angle of attack and appropriate use of thrust).

Note: Its introduction indicated that "a stall is a dangerous phenomenon which is expressed mainly by loss of altitude".

1.18.3.5 Airline training

1.18.3.5.1 Crew training

Stall phenomena are covered during the initial A320 type rating, according to the same philosophy of the manufacturer and the operator. They are not reviewed during the long haul passage, in CCQ 330, or during recurrent training.

At the time of the accident, the immediate actions were: simultaneously reducing angle of attack and applying TOGA thrust from the first signs of the stall (Stall warning / buffet onset). A minimal loss of altitude was expected.

The procedure for reacting to the stall warning at the time of the accident was in the "additional abnormal procedures" or in the "supplementary techniques" section of the Airbus FCOM. As a result of this classification, the procedure was not reviewed during the ECPs.

Note: The "additional abnormal procedures" section was not repeated in the QRH.

Type rating training is carried out in an analytic way (demonstration) and at low altitude.

The aim is to demonstrate:

- The operation of protections in normal law (high angle of attack protection / Alpha-floor);
- The operation in the event of control law deterioration (alternate law);
- The first signs of a stall (STALL warning, buffet onset, see also paragraph 1.18.4.3).

1.18.3.5.2 Manufacturer's information to operators

In its 9th training symposium held in Paris in December 2008, the manufacturer discussed the theme of "aeroplane upset recovery". This symposium aimed to stress the main principles of the revision of the "Aeroplane upset recovery training aid" document.

It developed the following points:

- Principles and techniques of flight at high altitude;
- Stalls;
- Problems that could lead to a stall on Airbus (misuse of automated systems/Pitot probe freezing);
- Recovery techniques.

In the symposium, Airbus indicated:

- The need for crew to contain the “startle factor”, and to make measured inputs on the controls;
- That a low speed stall could be confused with high speed buffet.

Note: It was not indicated that high speed buffeting was a phenomenon that does not occur on fly-by-wire Airbus.

Note: In addition, it is mentioned in the FCTM that the existence of protections makes training in unusual attitude recovery training superfluous.

1.18.3.6 Changes in the “STALL” procedure

The first member of the crew to obtain A320 type rating within Air France, in November 1988, was the co-pilot in the left seat.

At that time, there was no STALL procedure in Air France’s operating manual. The Airbus procedure, in effect since November 1997, is included in appendix 11.

The table below summarises changes to this procedure:

	FCOM	QRH
November 1998	A320 type rating CO-PILOT in left seat	
December 1999	Air France: Additional Abnormal Procedure TU 03.03.27.01	
May 2001	A320 type rating Captain	
September 2004	A320 type rating CO-PILOT in right seat	
July 2006	Airbus: Addition of note on possibility of STALL warning at take-off if AOA sensor is damaged. Introduction of distinction between take-off and other flight phases	
September 2006		Air France: Procedure in the PAC list (04.30.01)
February 2007 (330/340) October 2007 (320)	Air France Addition of note on possibility of STALL warning at take-off if the AOA sensor is damaged, leading to the appearance of the distinction between take-off and the other flight phases. Procedure in force at the time of the accident	

Note: Stall and stall recovery exercises are undertaken during initial pilot training (in particular basic training, private pilot, professional pilot, etc.) but not during type rating training.

1.18.4 Simulator fidelity

1.18.4.1 Purpose of simulator training

Flight simulators are used to train pilots to apply normal, abnormal and emergency procedures. The exercises may be characterised by an analytical approach (descriptive exercises, option to interrupt or pause the exercise) or a real-life approach (realistic scenario, conditions similar to those in flight, no intervention from the instructor).

Depending on the stage in the training and on the associated educational objective, this training may be carried out using different types of simulator: MFTD, FNPT, FBS or FFS which offer different levels of realism (e.g. fixed or motion platforms, systems identical to those on the aircraft or generic).

1.18.4.2 Qualification process for a Full Flight Simulator (FFS)

Flight training tools, a category that includes Full Flight Simulators (FFS), are not certified in the way that aircraft are; instead they must be qualified by the national civil aviation authorities of the country in which the simulator is operated.

The regulatory criteria applicable to this qualification are defined in Europe by the two documents: JAR-FSTD A of 1 May 2008 and ICAO document 9625.

A simulator represents a reference aircraft selected by the operator, whose descriptive standard is documented. The qualification of a simulator is a two-step process:

- ❑ Validation (proof-of-match) tests compare the behaviour of the simulator with that of the aircraft. A set of technical data (the data package) compiled during flight tests and aircraft certification serve as reference data for this objective comparison. The data only covers the aircraft's known flight envelope;
- ❑ Functional tests are conducted by an expert pilot appointed by the competent authority responsible for simulator qualification. These tests are based on a standard flight profile lasting 2 to 3 hours, during which the expert pilot evaluates subjectively the degree of realism provided by the simulator. This evaluation covers the visuals, system operation, the ergonomics of the controls and more generally the flying sensations (vibrations, noise) which must be identical to those experienced in the aircraft.

These tests are described in a Qualification Test Guide (QTG) that is accepted by the authority.

Every flight simulator requires its own qualification. It is valid for one year (unless otherwise indicated by the authority) and for a given simulator standard. Any change therefore requires a new qualification. Similarly, if there are differences with the operator's other aircraft, they must be covered by a briefing note.

1.18.4.3 Fidelity of the simulator's recreation of the approach to stall and developed stall phenomena

The data package used to qualify the simulator includes a set of values that define the onset of buffet, such as amplitude and frequency. These values let the simulator reproduce the onset of buffet as the aircraft approaches stall.

In a developed stall situation the aircraft has left its known flight envelope. The data package does not contain any data relevant to this situation. The simulator is not representative of the aircraft in a developed stall situation; it does not reproduce the deterrent buffet effect.

During initial type rating training, the exercises are designed to teach pilots how to avoid, recognise and escape from an "approach to stall" type situation. This approach trains the pilots to recognise the signs of an approach to stall (warning, stickshaker, according to the type of aeroplane) so that they can take corrective action. These exercises provide no guidance in how to recover from a developed stall situation.

1.18.4.4 Fidelity of the recreation of loss of indicated speed situations

At Air France, one of the features of the exercise scenario for the loss of speed indication was that the deviation in the three ADR's was similar, such that no ECAM alarm was generated. The crew had to recognise an inconsistency between the speed and the attitude and thrust parameters. To address this inconsistency the crew were required to apply the "IAS douteuse" emergency manoeuvre, and then the QRH procedure. The crew had to determine and input the pitch attitude and thrust values applicable to climb, level flight, descent and approach, thus covering all the flight phases at low altitude (lower than FL100).

Air France pilots indicated that during this exercise there was no or little surprise or startle effect, and that the decision to apply the emergency manoeuvre was expected.

1.18.4.5 Information reported by the manufacturer and the operator

The information provided by Airbus and Air France managers highlighted the following:

- The data currently available in the data packages prevents the simulator's flight envelope from being extended, since the data in this package is limited to the aircraft's known flight envelope;
- Simulators do not indicate to the pilots and instructors that the simulator has been taken outside the envelope validated by the data packages. Improvements to this situation would appear, however, to be possible;
- The startle effect is difficult to create and/or maintain. The scenarios soon become known to the trainees, giving them the opportunity to prepare for the failures in advance. In this context, the instructors have an important role to play;
- The exercises conducted by the French air force when they train pilots to work under stress currently appear to set the standard in this field.

1.18.4.6 Work currently underway on simulator fidelity and training

Following the accident to the DHC-8-400 operated by Colgan Air⁽¹⁷⁾ on 12 February 2009, one of the NTSB's recommendations (A-10-24) was that operators (notably of public transport aircraft) should define and codify minimum simulator model fidelity requirements to support the training of pilots in how to recover from stalls, including stalls that are fully developed. These simulator fidelity requirements should address areas such as angle of attack and sideslip, motion cueing, proof-of-match with post-stall flight test data, and warnings to indicate when the simulator flight envelope has been exceeded.

Moreover, questions relating to simulator fidelity are often considered in the context of changes to the training of pilots in recovering from unusual attitudes (upset recovery) and loss-of-control, with stall being one example.

In this context, the ICATEE (International Committee for Aviation Training in Extended Envelopes) working group studied ways of improving training in these situations. This working group, led by the Royal Aeronautical Society, is made up of representatives from manufacturers (e.g. Airbus, Boeing, CAE), authorities (FAA, CAA UK), operators (e.g. Alaska Airlines, Fedex) and the scientific community (universities, researchers). It issues technical and regulatory proposals, notably for the attention of the ICAO.

⁽¹⁷⁾<http://www.nts.gov/doclib/reports/2010/AAR1001.pdf>

One section of this group works on technical issues regarding simulator fidelity in terms of their visuals and motion. The other sub-group studies desirable changes in terms of training scenarios and regulation

The working group's conclusions have not yet been formally stated, but emphasise the following:

- ❑ Pilots must learn to avoid the situations that lead to losing control, and know how to recognise and escape from them if they do occur;
- ❑ This learning must be reiterated over the entire duration of pilot training, from initial training (PPL) to recurrent line training;
- ❑ The instruction must be based on a range of educational aids: theoretical study, demonstration in video form, and practice in a simulator and in flight (in acrobatics-enabled aircraft);
- ❑ Simulator fidelity must be improved to avoid the risks of negative training;
- ❑ A simulator capable of recreating unusual attitudes could be developed that is generic, and unrelated to one particular aircraft type;
- ❑ The design of the training must be such that it generates surprise and startle effect to teach the pilots how to react to these phenomena and how to work in stressful situations, in order to prepare the trainees for the actual operating environment.

Current discussions coordinated by the EASA and the ANAE⁽¹⁸⁾ also emphasise the need to train pilots to deal with the effects of surprise and stress to ensure that the training faithfully recreates real-life situations.

1.18.5 Testimony

1.18.5.1 Crews in flight in the vicinity of the accident zone

In order to more closely determine the environment of flight AF 447, the BEA made a list of flights close to airway UN 873 during the night of 31 May to 1st June 2009 and asked crews for testimony.

➤ FLIGHT IB6024

Flight IB6024 (Airbus A340) passed at the level of the ORARO waypoint at FL370 approximately twelve minutes after AF 447.

The crew saw AF 447 take off while taxiing at Rio de Janeiro. When passing the INTOL waypoint, they encountered conditions typical of the ITCZ. These conditions were particularly severe 70 NM to 30 NM before the TASIL waypoint. They moved away from the route by about 30 NM to the east to avoid cumulonimbus formations with a significant vertical development, and then returned to the airway in clear skies close to the TASIL waypoint. The crew reported they had difficulties communicating with DAKAR ATC.

➤ FLIGHT AF459

Flight AF459 (Airbus A330-203) passed at the level of the ORARO waypoint approximately 37 minutes after AF 447. The sky was clear but the half-moon, visible to the aft left of the aircraft, did not make it possible to see the contour of the cloud mass distinctly. After flying through a turbulent zone in the head of a cumulus congestus formation at the level of NATAL, without having detected this zone on

⁽¹⁸⁾EASA conference "Staying in Control – Loss of Control" 4 and 5 October 2011 ANEA (French national air and space academy) conference "Air transport pilots facing the unexpected" 29 and 30 November 2011.

the radar, the Captain selected gain in MAX mode. At about 2 h 00, he observed a first return that differed significantly depending on whether the radar's gain was in CAL or MAX mode. The TILT was set between -1° and 1.5° . He decided to take evasive action to the west, which resulted in a deviation of 20 NM to the left of the route. During this evasive action, a vast squall line with an estimated length of 150 NM appeared on the screen, which was set to a scale of 160 NM. The returns were yellow and red when the radar was set with gain on the MAX position and green and yellow when the gain was on the CAL position. No lightning was observed.

ATLANTICO control, informed by the crew of their decision to avoid this squall line by taking evasive action to the east, asked them to return to the airway as soon as they could. This evasive action meant the aircraft flew between 70 and 80 NM to the right of the planned route. In addition, the crew was authorised to climb from FL350 to FL370.

On leaving the ATLANTICO FIR, through the TASIL waypoint, the crew attempted in vain to contact DAKAR control in HF on the 5565 KHz and 6535 KHz frequencies, and on the other HF frequencies given in the on-board documentation. Likewise, the attempted ADS-C connection was unfruitful.

The crew returned to the airway around the ASEBA waypoint, that is to say more than 28 minutes after the first theoretical contact with DAKAR control. They reported slight turbulence on the edge of the convective zone.

Radio contact was established with DAKAR control at about 3 h 45, close to the SAGMA waypoint. The SELCAL test was performed and the controller asked the crew to try to contact AF 447. Several attempts were made on various HF frequencies, and then on 121.5 MHz and 123.45 MHz, without any success.

➤ **FLIGHT LH507**

Flight LH507 (B747-400) preceded flight AF 447 by about twenty minutes at FL350.

The crew reported that it flew at the upper limit of the cloud layer and then in the clouds in the region of ORARO. In this zone they saw green returns on the radar on their path, which they avoided by changing their route by about ten nautical miles to the west. While flying through this zone, which took about fifteen minutes, they felt moderate turbulence and did not observe any lightning. They lowered their speed to the speed recommended in turbulent zones. They saw bright St Elmo's fire on the windshield on the left-hand side. The crew listened into the 121.5 MHz frequency throughout the flight without hearing any message from AF 447.

1.18.5.2 ATLANTICO controllers

The controller of the ATLANTICO ACC explained that he had asked the crew to give its estimated time of arrival at the TASIL waypoint. He attributed their failure to reply to the fact that the crew had probably lowered the volume of their radio. He expected to receive position reports from the crew as they passed the ORARO and SALPU waypoints. For this reason, he did not attempt to call the crew via the SELCAL.

The controller waited for the position report from the crew at the ORARO and then SALPU waypoints to update the estimated time of arrival at the TASIL waypoint. He did not receive a report from the SALPU waypoint, but observed on his radar screen that the aircraft had flown over this waypoint at 1 h 49 min.

At 2 h 00, the controller was relieved. His successor did not receive a position report from the ORARO waypoint. He then waited for a report of the passing of the TASIL waypoint. The controllers indicated that on that night, the HF communications were very poor.

1.18.5.3 DAKAR controllers

The controllers of the DAKAR Oceanic ACC on duty at the time of the event indicated that, on that night, numerous flight plans were not received. They added that the quality of reception of the HF used deteriorated during their shift. They stated that they had not been concerned about the absence of radio contact with AF 447, since aircraft frequently crossed all or some of the DAKAR Oceanic FIR without making radio contact. They indicated that they had not been informed, when coordinating with the Brazilian controller, of the loss of radio contact between AF 447 and Brazil. In anticipation of a change of shift, the display of the air traffic on the Eurocat screen was updated by “accepting” all the flight plan tracks. The shift changed at 2 h 30.

The controllers on duty for this new shift indicated that they had coordinated with regards to AF 447 with the controller of the SAL ACC, by providing them with the estimated time of entry into the SAL FIR. They specifically clarified that no radio communication had been established with the flight. At 8 h 30 they informed the head of the air traffic office of the absence of contact with AF 447. The latter passed on this information to the DAKAR RCC.

1.18.6 Previous Accidents and Recommendations

Accidents with a relation to airspeed problems

➤ **Accident on 1st December 1974 to the Boeing 727 operated by Northwest Airlines**

The aeroplane was scheduled to undertake flight 6231 between New York JFK, NY (United States) and Buffalo, NY. About 10 minutes after take-off, the crew noticed that the speed and the rate of climb were very high, respectively 405 kt and 6,500 ft/min. A little later the overspeed warning triggered, quickly followed by the stall warning (stickshaker). The crew attributed the stickshaker to the appearance of « Mach buffet » and tried to reduce the indicated speed. The aeroplane levelled off towards 24,800 ft and then stalled. It went into an uncontrolled spiral spin during which the stabilizer separated from the aeroplane. It struck the ground about 1 minute 20 after beginning its descent.

The NTSB report identified the probable cause of the event as being the loss of control of the aeroplane due to the crew not recognising and correcting the aeroplane’s situation : high angle of attack, low speed stall and spiral descent. The report specified that the stall was caused by inappropriate crew reactions to erroneous speed and Mach displays that resulted from blockage of the Pitot probes through atmospheric icing. The report stated that contrary to standard operating procedures, the crew had not switched on the Pitot probe heating.

The NTSB issued three recommendations to the FAA including one to issue a safety information bulletin to inspectors in order to underline the need for pilots to use pitch attitude information when other displays linked to the airspeed measurement systems are unreliable. It stated that the content of this bulletin should be distributed widely to operators so that the latter would include it in their procedures and training programmes.

➤ **Accident on 6 February 1996 to the Boeing 757 operated by Birgenair**

The aeroplane was scheduled to undertake flight 301 from Puerto Plata (Dominican Republic) to Frankfurt. During the takeoff run the Captain noticed that his speed display was not working. The copilot's was working so he decided to continue the takeoff. During climb towards 4,700 ft the Captain's speed display indicated 350 kt, which led the autopilot to increase the pitch attitude and the autothrottle to reduce thrust. The crew received « Mach airspeed » and « rudder ratio » warnings. The different speed displays and the simultaneous triggering of the overspeed and stall warnings (stickshaker) led to confusion in the cockpit. Noticing finally that the aeroplane was losing speed and altitude, the crew disconnected the autopilot and applied maximum thrust. A short time later, a GPWS warning sounded and the aircraft struck the sea a few seconds later.

The commission of inquiry determined the probable cause of the accident was the crew's failure to recognise the activation of the stickshaker as a sign of an imminent stall as well as their failure to apply appropriate procedures to recover control of the aircraft. The report further states that:

- ❑ The erroneous speed displays were caused by a Pitot probe being blocked, probably by local insects, the aeroplane having remained on the ground for maintenance for 20 days before the accident flight;
- ❑ During the climb, the crew never discussed or brought to light the fact that procedures were available to manage a situation with erroneous airspeeds;
- ❑ The pilots never focussed their attention on the greatly increasing pitch attitude, nor on the alternative speed indications presented on other instruments;
- ❑ The obstruction of the Pitot probe was not the probable cause of the accident, although this was a contributing factor;
- ❑ This accident shows that international requirements for the training of flight crews had not been maintained at a level that was consistent with the expansion and modernisation of the aviation transport industry and the development of modern aeroplanes.

Several safety recommendations were issued by the commission of inquiry, in particular on information supplied to pilots to understand such a problem, on adding a specific warning on unreliable airspeeds and on pilot training.

➤ **Accident on 2 October 1996 to Boeing 757 operated by Aeroperu**

The aeroplane was scheduled to undertake flight 603 from Lima (Peru) to Santiago (Chile). Immediately after takeoff the crew noticed that the altitude and speed displays were changing in an abnormal manner. They received a windshear warning, despite very calm weather and declared an emergency with the intention of returning to land at Lima. The aeroplane climbed up to a maximum of 13,000 ft and then began to descend. During the descent, the speed displayed to the Captain was so high that it triggered the overspeed warning even though the stall warning (stickshaker) was also active. The total confusion that ensued in the cockpit led the pilots to depend on the altitude indications given by the controller without realising that it was information supplied by the aeroplane itself in response to a radar signal which was thus false. After about 30 minutes of flight the aeroplane finally struck the sea off the coast of Lima.

The investigation showed that the static pressure sensors had been covered with adhesive tape before a maintenance operation, but that these had not been removed. The report said that this was the cause of the accident, but also that the crew should have taken into account the GPWS warning that sounded just before the collision with the sea and the height values from the radio altimeter. It made several recommendations, specifically on training and recurrent training for pilots and the modification of maintenance practices. It should be noted that many crews, not only with this operator, had not received any of the information that should have been given to them urgently following the accident to the Birgenair Boeing 757 in the Dominican Republic eight months previously.

Accidents related to loss of control of flight path in a stall situation

Other recent accidents were caused by loss of control of the aeroplane flight path in a stall situation. At the authorities' request, the investigation reports led to the creation of various working groups made up of academics, manufacturers, operators and authorities.

In liaison with stall issues, the causes and recommendations reported in these accidents are summarised below.

➤ **Accident on 22 December 1996, DC-8 operated by Airborne Express**

Cause:

- Inappropriate inputs by the PF on the controls and ineffective monitoring by the PNF to identify and recover a stall situation.

Contributing Factor:

- Simulator fidelity in relation to a stall.

Recommendations:

- Improvement of characteristics of flight simulators to represent a stall;
- Development of guides on stall training;
- Practising stall recovery in simulator;
- Presentation to pilots of the angle of attack and training in using this information

➤ **Accident on 14 October 2004, CL-600 operated by Pinnacle Airlines**

Cause:

- Stall following crew inputs

Recommendations:

- Improve training in operations at high altitude;
- Training for stall recovery at high altitude.

➤ **Accident on 16 August 2005, MD-82 operated by West Caribbean Airways**

Cause:

- Failure to take actions to prevent a stall, and defective CRM (lack of effective communication, decision making process, ranking of priorities), enabling neither the prevention nor the identification of a stall situation and as a result making inappropriate inputs.

Recommendations:

- Knowledge of aeroplane performance in terms of altitude limitations;
- Simulator training on identifying a stall at high altitude and on recovery procedure;

- ❑ Training crew at high altitude in variations in angle of attack, speed and their effects on the energy condition of the aeroplane;
- ❑ Implementation of a CRM training programme linked in particular to the execution of memory items. The programme can use the accident scenario to check the development of the situation and the execution of appropriate actions;
- ❑ Reinforcing awareness of the situation and of effective communication during CRM training courses “in order to effect a definitive change in the operational culture of flight crew, enabling them to decide openly and with the required professional maturity”.

➤ **Accident on 27 November 2008, A320 operated by XL Airways Germany**

Cause:

- ❑ Loss of control of the aeroplane by the flight crew following an improvised demonstration of the functioning of the angle of attack protections, when the blocking of the angle of attack sensors made it impossible for these protections to be triggered.

Recommendation:

- ❑ Evolution in training exercises and procedures relating to techniques on approach to stall.

➤ **Accident on 12 February 2009, DHC Q400 operated by Colgan Air**

Causes:

- ❑ Inappropriate inputs by the Captain in response to the activation of the stick shaker, leading to aeroplane stalling;
- ❑ Insufficient monitoring of the speed parameters;
- ❑ Absence of flight management by the Captain.

Recommendation:

- ❑ Training that includes recovery from proven, unexpected stalls that lead to AP disconnection.

1.19 Useful or Effective Investigation Techniques

1.19.1 Resources used for phase 4

Phase 4 proceeded on site from 25 March to 9 April 2011 with the same underwater equipment that had already been used in the previous campaign (phase 3). The resources involved were two REMUS 6000 autonomous underwater vehicles (AUV) belonging to the Waitt foundation and the German oceanographic institute Geomar (Research Center for Marine Geosciences). These vehicles were operated by the Woods Hole Oceanographic Institute (WHOI) from the exploration vessel M/V Alucia.



Figure 90: Alucia

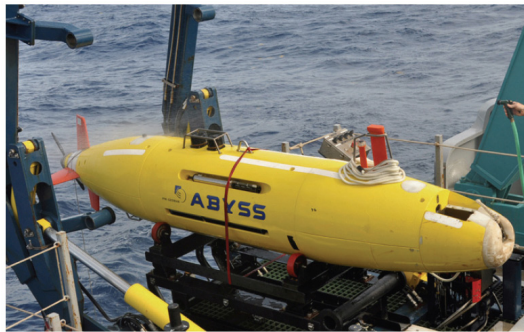

Figure 91: AUV REMUS 6000

The wreckage was discovered on 2 April 2011 with the aid of the REMUS AUV's side scan sonar adjusted to a frequency of 120 kHz and a 700-metre range.

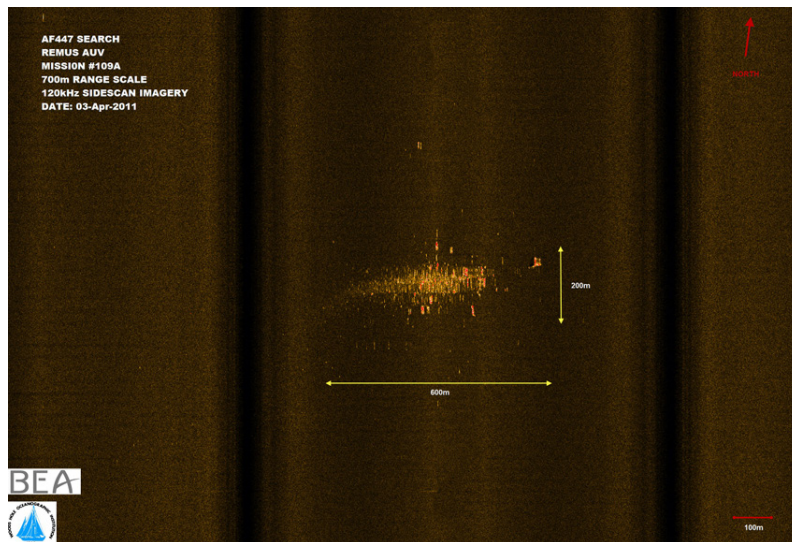

Figure 92: General view using sonar imaging: 120 kHz, range of 700 m

The first passage brought to light a concentration of backscattered data over an area of around 600 metres by 200 metres.

During the course of the following mission, the REMUS was programmed to take photos in bursts at a height of around ten metres to formally identify the wreckage of flight AF 447.

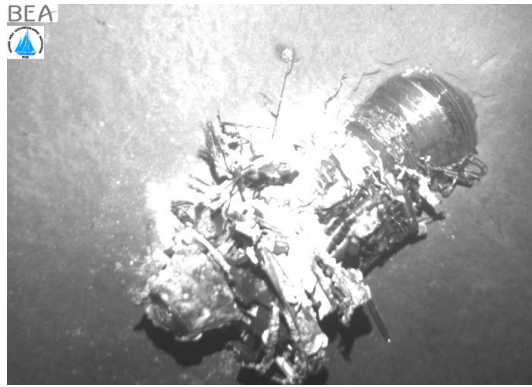

Figure 93: Engine



Figure 94: Wing



Figure 95: Section of fuselage



Figure 96: Landing gear

During phase 4, the area was scoured several times by the REMUS AUVs with different sonar settings to make sure that no possible debris, located beyond the main zone, was forgotten. This exploration made it possible to localize a part of the fuselage about two kilometres from this zone as well as objects such as oil drums that did not come from the aircraft (see the following figure). The initial imagery was subsequently enhanced by high resolution 410 kHz sonar images at various range scales.

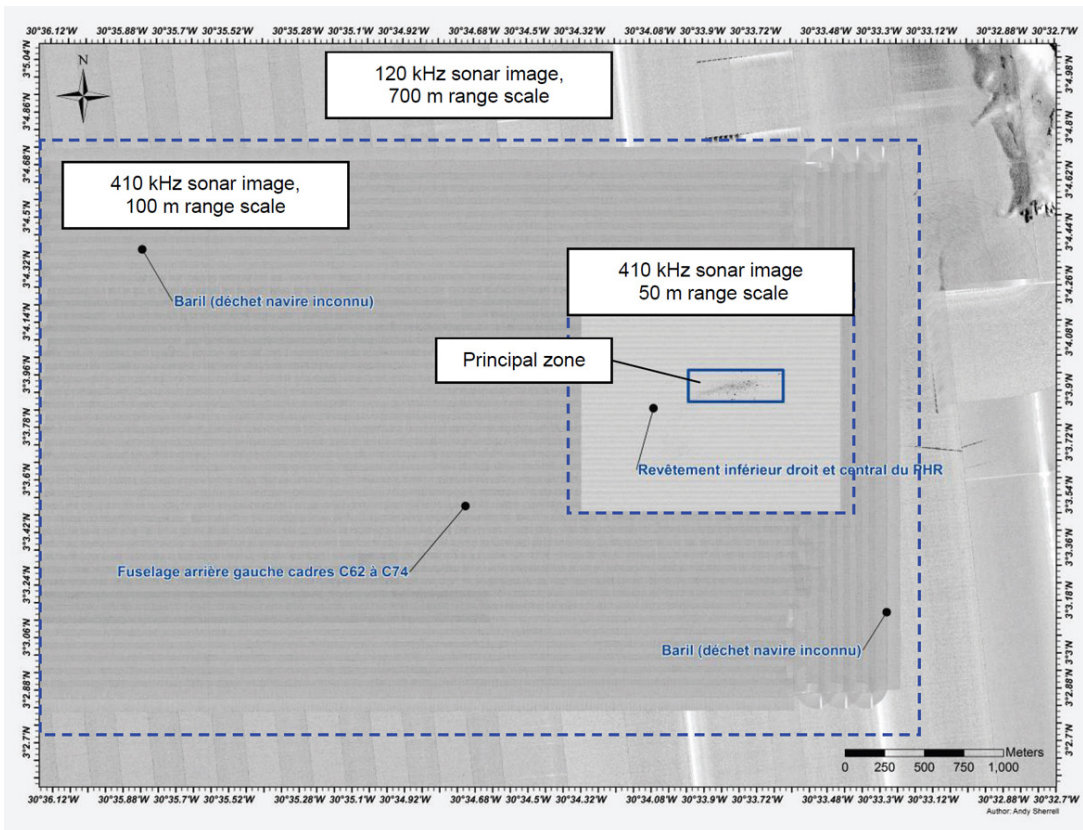

Figure 97: Overlay of sonar images taken with various settings:
120 kHz, 700 m range scale - 410 kHz, 100 m range scale - 410 kHz, 50 m range scale

These representations of the wreckage site were also enhanced and completed by photographs, taken by the REMUS AUVs at a height of about ten metres above the seabed.

These photos were taken from intercepting axes in order to pass over each piece of debris several times, in different directions. A total of around 85,000 photographs were taken in this way.

These photographs enabled the first chart of the wreckage site to be produced in mosaic form (see diagram below).

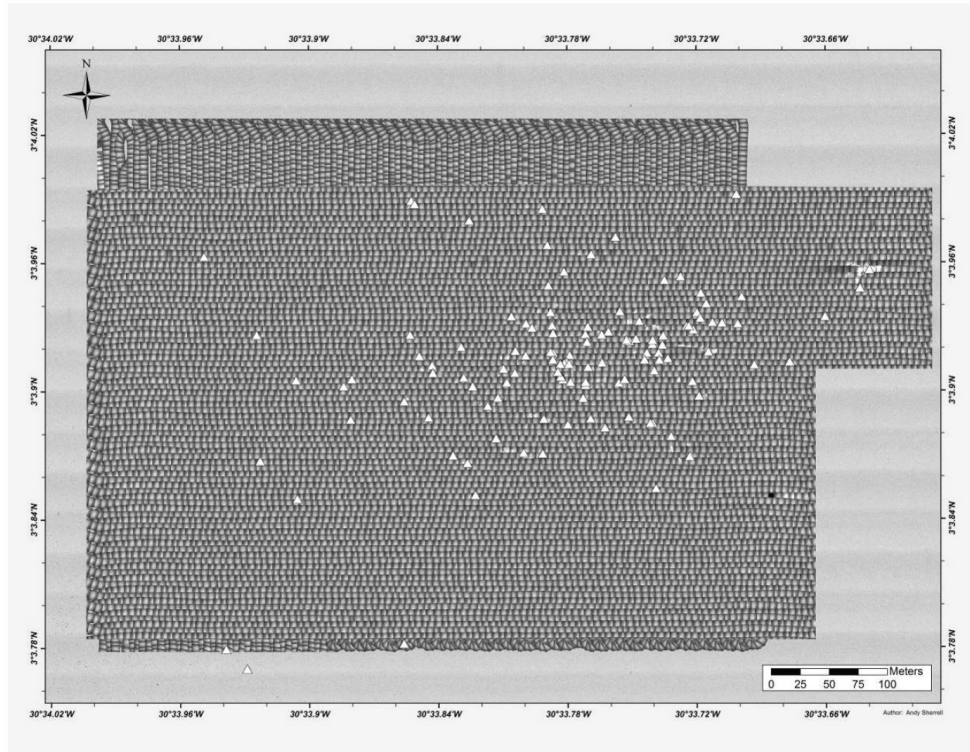

Figure 98: Visualisation of the photo mosaic obtained with REMUS AUV images and the aeroplane debris identified by using the REMORA ROV

The resources used during phase 4 helped the BEA to save a considerable amount of time in the following phase, especially the photos of the wreckage. The investigators thus had a complete two-dimensional representation of the crash site based on high resolution side-scan sonar images and photos before working on site with an ROV. These photos proved very useful for both preparing phase 5 and then conducting operations on site. They would have provided even more information if they had been in colour.

1.19.2 Resources used for phase 5

Phase 5 was carried out in two parts:

- The first part was dedicated to the search for and recovery of the recorders as well as other aeroplane parts. This was done on site from 26 April to 13 May 2011;
- The second part involved mapping the site and its surroundings and the recovery of the bodies. These operations lasted on site from 21 May to 3 June 2011.

To accomplish these tasks effectively, the BEA selected Alcatel Lucent and Louis Dreyfus Armateurs cable vessel the Ile de Sein, which was equipped with the Phoenix International Remora III ROV (Remotely Operated Vehicle) capable of working at a depth of 6,000 metres.

2 - ANALYSIS

2.1 Accident Scenario

This part is mainly based on the results of the work of the Human Factors group, whose approach is described in paragraph 1.16.8.

2.1.1 From the beginning of the CVR recording until the autopilot disconnection

2.1.1.1 Safety expectations

In a situation analogous to that which preceded the accident (cruise in the area of the ITCZ⁽¹⁹⁾, the aeroplane is in autopilot. Crews generally just undertake confident monitoring of the flight path and the automated systems due to their level of performance and reliability. Their preoccupations are above all centred on tactical and strategic aspects of navigation and fuel management.

⁽¹⁹⁾Inter-tropical convergence zone.

The risk model in the mental representation of the situation by crew members contains:

- ❑ **As a top priority**, the risk associated with crossing the ITCZ and consequently with turbulence, and perhaps with icing. The ITCZ is a zone that may be difficult to cross, and the crossing strategy depends as much on knowledge of the aeroplane (management of meteorological radar and knowledge of limitations and performance for example) as on the changes in the ITCZ itself (vertical development and horizontal movement). This strategy implies flight management that may require decision making, such as avoidance or a change of flight level;
- ❑ **A second risk**, doubtless far behind the first in the scale of perceived priorities, associated with the risks of loss of HF contact with ATC, of mid-air collision, of triggering an alert phase and of not being able to declare a need for a diversion and/or storm cell avoidance;
- ❑ A third risk present in the communications exchanged by the crew and linked to the management of a possible diversion and to the arrival conditions (for example, accessibility of alternate aerodromes for a diversion in the event of pressurisation or engine failure etc.);
- ❑ Lastly a **set of risks** grouping together all the possible problems and malfunctions on board, in the cockpit or cabin, and in the environment, the air mass or on the ground. This fourth group was not expressed verbally in the recorded communications, or any specific action. It is always present in the background of a pilot's cognitive activity, and is expressed by a visual/attention circuit which may not be recorded by current equipment.

The management of the first three areas of risk needs active handling of the action plan underway, that's to say by preoccupations and occupations: search for information (example adjusting the radar), thinking, calculations, evaluations, judgements, decisions, communications between crew members, possible actions on the flight path targets. The management of the fourth group of risks is performed by monitoring various marker parameters, signals and corresponding warnings. It remains passive until detection of an anomaly, which will trigger the appropriate active response by rapidly reorganising the action plan around new priorities.

From a CRM point of view, resource management within crews is ensured in particular through communication, listening and the recognition of the contributions of all crew members. The organisation of the cooperation between the crew members, as well as of the explanations on the tactical and strategic decisions, guarantee an adapted management of all crew resources. Captains must take the measure of these aspects and their leadership should enable the clear distribution of tasks and functions to be maintained at all times, even more so when crews are augmented.

2.1.1.2 Cruise and crossing the ITCZ: perception and management of the operational risk

We do not know what images of the meteorological situation the crew had on the ND, which are not recorded. However, it can reasonably be inferred from the satellite image of the situation to be crossed that the crew was faced with information calling for at least active monitoring and tactical adjustments to the navigation to avoid the storm centres, as other crews who were in the same zone at the same time were able to do.

In fact, the risk associated with the crossing of the ITCZ was discussed several times by the crew. In particular, from 1 h 45 to 2 h 00, the Captain and the PF noticed that they were entering the cloud layer and discussed the strategy to adopt. To avoid flying in the cloud layer while crossing the ITCZ and therefore to limit flight in the turbulent conditions that he mentioned several times⁽²⁰⁾, the PF wanted to change flight level and fly above the cloud cover, while recognising that it was not possible for the moment to climb two levels. He made several allusions or suggestions on the flight levels and the temperature from 1 h 35 min 20 onwards. He even considered requesting a non-standard level 360. His various interventions in the minutes that preceded the autopilot disconnection showed a real preoccupation, beyond the simple awareness of an operational risk. Some anxiety was noticeable in his insistence.

The Captain appeared very unresponsive to the concerns expressed by the PF about the ITCZ. He did not respond to his worry by making a firm, clear decision, by applying a strategy, or giving instructions or a recommendation for action to continue the flight. He favoured waiting and responding to any turbulence noticed. He vaguely rejected the PF's suggestion to climb, by mentioning that if "we don't get out of it at three six, it might be bad". He certainly meant that if the aeroplane was still in turbulent conditions at FL360, the margins for manoeuvre would be further reduced. Nevertheless, the REC MAX level was then above FL370 which guaranteed some margin for manoeuvre at this level (see paragraphs 1.16.12 and 1.16.5.7). It was usual at Air France to allow a certain margin in relation to REC MAX, which is likely the reason the crew did not envisage climbing to FL370.

The Captain neither expressed nor explained his position clearly. He seemed to have good experience of the ITCZ, and did not appear personally worried (at worst he expected to be disturbed by the turbulence during his rest). He noticed the turbulence and observed the St. Elmo's fire. But it seemed that having seen the information available on the radar, he deemed the appearance of the ITCZ crossing to be "normal".

As we do not have the radar image which was provided by his ND, it is difficult to assess the Captain's appraisal. But the aeroplane had not encountered, before or during the accident, an exceptional meteorological situation from the point of view of phenomena that are traditionally avoided in stormy environments (turbulence,

⁽²⁰⁾In cruise, the main risk associated with turbulence is the risk of injuries to crew members and passengers. Turbulence is essentially a problem of comfort that can disrupt the service, the passengers and the crew members that are resting.

lightning, icing). Even if the crews of flights before or after flight AF 447 made sometimes considerable detours of the zone, the crew of flight AF 447's crossing of a convective area at 1 h 50, where the level of turbulence was acceptable, (see 1.11.2) may have supported the Captain in his decision not to deviate from the flight path. The recording of the load factor showed that the turbulence remained light. It is therefore probable that the radar image available was not alarming.

Note: When the PNF replaced the Captain, he noticed that the gain on the weather radar was set to "calibrated". It was thus likely that this was already the case before the Captain's departure.

At no point did the Captain consider (any more than the PF did, in fact) any lateral avoidance. Even then, he did not clearly explain his point of view. He gave the impression of not really wanting to be involved in the decision, and of considering that, given the globally "normal" nature of the situation, choices would be made later and would only be tactical (example: lateral avoidance of a storm cell), and that he could transfer them to his crew during his rest period. Before leaving the cockpit, the Captain did not seem to have discovered that the crossing of the ITCZ was a concern for the PF. Some crews on flights that preceded or followed AF 447 made avoidance manoeuvres around the zone that were sometimes quite significant, but with different strategies. In several cases, avoidance took place after encountering a zone of moderate or severe turbulence, which was never the case for AF 447.

Note: Taking into account the discussions between the Captain and the copilot, the lack of any decision to perform a lateral avoidance manoeuvre could not be explained by a fuel management problem.

The relief crew did in fact inherit some decisions to make. From 2 h 01, the PF mentioned the subject of the ITCZ, turbulence and the choice of flight level in his briefing to the co-pilot who joined him as relief for the Captain. From 2 h 04 to 2 h 08, after the Captain's departure, the two co-pilots discussed the ITCZ again. The PF repeated his idea of climbing to level 360, without doing so. Acknowledging this non-solution, he warned the cabin personnel of imminent turbulence. After changing the gain on the weather radar from "calibrated" to "max", the PNF then suggested as of 2 h 08 min 03 a route alteration, which the PF willingly executed. It seems that the image then obtained appeared sufficiently different as to require a change of strategy. From his arrival in the cockpit, the PNF gradually established his seniority and authority over the PF.

The risk of loss of speed information related to crossing a high density of ice crystals was never mentioned. Some incidents had been experienced by crews and information about them had been made available to pilots (see paragraph 1.17.1.5.3.3). However, this information was not sufficient to get crews to integrate the risks associated with the obstruction of Pitot probes in the management of threats in cruise.

2.1.1.3 Relief of the Captain

Given the programmed duration of flight and in accordance with the Air France Operations Manual and the regulations in force, the flight crew was augmented by a co-pilot to enable in-flight rest periods, guaranteeing sufficient crew availability. This augmentation specifically enabled the Captain to take an in-flight rest by designating a rated co-pilot as relief pilot. This obviously implied the possibility of delegating

operational decisions to him, and the airline guidelines mention this clearly: "The relief pilot is the Captain's replacement. In his absence, he makes the operational decisions necessary to the conduct of the flight according to the instructions left by the latter". It should be noted that in case of a failure, the presence of a Captain in the cockpit is not guaranteed, and nor is the presence of the two pilots.

2.1.1.3.1 Choice of time period

The time period chosen by the Captain for his in-flight rest resulted in him leaving the cockpit at the start of the ITCZ crossing, leaving the two co-pilots to handle this crossing. This choice could be contested, without necessarily calling into question the principle of a relief co-pilot and the trust that this implied in the co-pilots. The ITCZ is in fact a specific environment that confronts flight management with very dynamic situations with high levels of uncertainty. Although thousands of crossings of the ITCZ are carried out without incident each year, it remains one of the moments in a flight where all the crew's attention is required, and where a captain's experience is an undeniable plus. The choice of in-flight rest time made by the Captain of flight AF 447 is however understandable considering the following:

- ❑ For him, the ITCZ crossing appeared "normal" in relation to the known risks, given the information available;
- ❑ The co-pilot in the left side seat was three times more experienced with both the aeroplane and South American trips than the Captain himself, even though he was not designated as relief pilot;
- ❑ The time period for in-flight rest chosen was that commonly used by most of the other Captains in the airline.

On the strategic level, one might question the relevance of the "collective" practice that leads Captains to choose, as their in-flight rest period, a time that could correspond to crossing the ITCZ: waiting until this zone has been crossed would only have delayed the start of the Captain's rest period by about fifteen minutes

2.1.1.3.2 Choice of relief pilot

The investigation was not able to determine if the Captain had clearly defined the roles between the two co-pilots during flight preparation and in anticipation of his absence during his in-flight rest time. He did however implicitly designate as relief pilot the co-pilot in the right seat and PF, but did so in the absence of the second co-pilot, just before waking him. If this distribution of roles probably contained no ambiguity for the persons concerned, being in line with the principle in the Operations Manual (co-pilot as relief Captain and PF on the right), it was not however free of difficulty. Indeed, the overall experience and on type of the PF, designated implicitly as relief Captain, was significantly less than that of the PNF, also OCC executive of the airline and as such enjoying recognition as an expert by his peers.

The Captain's question to the PF ("you're a PL, aren't you?") suggested that he had not thought about his relief for this flight until that moment. We might therefore question his designation as relief Captain instead of the PNF.

A natural assertion of authority by the PNF is then observable: he seemed to master the environmental context better (ozone) and suggested, even asserted, the avoidance strategy. The PF did not resist this tendency. Without this leading to the

slightest conflict, after the autopilot disconnection, it rapidly led to the inversion of the normal hierarchical structure in the cockpit, with leadership passing to the PNF in the left seat without the role of command being formally and explicitly transferred.

2.1.1.3.3 Handover arrangements

During the handover, before leaving the cockpit, the Captain did not perform the planned briefing himself. However, he was present in the cockpit during the briefing that the co-pilot in the right seat made to the co-pilot who came to the cockpit at 1 h 59 min 30 and sat in the Captain's seat. In his briefing, the PF mentioned the points listed by the Air France Operations Manual:

- The presence of previous and future turbulence;
- The fact that they were flying through clouds;
- That they could not climb because of the higher temperature than expected and therefore a REC MAX "a little too low";
- The HF contact with the Atlantico centre and the logon failure with the Dakar centre;
- The contact made with dispatch.

During this briefing the Captain recalled the Dakar HF frequencies when requested by the PF. Although he did not formally carry out the briefing himself, one can see that the objective of correct transmission of information to the relief pilot was reached. However, the Captain did not explicitly designate his relief in the presence of the two co-pilots, nor did he leave specific instructions for the ITCZ crossing. In particular, he did not make any judgements on the meteorological situation which was going to be encountered during the ITCZ crossing, and left no instructions concerning the tactics for crossing the ITCZ, nor on the PF's wish to climb.

2.1.2 From the autopilot disconnection to triggering of the STALL 2 warning

Note: To avoid any ambiguity in the following text, the triggering of the stall warning at 2 h 10 min 10 for three seconds is referred to as « STALL 1 warning ». The warning triggered at 2 h 10 min 51, is referred to as « STALL 2 warning ».

2.1.2.1 Safety Expectations

The autopilot disconnection must lead to priority being given to regaining manual control by the PF and the PNF monitoring in order to ensure control of the aeroplane and monitoring of the flight path defined by the crew.

In addition, the management of speed indication-related anomalies must generate a response, in a given period of time, which involves identifying the situation and applying the appropriate procedure. Furthermore, to ensure that expectations of the crew are satisfied, a number of conditions must be met:

- The signs of the anomaly should be salient;
- Information relating to the anomaly or to the diagnosis should be displayed and identified;
- The memory items associated with awareness of an airspeed indication anomaly should be known;
- Information to assist in understanding the situation should be provided.

2.1.2.2 Detection of a problem

Before disconnection, the autopilot maintained the aeroplane's flight path by countering light to moderate turbulence; the autothrust had a slight reduction to adjust the cruise mach towards the value selected on the FCU of 0.80.

The first disturbances in speeds 1 and 2 occurred at about 2 h 10 min 04, causing the autopilot to disconnect, which was signalled by a visual and an aural (cavalry charge) warning. The crew did not necessarily perceive these transient losses of speed information and the associated losses of altitude.

The first prolonged drop (at least 5 seconds) in speed on the right-side PFD began not later than 2 h 10 min 07. It caused a drop in the altitude displayed on this PFD of approximately 330 ft. From 2 h 10 min 08, the speed became abnormal on the left.

Since the salience of the speed anomaly was very low compared to that of the autopilot disconnection, the crew detected a problem with this disconnection, and not with the airspeed indications. The crew reacted with the normal, learned reflex action, which was to take over manual control (indicated by the PF's call-out "I have the controls", acknowledged by the PNF). For the same reasons relating to salience, it is likely that the crew had not yet perceived the reconfiguration to alternate law and the disconnection of the A/THR.

It was thus the autopilot disconnection that made the crew aware that there was a problem. The crew, at this time, did not know why the AP had disconnected and the new situation that had suddenly arisen clearly surprised the pilots – a normal reaction for any crew. This degree of surprise can be explained by the contrast between the triggering of a warning and the situation in the cruise phase, during which the pace of change tends to be slow and concentration levels are lower. In addition, the crew's mental resources were already taken up by turbulence avoidance manoeuvres and the plan to climb during the minutes that preceded the autopilot disconnection. Associated with the environmental conditions (smell of ozone that the PF did not seem to recognise and the noise due to the ice crystals), the PF's attitude in the minutes that preceded the autopilot disconnection probably constituted a factor that significantly added to the highly charged emotional factors during the sudden and unexpected change in the situation, at night and while passing through the ITCZ, which suddenly confirmed his vague concerns about it. Three seconds after the autopilot disconnection, surprise was a pilot's natural reaction and cannot be considered as specific to this crew.

From the moment the crew detected a problem, making an action plan should have begun with the definition of the flight path to follow, before application of any procedure.

2.1.2.3 Control of the flight path

When the autopilot disconnected, the roll angle increased in two seconds from 0 to +8.4 degrees without any inputs on the sidesticks. The PF was immediately absorbed by dealing with roll, whose oscillations can be explained by:

- A large initial input on the sidestick under the effect of surprise;
- The continuation of the oscillations, in the time it took to adapt his piloting at high altitude, while subject to an unusual flight law in roll (direct law).

In addition, the deviation in roll may have been caused by the risk of turbulence that had preoccupied the PF in the minutes leading up to the autopilot disconnection.

Following the autopilot disconnection, the PF very quickly applied nose-up sidestick inputs. The PF's inputs may be classified as abrupt and excessive. The excessive amplitude of these inputs made them unsuitable and incompatible with the recommended aeroplane handling practices for high altitude flight. This nose-up input may initially have been a response to the perception of the aeroplane's movements (in particular the reduction in pitch angle of 2° associated with the variation in load factor) just before the AP disconnection in turbulence. This response may have been associated with a desire to regain cruise level: the PF may have detected on his PFD the loss of altitude of about 300 ft and loss of vertical speed of the order of 600 ft/min in descent. The excessive nature of the PF's inputs can be explained by the startle effect and the emotional shock at the autopilot disconnection, amplified by the lack of practical training for crews in flight at high altitude, together with unusual flight control laws.

Note: The TAM case described in paragraph 1.16.2 is a further illustration of the startle effect generated by discovering the problem.

Although the PF's initial excessive nose-up reaction may thus be fairly easily understood, the same is not true for the persistence of this input, which generated a significant vertical flight path deviation. The safety investigation has made it possible to exclude, with reasonable certainty, the explanation that the repeated nose-up inputs were caused by the PF's unsuitable flying position (examination of the adjustment of his seat showed that it was adjusted in a way that was adapted to his morphology). Examination of the FDR parameters indicated that during the flight controls check undertaken while taxiing in Rio-de-Janeiro, the roll inputs did not induce a pitch component. There remain a number of possible explanations:

- ❑ The crew's attention being focused on roll, speed or on the ECAM;
- ❑ The initiation, more or less consciously due to the effects of surprise and stress, of the action plan (climb) desired by the PF prior to the autopilot disconnection;
- ❑ The attraction of "clear sky", since the aeroplane was flying at the edge of the cloud layer;
- ❑ A saturation of the mental resources needed to make sense of the situation, to the detriment of aeroplane handling;
- ❑ The presence of turbulence that may have altered perception of aeroplane movements in response to his inputs.

Whether the PF's nose-up inputs were deliberate or not, there was no verbal expression of this to the PNF. At no time did the PF indicate his intentions or objectives with respect to the control and stabilisation of the flight path. Although the PF's various roll inputs indicate his intention to keep the wings horizontal, it is not possible to determine what the PF's target was in the longitudinal axis. Four seconds after the autopilot disconnection, the rapid increase in nose-up attitude resulted in the triggering of the STALL 1 warning. This warning only appeared to provoke a small aeroplane handling reaction from the PF. The PNF asked "What is that?" which may refer to the stall warning. It is possible that the PNF, faced with a short, truncated warning, did not identify it. However, rather than indicating his failure to recognise the warning, this question seems to mean that the PNF did not consider the warning to be relevant in the context of the fact that he was not necessarily aware of:

- ❑ The PF's significant nose-up inputs that generated an increased angle of attack;
- ❑ The relative proximity of a flight envelope limit;
- ❑ The reconfiguration to alternate law (which he only called out later): if he thought they were still in normal law, the warning could have seemed to be irrelevant.

From the previous events studied (see 1.16.2 and 1.16.8.4) it is clear that almost all the crews that heard the stall warning considered it to be surprising and irrelevant. These judgements may be explained by the lack of awareness of the margins in relation to the trigger threshold of the stall warning and by not knowing the triggering conditions of the warning, which are a function of the angle of attack and Mach.

It would also seem unlikely that the PNF could have determined the PF's flight path stabilisation targets. It is worth noting that the inputs applied to a sidestick by one pilot cannot be observed easily by the other one and that the conditions of a night flight in IMC make it more difficult to monitor aeroplane attitudes (pitch attitude in particular). In addition, a short time after the autopilot disconnection, the PF's statement that he had the controls and his reaction to the initial deviations observed (in particular in roll) may have led the PNF to change his action priorities. Identification of the failure appeared to become a priority over control and flight path monitoring. Consequently, he was unaware of the climb.

Control of the flight path does not correspond to what is expected. The amplitude of the actions may doubtless be explained by the highly charged emotional factors generated by the unexpected autopilot disconnection in the context of the flight.

2.1.2.4 Identification of the situation

Once the first actions in response to the perceived anomaly is executed (returning to manual piloting following AP disconnection) and the flight path stabilisation ensured, the philosophy of both the manufacturer and the operator is for the crew to look for additional information necessary to understand the problem and take action. Three seconds after the autopilot disconnection, the ECAM displays no information that is likely to point to a speed indication problem:

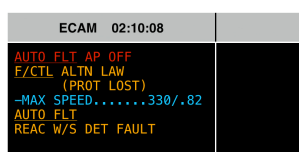

The ECAM mentions a maximum speed that should not be exceeded but does not mention a minimum speed. This could lead crews to suppose that the main risk is overspeed. In the absence of any reliable speed indication, this might lead to a protective nose-up input that is more or less instinctive. It should be noted that the reconfiguration to alternate law occurred because of the triggering of specific monitoring that is designed to react to events like icing of several Pitot probes (see the explanation of the PROBE PITOT 1+2 / 2+3 / 1+3 message in paragraph 1.16.2.4 in the first Interim report). However, no explicit indication that could allow a rapid and accurate diagnosis was presented to the crew.

In theory, the identification of the situation is mainly up to the PNF and begins once the flight path is stabilised and/or secured. In the case under consideration, this identification began while the flight path may have appeared to have been

controlled but was not stabilised. The ability to identify the problem was then largely if not totally diminished by interference between monitoring the flight path and the identification of the failure.

The crew nonetheless built an initial mental representation of the situation about ten seconds after the autopilot disconnection, based on their identification of a speed indication anomaly. However, they did not specify how many speed sources⁽²¹⁾ were lost. The loss of airspeed indication was called out almost simultaneously by both pilots. However, their call-outs do not confirm beyond doubt that they had fully understood the situation. When the PNF stated “we’ve lost the speeds”, he could have been referring to the loss of indicated airspeed information or to the loss of information about the characteristic speeds. It is possible that the identification of an airspeed anomaly, also noted by the PF (“we haven’t got a good display of speed”), was prompted by the triggering of the STALL 1 warning. This may have drawn the co-pilots’ attention to the speed tape on their PFDs through the association between the stall and the speed parameter.

Identifying the loss of speed information could have prompted the crew to apply the “IAS douteuse” emergency manoeuvre, if they had considered that the safe conduct of the flight was “dangerously affected”, this condition being generally associated with avoiding a collision with the high ground or terrain. Training for this emergency manoeuvre in a flight phase at low altitude may reinforce this interpretation by crews. In addition, the study of events involving loss of speed indications in cruise tends to show that the emergency manoeuvre is never applied, so much so that the failure to perform this manoeuvre is not specific to the crew of AF 447.

Neither was the non-ECAM emergency procedure “Vol avec IAS douteuse/ADR Check Proc” called out. A call for this procedure must be sufficiently practised for it to become an automatic response to awareness of an airspeed indication anomaly, regardless of any need to construct a more elaborate understanding of the problem.

The ability to establish a link between an observed anomaly and a procedure, particularly when the anomaly is not displayed on the ECAM, is one of the objectives of training; this ability is also dependent on the frequency of occurrence of the particular anomaly and is improved by regularly providing crews with information about in-service incidents. However, the number and the type of manifestation (ECAM messages, speed changes, etc) linked to erroneous speed indications makes training and exhaustive information for pilots impossible (see also paragraph 1.17.1.4.2).

In the case of the accident, the crew did not associate the loss of displayed speeds and the associated procedure. This may be explained by the difference between the symptoms that appeared during the training session that they had followed a few months previously and those that appeared during the event. In particular, the high number of ECAM messages that the PNF called out should be compared with the absence of messages in the training session scenario.

In the absence of a constructed action plan, the dynamic management of a situation becomes reactive or even random, with no anticipation. The increase in the level of emotion, which reduces the ability to recall information, leads to a return to the simple and basic rules in executing tasks in an unexpected situation.

⁽²¹⁾It is not possible to know whether or not the crew could have determined the number of sources lost.

Thus, having identified the loss of airspeed information, the PNF turned his attention to the ECAM, undoubtedly in an attempt to refine his diagnosis and to monitor any actions displayed. He started to read the messages, and consequently called out the loss of autothrust and the reconfiguration to alternate law. The successive display of different messages probably added to the confusion experienced by the crew in its analysis and management.

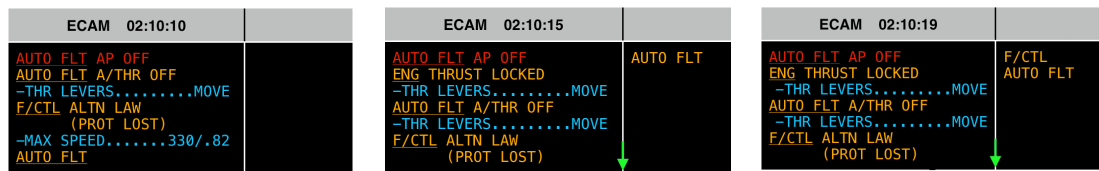

In the absence of a specific message expressing detection of unreliable speed by the systems, the crew was unable to identify any logical link between the symptoms perceived and these ECAM messages. The impression of an accumulation of failures created as a result probably did not incite the crew to link the anomaly with a particular procedure, in this case the “Vol avec IAS douteuse” procedure.

The disabling of the THRUST LOCK function by the PF indicates that he was searching for information. The PF may therefore have been overloaded by the combination of his immediate and natural attempts to understand the situation that was added to the already demanding task of handling the aeroplane.

Meanwhile, the PNF turned on the wing anti-icing system, after reading the ECAM, which suggests that at this point he may have considered there was a severe icing problem. The sound of ice crystals hitting the windshield, considered as rain by other crews, may have supported this perception of an associated risk.

The symptoms perceived may therefore have been considered by the crew as anomalies to add to the anomaly of the airspeed indication, and thus indicative of a much more complex overall problem than simply the loss of airspeed information.

2.1.2.5 Attempt to control the flight path

After reading the ECAM messages, which provided no apparent assistance to the crew, the PNF’s attention was drawn for a period of twelve seconds to the PF’s control of the flight path. The flight director indications reappeared on the PFD with a change of longitudinal mode to vertical speed, for the first time different from the cruise altitude track or capture mode. The crew never formalised this change of mode. The longitudinal crossbar first indicated a pitch-down order with which the PF’s inputs were consistent.

The PNF detected the climb based on observation and reasoning (“according to all three you’re climbing”), which indicates the beginning of a loss of confidence in the instrument readings. In particular, he asked the PF to stabilise, to pay attention to the airspeed and to descend. His instructions were imprecise insofar as they did not give the PF a firm objective (e.g. maintain altitude or adopt a specific pitch attitude); however, they do appear to have been essential and sufficient for a short-term management of the situation.

The PNF’s intervention prompted the PF to apply inputs that reduced the pitch attitude, which had exceeded 10 degrees. Although the PF agreed that the objective should be to lose altitude, his inputs maintained the aeroplane on an ascending flight

path. The crossbar then indicated a pitch-up input, which did not stimulate him to make sufficient pitch-down inputs to satisfy the PNF's request. On his side, the PF checked the position of the thrust levers ("We are in, yeah, we are in climb") then six seconds later reduced the thrust. It is possible that this thrust reduction was due to:

- ❑ Noticing that the thrust delivered was at maximum;
- ❑ His desire to avoid getting into an overspeed situation;
- ❑ His desire to reduce the aeroplane's rate of climb, or even to descend, as the PNF had requested a few seconds previously.

The PNF had noticed the need to stabilise the flight path, and the need for moderate aeroplane handling inputs. He probably considered that the reduction in pitch and the vertical acceleration sensed was a sufficient sign that the PF would correct the flight path to allow him to devote himself once again to identifying the failure.

2.1.2.6 Return to identifying the failure

Since no action or procedure had been displayed on the ECAM, the PNF took the decision unilaterally to set the AIR DATA selector to "F/O on 3".

It is possible that he had linked the loss of airspeed information on the right-side PFD to a loss of the ADR providing this information. In so doing, he may have been drawing on an analogy with one of the actions recommended in several procedures for dealing with an ADR⁽²²⁾ problem or icing⁽²³⁾. This action appears to show that the PNF was attempting to provide the PF with valid information. He also actuated the ATT/HDG rotary switch and called out this action ("I'm putting you in ATT... "). This change of inertial source, which with hindsight was not necessary, may indicate that his diagnosis of the failure was not completely defined. For him, the airspeeds indicated were inconsistent; he may not have excluded the possibility, however, that the inertial information was also inconsistent. In view of his doubts and the urgency of the situation, he may have thought it wise to change the two sources of information.

In any event, this change of inertial and speed source resulted in the involuntary lengthening the invalidity of the speed displayed on the PF's PFD, where the speed on the ADR 2 was on the point of becoming valid again.

After changing the ADR source, the PNF's "what is that" appears to indicate his total incomprehension faced with the result of this action, since the speed displayed on the right side was still erroneous. He appeared at this point to have been overwhelmed. Recalling the Captain to the flight deck became his top priority; his first attempt to call him occurred two seconds before the STALL 2 warning triggered.

It should be noted that, during this forty-six second period between the autopilot disconnection and the STALL 2 warning, the C-chord warning sounded for a total duration of thirty-four seconds, thirty-one seconds of which as a continuous alert, and the STALL warning sounded for two seconds. The C-chord alert therefore saturated the aural environment within the cockpit. It was not cancelled by the crew. This aural environment certainly played a role in altering the crew's response to the situation.

At 2 h 10 min 47, one of the crew members cancelled the Master Caution warning that had been active since 2 h 10 min 05, that's to say for more than 40 seconds. To do this he had pressed the push-button on the FCU, which was illuminated in amber at that time. At that moments, the C-Chord warning had been active for about 27 seconds.

⁽²²⁾NAV ADR 2 Fault, NAV ALTI DISCREPANCY, and NAV IAS DISCREPANCY procedures.

⁽²³⁾Anti Ice F/O PROBES HEAT, Anti ICE F/O PITOT or L(R) STAT or AOA HEAT procedures.

This warning is cancellable by pressing the Master Warning push-button, which is not illuminated, located just next to the Master Caution push-button.

It is possible that this action of pressing the Master Caution was a reflex action to the fact that the button was illuminated. It is however also conceivable that this was done with the intention of cancelling the C-Chord warning in order to relieve the saturated aural background in the cockpit.

In general, the failure of both crew members to formalise and share their intentions made the identification and resolution of the problem more difficult.

2.1.3 From the triggering of the STALL 2 warning until the end of the flight

2.1.3.1 Safety Expectations

When the angle of attack protections provided by the normal flight control law are no longer available, the approach to stall is indicated to the crew by:

- The aural "Stall" warning, associated with the MASTER WARNING indicator light;
- The appearance of the red and black strip on the speed tape (Vsw);
- Buffet.

When the calculation of the Vsw speed is not available, this speed is no longer displayed on the PFDs. No visual information is then displayed that is specific to the approach to stall⁽²⁴⁾.

The aural characteristics of the warning (a synthetic voice saying "Stall, stall" and the cricket), or the "deterrent buffet" vibrations, are thought to be so intrusive that they will make the crew realise that their understanding of the situation is mistaken, and will call their attention to the fact that the aeroplane is approaching the limits of the flight envelope.

The perception of one or both of these signals must prompt PF's to recall the overall model associated with the stall phenomenon:

- Identification of the warning or buffet (i.e. making sense of the perceived signals);
- Acceptance of the diagnosis of a stall, which involves acknowledging the credibility of the signals in a situation in which they are unexpected;
- Recollection and application of an associated procedure, the underlying principles of which are taught in the first few hours of basic pilot training.

It is also expected that PNF's identify the signs of the approach to stall, that they accept the associated diagnosis, and that they check that the PF's' inputs are correct.

The crews' expected reaction time is of the order of a few seconds. Examination of the documentation has not brought to light a technical call-out associated with the implementation of actions.

Other than during initial training, as mentioned above, a pilot is unlikely to encounter an approach to stall more than a few times during his or her career, and is even less likely to have to deal with a fully-developed stall. The safety model thus assumes that the abilities to identify the signals indicative of the approach to stall, and to recall the expected actions, remain sufficient over time, despite the low levels of exposure.

⁽²⁴⁾The Master Warning pushbutton lights up, but does not constitute specific information about the approach of stall since it is associated with many emergency situations.

2.1.3.2 Exit from the flight envelope

The STALL 2 warning triggered at 2 h 10 min 51 but did not elicit any response from the crew. Even though the stall warning had been sounding for 9 seconds, the aeroplane climbed above the propulsion ceiling with the vertical speed still high, and with a flight path speed that was dropping as a result of this vertical speed. At this point, only descent of the aeroplane through a nose-down input on the sidestick would have made it possible to bring the aeroplane back within the flight envelope.

The rapid reduction in speed was accompanied by an increase in the angle of attack. The lift ceiling, at the Mach at which the aeroplane was flying at that time, was broken a few seconds after breaking through the propulsion ceiling. Due to its momentum, the aeroplane continued to climb: the aeroplane's kinetic energy was converted into potential energy until the point was reached when the aeroplane unavoidably started to descend. The PF was still applying nose-up inputs and the angle of attack continued to increase. Even with the engines at the TOGA thrust setting, the drag generated by this high angle of attack was so high as to prevent the aeroplane from accelerating.

Subsequently, the position of the sidestick, maintained in its nose-up or neutral position, continued to exacerbate the situation and made the recovery uncertain, even impossible.

2.1.3.3 Reactions of the crew to the stall warning

Four seconds before the triggering of the STALL 2 warning, the flight director crossbars reappeared on the PFDs. The vertical mode engaged was V/S mode with a target value of +1,400 ft/min. The modes displayed on the FMA were never called-out by the crew. The horizontal bar then indicated a slight nose-up order compared with the aeroplane symbol. The PF's nose-up input caused the increase in the angle of attack and triggered the stall warning. At the instant when the STALL 2 warning was triggered, at 2 h 10 min 51, the aeroplane's pitch attitude was 7 degrees, and increasing. A few seconds later, buffet started.

The crew never referred either to the stall warning or the buffet that they had likely felt. This prompts the question of whether the two co-pilots were aware that the aeroplane was in a stall situation. In fact the situation, with a high workload and multiple visual prompts, corresponds to a threshold in terms of being able to take into account an unusual aural warning. In an aural environment that was already saturated by the C-chord warning, the possibility that the crew did not identify the stall warning cannot be ruled out.

2.1.3.3.1 PF's reactions

Even if the PF's acceptance (or rejection) of a stall diagnosis was never verbalised, even though some of his actions could be considered to be consistent with those recommended in an approach to stall situation: setting the thrust levers to the TOGA detent, or his concern with keeping the wings horizontal. On the other hand, in the absence of airspeed information known to be reliable, it is possible that the PF thought that the aeroplane was in an overspeed situation, notably due to his interpretations of several clues:

- ❑ The aerodynamic noise,
- ❑ The buffeting, that he might have interpreted as being due to high speed,
- ❑ The speed trend arrow on the PFD, which at that time indicated acceleration.

Some of the PF's actions may be interpreted as indicative of a perception of a risk or of a diagnosis of overspeed. Firstly, the PF reduced the thrust during the seconds preceding the activation of the STALL 2 warning and the onset of buffet. Secondly, 51 s after the triggering of this warning, the PF said "I have the impression we have speed" then moved the thrust levers to the IDLE detent. He reformulated his impression a few seconds later, combined with an attempt to extend the speedbrakes.

Other factors which may have prompted the PF to fear an overspeed situation were:

- ❑ The display on the ECAM (max speed 330/.82) combined with the reconfiguration to alternate law which may have been read;
- ❑ The fact that, in cruise, the upper red strip on the speed tape (MMO) is about ten knots above the current speed, whereas VLS is barely visible at the bottom of the tape (thirty knots less);
- ❑ The dangers associated with overspeed situations embedded in the collective consciousness of pilots.

Nevertheless, the PF was also confronted with the stall warning, which conflicted with his impression of an overspeed. The transient activations of the warning after the autopilot disconnection may have caused the crew to doubt its credibility. Furthermore, the fact that the flight director was advising a nose-up attitude may have confirmed the PF's belief that the stall warning was not relevant. During previous events studied, crews frequently mentioned their doubts regarding the relevance of the stall warning (see 1.16.8.4).

The application of maximum thrust was probably the consequence of the perception of the stall warning. However, the PF may have assimilated the triggering of the warning as a consequence of the reduction in thrust, which he had applied four seconds earlier; he should then have applied full thrust to return to the earlier situation.

A few seconds later, the PF said "I'm in TOGA, right?". Either he was unsure whether or not he had set the thrust controls to the TOGA detent, as he intended, or he did not understand why this action was ineffective in clearing the stall warning. This second case might therefore indicate that the PF had built an erroneous mental representation of the aeroplane's flight model, and that he had hoped that he could resolve the situation by applying TOGA thrust at high altitude and a pitch attitude of twelve degrees, a strategy similar to that recommended at low altitudes. The fruitless result of his actions possibly heightened his mistrust of the warning.

Finally, although the PNF had called out the reconfiguration to alternate law when reading the ECAM, and even though the indicators of the loss of protection should have been displayed on the PFD (SPD LIM and an amber cross in roll and yaw), it is possible that the PF was not fully aware of this reconfiguration and of what it implied. He may therefore have embraced the common belief that the aeroplane could not stall, and in this context a stall warning was inconsistent.

The pitch attitude oscillations, in the seconds following the activation of the stall warning, reveal that the handling of the aeroplane was clearly very difficult and probably demanded the PF's full attention. During this phase, the aeroplane symbol on the PFD was close to, but on average slightly above, the flight director horizontal bar.

The PF likely attempted to track this crossbar as it changed without having integrated the change of longitudinal engaged mode. Indeed, the charged emotional factor combined with the workload prompted the PF to trust the flight director, independently of any other parameter: he may have considered the flight director crossbars as means of maintaining the cruise level.

Moreover, the flight director displays could have prompted him to command a positive pitch angle, of about 12.5°. This value appears in the stall warning procedure for the take-off phase. It is possible that, even though he did not call it out, the PF had recalled this memorised value and then had clung to this reference without remembering that it was intended for a different flight phase. The conjunction of this remembered value and the flight director displays may have constituted one of the few (and maybe even the only) points of consistency in his general incomprehension of the situation

Thus, it seems likely that the flight director exerted an influence. The PF could have been tempted to adhere to it without validating the information presented. The concurrence of the information from the FD with the stall warning may have undermined the credibility of the actions to take in response to the warning.

Note: The "Vol avec IAS douteuse" procedure recommends disabling the FD, to prevent it from presenting cues that could potentially be irrelevant.

The flight director displays, the doubt regarding the relevancy of the aural stall warning and the identification of the possibility of an overspeed situation did not allow the PF to make a correct diagnosis. He therefore implemented a combination of antagonistic actions to respond to both an overspeed situation (reduction in thrust, nose-up inputs) and to a stall situation (application of maximum thrust).

2.1.3.3.2 PNF's actions

When STALL 2 warning triggered and buffet appeared, the PNF was faced with an increasing incomprehension of the situation.

The PNF's strategy was then above all to call the Captain, which occupied a large part of his resources. Since he was anxiously waiting for him to return, it is possible that the phenomenon of attention selectivity reduced his ability to perceive the STALL warning.

If he had in any event perceived the approach-to-stall situation and taken into account the flight path corrections in the previous sequence, it would seem astonishing that the PNF's primary concern would be that of keeping the wings horizontal then checking the engines' thrust setting. He too may have doubted the reliability of the warning.

Whatever the case, the PNF's attention was distracted from the key parameter at that time, that's to say the aeroplane's pitch attitude, which was inappropriate at that altitude.

At about 2 h 11 min 38, after the PF said "I don't have control of the plane at all", the PNF called out "controls to the left", took priority and made two lateral left inputs to the stop. The aeroplane was then rolling to the left. The PF immediately took back priority and kept his sidestick at the stop to the left. This priority takeover by the PF could not be explained but bears witness to the de-structuring of the task-sharing.

2.1.3.4 Return of the Captain

The Captain certainly noticed the vibrations linked to buffet as well as the pitch attitude of about 15 degrees, and heard the stall warning while he was approaching the cockpit. Nevertheless, on his return, he made no reference to this. The stall warning became intermittent and interwoven with the C-chord alert. These two warnings, combined with the ambient noise and the voices of his colleagues, made a saturated aural environment, which was difficult for the Captain to understand, especially since some of his attention was certainly focused on reading and analysing the instruments.

The two co-pilots informed him that they had lost control. The PNF stated that he did not understand the situation and that they had "tried everything". The general incomprehension made it difficult to give a more precise description of the recent events. When the Captain returned to the cockpit, the aeroplane was in a rapid descent, though at an altitude close to the cruise level it was at when he had left. Under these conditions, and not having experienced the complete sequence of events, it was very difficult for the Captain to make a diagnosis. He would have needed to question the co-pilots about the sequence of events, an approach that was blocked by the urgency of the situation and the stress conveyed by the PNF's tone of voice.

Subsequently, his interventions showed that he had also not identified the stall: the multiple starts and stops of the stall warning certainly contributed to make his analysis of the situation more confused. He then seemed to have based himself on the pitch attitude and thrust parameters to analyse the flight path.

2.1.3.5 End of the flight

At about 2 h 12, descending though FL 315, the aeroplane's angle of attack was established around an average value of about 40 degrees. Only an extremely purposeful crew with a good comprehension of the situation could have carried out a manoeuvre that would have made it possible to perhaps recover control of the aeroplane. In fact, the crew had almost completely lost control of the situation.

Up until the end of the flight, no valid angle of attack value was less than 35°.

2.2 Pilot Training and Recurrent Training

2.2.1 Manual aeroplane handling and functional representation of flight

At 2 h 10 min 05, when the autopilot disconnected, the aeroplane was flying in cruise close to the upper limit of its flight envelope, autothrust was trimmed back slightly to adjust the cruise Mach to the value requested by selecting 0.80 on the FCU.

In the first minute after the disconnection of the autopilot, the aeroplane exited its flight envelope. Neither of the two crew members had the clarity of thought necessary to take the corrective actions. However, every passing second required a more purposeful corrective piloting input.

After autopilot disconnection the nose-up inputs produced a load factor of up to 1.6 g, that's to say 1.4 g if the turbulence component is excluded. Maintaining a high pitch attitude first resulted, when the aeroplane had sufficient speed, in a fast climb speed (up to 7,000 ft/min) and then in a rapid increase in the angle of attack. At high altitude, such a high climb speed can only be achieved by converting kinetic energy to potential energy, that's to say at the expense of a rapid decrease in flight path speed.

In addition, the thrust value of 84% N1 was lower than the thrust necessary for level flight (95% N1) due to the reduced mach ordered a few seconds before the autopilot disconnection, then the change to "Thrust Lock" mode at 2 h 10 min 10. The thrust was readjusted towards CLIMB at 2 h 10 min 23 even though the aeroplane was already climbing rapidly with a vertical speed of 6,000 ft/min.

These factors induced a rapid reduction in the kinetic energy and brought the aeroplane above its lift ceiling, at the Mach level at which it was then flying. This rapid exit from the flight envelope was not understood and thus not anticipated by the pilots.

In the absence of reliable speed indication, an understanding of the physics of high-altitude flying, gained through training in the fundamental principles of energy conversion, equilibriums of forces, and lift and propulsion ceilings, could have considerably helped the pilots to anticipate the rapid deterioration in their situation and to take the appropriate corrective measure in time: initiate a descent.

It should also be noted that overspeed was a strong risk in the PF's mind. This was the consequence of the fact that, in theoretical teaching (notably ATPL), the risk of "high speed stall" is presented equally with the more classic "low speed stall". Even though the latter is quite well known to pilots, excursions beyond VMO/MMO are not demonstrated in training. Furthermore, vibrations (linked to buffet) are erroneously associated with overspeed.

Air France's Aeronautical Manual (MAC) describes in great detail, over 38 pages, the physics of high-altitude flight with real cases. This knowledge is also included in the theoretical teaching that is supposed to be provided at an advanced stage in the training of a future airline pilot (ATPL theory, type rating performance). The climbing flight path that was initially more or less deliberate on the part of the crew is likely a clue to the insufficient assimilation of these theoretical notions.

2.2.2 CRM training and exercises

The task-sharing by the two co-pilots appears to have been well defined, beginning with their initial reactions to the autopilot disconnection: the PF concerned himself with handling the aeroplane, and the PNF with dealing with the failure. By identifying that speed information had been lost, the two co-pilots were able to define a shared representation of the situation. However, this was not sufficient to enable them to construct a joint action plan to manage the situation. The PNF's reading of the ECAM messages, in a broken and hesitant manner, may have drawn the PF's attention to the ECAM, to the detriment of the piloting task. With the exception of the PNF's intervention on the control of the flight path, the two co-pilots failed to communicate, in a clear and precise manner, the intentions and objectives that motivated the tasks they performed. Better communication would have resulted in closer coordination. Faced with the difficulties of managing the situation, the two co-pilots fairly quickly focused on their tasks to the detriment of communicating essential information to each other in an effective manner. The loss of coordination and the willing but chaotic cooperation in managing the surprise generated by the autopilot disconnection led quickly to the loss of cognitive control of the situation, and subsequently to the loss of physical control of the aeroplane.

Overall, CRM thus gradually deteriorated and the analysis of the event highlights its fragility in this context of unexpected and unfamiliar dynamic situations. CRM training courses are provided throughout the career of an airline pilot. Their objective is to develop the acquisition of non-technical skills (NOTESHS) required for the correct general functioning of a crew. Even though the regulations make mandatory a CRM evaluation during the annual line check and first pilot-in-command check, this evaluation faces the difficulty inherent in measuring CRM performance objectively.

The absence of a reference system and methodological heterogeneity and evaluation criteria amongst the instructors, whose performances were variable and not well harmonized, did not make it possible to evaluate and compare the crews' CRM skills objectively. This shortcoming could nevertheless be overcome by setting instruction standards that would allow objective evaluation and comparison of crews' CRM skills.

2.2.3 Augmented crews

The investigation did not bring to light any information that might reasonably call into question the strategic management of the flight path by the crew of flight AF 447 during its passage through the ITCZ, prior to autopilot disconnection. Analysis has not revealed any particular deficiency in the practical (or formal) transmission of information when the Captain was relieved, whose correction would have changed the course of subsequent events. However, the Captain did leave the cockpit for a rest period without having formally designated the PF as his relief, and without having replied to his concerns regarding the ITCZ and the turbulence. This contributed towards raising this co-pilot's charged emotion levels for the remainder of the flight: he found that he had been given all the responsibilities of a relief Captain, but did not feel that he had all the information needed to make the right decisions, with the second, more experienced co-pilot.

The crew of two co-pilots left in the cockpit after the departure of the Captain were left with an uncertain strategy for the next phase of the flight. Furthermore, the crew also had some characteristics that were unfavourable to good resource management.

Indeed, in terms of total experience and experience on this type of aeroplane, the PF, designated implicitly by the Captain as his relief, was significantly less experienced than the other co-pilot. The latter also held a managerial position within the airline at its Operations Control Centre and, it may be assumed, was accordingly considered as an expert by his peers. This raises questions about the rationality of designating this co-pilot as the relief Captain. The difference in experience between the two co-pilots resulted in the PNF naturally taking over. The PF did not oppose this tendency. Without this generating any conflict, this take-over led rapidly, after the autopilot disconnection, to the inversion of the normal hierarchical structure in the cockpit. The leadership role switched to the PNF, without the command function being formally and explicitly transferred.

The operator's training programme does not give co-pilots the opportunity to systematically develop the mindset needed to perform the role of relief Captain aboard flights with augmented crews. This lack of CRM training specific to the role of a relief Captain could impair the synergetic response of a crew consisting of two co-pilots. Such a crew may therefore be less well prepared and able to implement cooperative management of an unexpected situation in the mid- and long-term.

2.2.4 Flight simulators

With regard to practical training relating to the notion of a stall warning, the only opportunities available to the two co-pilots to learn about stall were during their basic training, and then as part of one or two simulator sessions during their initial training for A320 type rating. These exercises were conducted at low altitude (FL100) with the focus on demonstrating and analysing the phenomenon, and with particular attention on the operation of the aircraft's protections in normal law. In alternate law, the approach to stall exercise exposes the trainee to the stall warning in a situation in which it is expected, and the corrective actions to be performed are prepared in advance. The exercise lets the trainee experience the onset of the vibrations due to buffet, which confirms the stall phenomenon.

At high altitude, the margin between the normal angle of attack in cruise and the angle of attack that activates the stall warning is very small. Trainees who perform the exercise at low altitude note a reduction in speed compared with the reference values but are not sensitized to the proximity of the angle-of-attack threshold at which the warning is triggered.

The demonstrative nature of the exercises undertaken does not enable the crew to appreciate the startle effect generated by the stall warning, nor the reflex actions on the controls that may be induced.

Current training practices do not fill the gap left by the non-existence of manual flying at high altitude, or the lack of experience on conventional aeroplanes. Furthermore, they limit the pilots' abilities to acquire or maintain basic airmanship skills.

More generally, the exercises performed in a simulator follow a predetermined scenario, and even if there are variations from one session to the next, the trainees are more or less familiar with the failures they will have to deal with. In this respect, the training scenarios may significantly differ from the reality of an in-flight failure. The startle effect associated with this operational reality is destabilising and generates

stress. It may have a direct impact on the correct execution of a manoeuvre, or on the ability of a crew to diagnose the problem and then recover the situation. However, the conditions in which training is delivered are not conducive to giving instruction in these environmental factors, and thus to the subsequent application in service of the non-technical skills necessary for the correct management of an unexpected situation.

The crew of flight AF 447 did not link the disappearance of speed information and the various warnings and associated ECAM messages to the "IAS douteuse" procedure. The loss of airspeed information can occur for various technical reasons, in flight phases with differing risks generated. Consequently, it is complex to recreate in the simulator all the failure modes that lead to this situation.

Furthermore, this variability in failure modes produces very different effects in the cockpit. Indeed, the loss of speed information can be manifested by the triggering of a large number of warnings and ECAM messages, but also (as during crew training on a simulator) by a "simple" inconsistency of parameters, without any warnings.

The crews performed the training in compliance with a known scenario, but did not have the opportunity to consider the consequences of the startle effect on their individual behaviour, nor its potential to disrupt the ability of the crew to work as a team.

Thus the difficulty, or even the impossibility, of reproducing on a simulator both the complexity and variability of the failure signals, combined with the lack of a startle effect for a known scenario, prevented the training from being appropriate to the situation actually encountered.

2.2.5 Aeroplane behaviour in reconfiguration laws

Alternate 2B law represents a specific case of flight control law reconfiguration. In fact, it occurs when the flight control computers have rejected the three ADR's. It has the specific characteristic of being associated with the loss of computation and display of the limit speeds. The high and low speed protections that exist in normal law, and sometimes in a reduced manner (high and low speed stability) in alternate law, are lost. There is however no explicit indication, apart from the red SPD LIM flag next to the speed tape (on the ECAM for example), of the level of alternate law that the aeroplane is in. The ECAM message associated with the reconfiguration to alternate law, of whatever type, indicates "PROT LOST". However, not all of the protections are lost, since the load factor protection remains available, and reduced protections can also exist. The precise identification of the consequences of a reconfiguration in alternate law is thus complicated.

In alternate 2 law, the longitudinal control law remains a load factor law and the lateral control law is a direct law. In the specific case of alternate 2B law, some coefficients used in the longitudinal flight control law become speed-independent and are set for the maximum speed for the aeroplane configuration (330 kt in clean configuration). This hardly modifies the behaviour of the aeroplane in comparison to normal law, but can nevertheless induce an unusual response dynamic when the aeroplane has an abnormally low speed for the configuration. In relation to lateral control, the direct law implies that a pilot control input is necessary to counter any possible roll tendency (for example linked to a crosswind component). There is no aileron trim.

Thus, in case of autopilot disconnection in a zone with turbulence, as was the case during the accident flight, a pilot input, even if moderate, can quickly become necessary to control the roll. It appears in fact that maintaining the wings horizontal represents a basic piloting objective for an airline pilot, especially in a cruise situation. On the other hand, maintaining the load factor law according to the longitudinal axis makes it possible not to have to make inputs for the aeroplane is practically maintained in level flight. There must really be a high level of turbulence for the aeroplane to be significantly destabilized. Piloting inputs must therefore be moderate and essentially on the lateral axis. In the case of the accident, the PF tried to control the roll, even if the amplitude of his inputs finally maintained these movements. The relatively strong nose-up inputs that he applied at the same time may have, among other hypotheses, have originated in a certain difficulty in integrating the various types of control laws and thus the difference in the type of handling inputs to adopt between the two axes.

When there are no protections left, the aeroplane no longer possesses positive longitudinal static stability even on approach to stall. This absence specifically results in the fact that it is not necessary to make or increase a nose-up input to compensate for a loss of speed while maintaining aeroplane altitude. This behaviour, even if it may appear contrary to some provisions in the basic regulations, was judged to be acceptable by the certification authorities by taking into account special conditions and interpretation material. Indeed, the presence of flight envelope protections makes neutral longitudinal static stability acceptable.

However, positive longitudinal static stability on an aeroplane can be useful since it allows the pilot to have a sensory return (via the position of the stick) on the situation of his aeroplane in terms of speed in relation to its point of equilibrium (trim) at constant thrust. Specifically, the approach to stall on a classic aeroplane is always associated with a more or less pronounced nose-up input. This is not the case on the A330 in alternate law. The specific consequence is that in this control law the aeroplane, placed in a configuration where the thrust is not sufficient to maintain speed on the flight path, would end up by stalling without any inputs on the sidestick. It appears that this absence of positive static stability could have contributed to the PF not identifying the approach to stall.

2.3 Ergonomics

2.3.1 ECAM

At 2 h 10 min 05, in response to the obstruction of the Pitot probes by ice crystals, various monitoring mechanisms triggered almost instantaneously.

Thus, the FMGECs detected differences between the various speeds measured and the flight control computers (FCPC/PRIM) identified a sudden drop in several measured speeds, leading to the reconfiguration to alternate law. This monitoring, specific to the FCPCs, is designed to detect the obstruction of several Pitot probes.

The crew is only informed of the consequences of the triggering of these monitoring mechanisms: disconnection of the AP and of the ATHR, transition to alternate law etc. No failure message is provided that identifies the origin of these other failures: in particular, the rejection of the ADR's and of the speed measurements.

The crew thus took control of the aeroplane, some of whose systems had identified inconsistencies in the measured speeds, though no ECAM message enabled a rapid diagnosis of the situation to be made initiating the appropriate procedure. However, during their training and exercises, crews are told to read the ECAM as soon as the flight path has been controlled, since this should facilitate the analysis of the situation and allow them to organise a course of action to deal with the failures.

Between the autopilot disconnection and the triggering of the STALL 2 warning, numerous messages were displayed on the ECAM. None of these messages helped the crew to identify the problem associated with the anomalous airspeed. Furthermore, the management of the priorities of the various messages resulted in a rapid change-over of the information displayed, which further complicated the crew's analysis and understanding of the situation.

The reading of the ECAM by the PNF, and possibly also by the PF, was time-consuming and used up mental resources to the detriment of handling the problem and monitoring the flight path.

2.3.2 Operation of the flight directors

When an unreliable airspeed event occurs, the automatic control features (autopilot and autothrust) disconnected automatically. The crew could only then re-engage them by pressing on a dedicated push-button on the FCU. The flight directors behaved differently, insofar as the cross bars disappeared from the PFD, even though the flight directors were still engaged.

The consequence of such absence of an automatic disconnection was that the cross bars disappeared and reappeared several times as changes occurred in the various parameters used and their corresponding monitoring mechanisms, without requiring specific action of the crew. The disconnection of the flight directors is part of the "IAS douteuse" emergency manoeuvre (Air France) and in the "Unreliable airspeed" (Airbus) procedure, as are the autopilot and autothrust disconnection. This approach is probably prompted by the desire to avoid erroneous commands being issued, resulting from the loss of consistent airspeed information.

However, analysis of previous events shows that the AP and the A/THR always disconnected automatically⁽²⁵⁾. The flight directors always disappeared (at least temporarily) when the A/THR disconnected, but reappeared automatically when the operating conditions were regained, whereas the re-engagement of the AP or of the A/THR required action by the crew. This difference in behaviour between the AP and the A/THR on the one hand, and the FDs on the other, probably played a role in the accident as a result of the conjunction of several effects:

- ❑ The credibility of the cross bars is strengthened by their disappearance followed by their re-appearance: if they appear, it implies that the indications that they display are valid;
- ❑ Since they attract the crew's attention (green colour and presentation in the centre of the PFD), the presence of the cross bars could have influenced the actions of the PF, notably in respect to his reaction to the stall warning;
- ❑ It is only possible to be aware of the changes in active modes (when the cross bars reappear) by reading the FMA, which is probably difficult to do in a high workload situation induced by piloting or failure management tasks.

⁽²⁵⁾Except in certain cases, in which the crew had already disconnected the A/THR after entering a zone of turbulence.

One may therefore question the suitability of the automatic reappearance of the flight directors once they have disappeared.

2.3.3 Stall warning (operation and identification)

In alternate or direct law, the triggering threshold for the stall warning varies with the Mach, and experience has shown that it can easily be reached in cruise phase if the aeroplane enters a zone of moderate turbulence. In these cases, the warnings are triggered by a local increase in the angle of attack; they are therefore transient and are generally expressed as truncated warnings (a synthesised voice sounds saying "STALL, STALL", sometimes incompletely). Previous events that have been studied (stall warning triggered in the context of a speed anomaly at cruise speed) show, however, that other crews have not reacted as expected to the proximity of the stall and had a tendency to consider the warning as spurious. For this reason, the behaviour of the AF 447's crew should be considered as liable to be reproduced as regards the lack of reaction to the STALL 1 warning.

These incidents are thus transient phenomena which only trigger a warning because the normal law protections are lost. They generate stress, but despite this the only conclusion that can be reached is that flight safety is not compromised, in any case as long as the flight conditions (airspeed, pitch attitude, thrust) are maintained. It would therefore appear that, under these conditions, the purposeful and immediate reaction of the crew that this warning ought to generate is not necessary; such spurious triggering may be considered as inappropriate and likely to impair the overall credibility of a warning which is almost never encountered by crews during type rating, in flight or during training.

Furthermore, in alternate or direct laws as featured in the manufacturer's manual (FCOM), the stall warning is described as being the combination of the aural warning, the illumination of the Master Warning light on the FCU and the indication on the speed tape, displayed as a red and black strip (Vsw). No clear mention of the buffet phenomenon is ever made. However, illumination of the Master Warning generally occurs for a different reason. In the absence of any Vsw display on the PFD speed tape, only the aural warning is unambiguous. The salience of an aural warning not reiterated visually in symbolic form, on a very "visual" aeroplane, is doubtless insufficient. However, irrespective of the ergonomics of the warning, it is likely that the presentation of information that provides an overview of the aeroplane's situation (angle of attack, energy balance (kinetic and potential), flight envelope) would help pilots to "make sense" of the warning and to take the appropriate corrective action in time.

To summarise, the following factors tend to diminish the performance expected from many crews:

- ❑ Minimal exposure during type rating and no exposure during recurrent training (theoretical and practical) to the stall phenomenon, to the stall warning, to buffet and to the application of the associated procedure;
- ❑ The lack of any description of the functioning of the stall warning (a structure diagram or indications of threshold levels, for example) in the documentation;
- ❑ Insufficient awareness of the proximity of the stall angle of attack when cruising at high altitude, a possible consequence of insufficient understanding of the principles of flying at high altitudes and/or the unsuitability of the training;

- ❑ The need to detect the loss of the automatic protections and to integrate the consequences of this loss, particularly the fact that the stall warning is then likely to be triggered and that, if it does, it must be taken into consideration;
- ❑ The lack of a suitable visual device; the addition of a visual signal to supplement the audible signal (warning) and the proprioceptive signal (the buffet), would provide the crew with additional information to enable them to “escape” from an erroneous understanding of the situation;
- ❑ The possibility that the FD is presenting handling instructions that are contrary to the expected pilot actions for an approach to stall.

A few seconds after the transition to alternate law, the stall warning sounded briefly, even though the PF’s inputs should have made this warning sound for several seconds. The reason for this is the drop in the measured airspeeds, some of which fell temporarily to below 60 kt, while the angle of attack reached 40°. Furthermore, the drop in measured airspeeds to values of less than 60 kt during the stall caused the repeated activation and deactivation of the warning which may have made it considerably more difficult for the Captain to effectively analyse the situation on his return to the cockpit. However, it was doubtless already too late, given the aeroplane’s conditions at that time, to recover control of it. There can be other conditions where airspeed measurements (severe icing, obstruction by particles) may be disrupted and for which it might be beneficial to have a stall warning permanently in operation.

Until the end of the flight, the angle of attack values changed successively from valid to invalid. Each time that at least one value became valid again, the stall warning re-triggered and each time the angle of attack values were invalid, the warning stopped. Several nose-down inputs caused a drop in the pitch attitude and the angle of attack, whose values then became valid, such that a clear nose-down input resulted in the triggering of the stall warning. It appears that the PF reacted, on at least two occasions, with a nose-up input, whose consequences were an increase in angle of attack, a drop in measured speed and consequently stopping the stall warning. Until the end of the flight, no valid angle of attack value was less than 35°.

2.4 Operational and technical feedback

The investigation revealed that the operator, the manufacturer and the continuing airworthiness authorities had exchanged a great deal of technical information regarding events associated with the icing of Pitot probes by ice crystals. The resulting analysis notably led to the replacement of certain probes, the execution of wind tunnel tests and the issuing of airworthiness directives and memos for the attention of pilots.

The actions undertaken focused on reducing the risk of probe icing through the implementation of technical modifications. However, the concurrent existence of an operational procedure associated with the loss of airspeed information led the operator, the manufacturer and the authorities to consider that the risk was mitigated, as long as there was no significant excursion from the flight path during these known events. Thus, feedback from in-service events made it impossible to consider and analyse in advance the repeated failure to apply the unreliable airspeed / “Vol avec IAS douteuse” procedure. As discussed in the section on crew training, the multitude of failure scenarios that can result in a loss of speed

information complicates the analysis for the crew, and makes it difficult to provide both exhaustive training and an effective mechanised approach to the application of the procedure. The type of scenario produced and the formulation of the memory items made it difficult to associate the manoeuvre with the situations encountered in in-flight situations. Consequently, although technically adequate, the details of the procedure continue to be understood to differing degrees by crews, who do not always consider their application necessary, and even sometimes consider them to be inappropriate at high altitude.

Although the certification of an aeroplane is based on the principle that a crew does not have exceptional skills, and has followed an appropriate training programme, no method is defined that would make it possible to define or verify the true appropriateness of a training programme. The (J)OEB evaluations conducted during the certification of the A330 did not result in the issuing of a training programme specific to this failure condition. Furthermore, this evaluation does not have a mandatory status.

In-flight experience thus made it possible to find a technical solution for reducing the risk of occurrence of a failure (modification of the probes). It did not, however, identify the fact that the operational aspects involved in the failure constituted a risk factor that had to be integrated.

Operational procedures nevertheless remain a key element in attenuating risks and a means of defence against human errors. It is however a fact that the level of detail and comprehension of procedures is an open issue. Specifically, standard operational procedures are not always followed or applied (for numerous reasons). Pilots may thus not be prepared for unexpected or unusual situations due to:

- Procedures that are inappropriate to situations;
- A workload that makes it impossible to apply procedures;
- Procedures that are too numerous or too detailed.

In addition, a certain number of incidents are not reported in a way that is directly useable by aircrews, and only later analysis of the recorded data made it possible to bring to light the safety aspects. The frequent lack of any immediate testimony or CVR recording, which is the direct consequence of imprecise notification on the part of crews, makes it difficult for the incident to be analyzed by safety liaison officer or the investigative authority, and thus improve safety. The same applies to the systematic operational analysis of human factors that should be undertaken by the manufacturer. Thus, though the quality process works in theory, in reality it is sometimes a failure. This non-optimal situation, even where identified by the authority, would give rise to no notifications, the process being acceptable from the regulatory perspective. What is more, the large number of ASR's received by the authority, with a very variable level of severity, does not help sort them in terms of their relevance and thus renders their handling more uncertain.

2.5 Oversight of the Operator by the national aviation safety authority (DGAC/DSAC)

Mastery of safety mainly depends on processes (pro-active or reactive) that are developed, implemented and followed up by operators: flight crew incident reports, subsequent analysis of flight data and incidents, monitoring trends, etc. Oversight undertaken by the authority over operators is essentially regulatory: only the operators' compliance with the requirements in force is checked. The authority also ensures, where possible, that the operator uses procedures that will identify any possible safety issues and remedy them. Since 1st January 2012, these processes have been integrated into the new regulatory context of the Safety Management System, which specifically permits the Authority and the operator to go beyond uniquely prescriptive regulatory requirements.

The programmed and unscheduled inspections, on the ground and in flight, are undertaken by different entities (PEPN on the one hand, OCV on the other). Their statutes are different but the number of inspections performed in one year is limited and has to involve all French operators. The proportion of the total number of inspections by the number of flight legs varies considerably according to the operator. For comparison, an airline operating five long-haul aeroplanes will be subject to about two inspections a year for 2,000 flights, whereas Air France, which has a fleet of that is more varied and extensive, will be subject to 80 inspections a year for 350,000 flights. The ratio of 1/1,000 for others is here reduced to 1/4,000. In this context, the probability of discovering deviations, even those that are purely regulatory, is greatly reduced for an airline like Air France. The level of individual performance is however extremely difficult to demonstrate, and thus to correct. In fact, in case of an inspection, even unscheduled, crews know what is expected of them and generally manage to avoid behaving in such a way as to show: deviations from standard procedures, poor quality of communication or teamwork, etc. The variable conditions of a check flight (weather, load, departure and arrival aerodromes) can, in addition, can lead to differing judgments as to the quality of the flight crew.

At the time of the accident, the in-flight inspections, the only ones capable of detecting weaknesses in a crew, that were undertaken by the authority had not been the subject of any specific comments to Air France. However, an internal safety report that was undertaken by Air France after some events and accidents, revealed the following:

- The "situational awareness", "decision-making" and "crew resource management" causal factors were inseparable and were by far the most significant contributing factor in many events;
- The piloting abilities of long-haul and/or ab-initio pilots were sometimes poor;
- A notable loss of good sense and general aeronautical knowledge;
- Weaknesses in terms of representation and awareness of the situation during system failures (reality, severity, danger level, induced effects ...).

The problem described above is accentuated by the lack of cohesion and synergy created by the current organisation, which leads to two separate entities within the DGAC to undertake the in-flight inspections while belonging to two different hierarchical structures. Further, the initial and recurrent training of some inspectors, associated for some with limited professional experience, makes it more difficult to detect the weaknesses of an operator and to evaluate its level of safety performance.

2.6 SAR operations

The accident occurred at 2 h 14 min 28 in the ATLANTICO FIR. It is useful to bear in mind that the last radio transmission between the aeroplane and the ATLANTICO ACC took place at 1 h 35 min. A contact should have occurred at around 2 h 20 when passing the TASIL point. The first ALERFA/INCERFA message was transmitted by the Madrid ACC at 8 h 22. Thus approximately 6 hours had gone by between the last message expected from the crew and the transmission of the first message triggering the uncertainty phase. It was only at 11 h 04 min and 12 h 14 min respectively that Brazilian and Senegalese aeroplanes took off heading to 2 different search areas.

During flyover of remote or maritime areas, as was the case for flight AF 447, the key witness of an event is the air traffic control body in charge of the flight. The recurrence of communication problems in HF combined with the heavy traffic in this area and at that time did however mean the critical situation was accepted, the air traffic controllers often being confronted with this loss of radio contact. That was how this situation was treated as normal and did not lead to questioning and through this to the rapid triggering of incerfa, alerfa or detresfa type urgency phases, prior to any action by SAR services.

The operator became aware of the failure messages issued by the aeroplane and informed the French search and rescue authorities, also informing them of the last known position of the aeroplane. These authorities then considered themselves not competent to intervene in a zone outside their area of responsibility. This could be explained by ineffective training for the SAR agents, particularly in terms of coordination with foreign counterparts. Furthermore the latter lacked the resources that would have enabled rapid and effective action. Thus, even if the possibility of an accident had been taken into account individually, the searches for information were not coordinated, making each service (air traffic control, SAR, operator) in several countries involved question each other without any real decision for action being taken.

In addition, information about the aeroplane's last known position was not transferred or transmitted to a Brazilian or Senegalese SAR centre. The absence of means of detection (no radar coverage) and information (failure of ADS connections) did not make it possible for any objective responses to be provided during the search for flight AF 447. The radio communication problems and the meteorological conditions formed confirmation biases for considering the situation as normal.

Once the critical phases were triggered and the rescue coordination centres were warned of a possible accident, the latter wasted considerable time gathering information and taking into account the necessity of triggering searches.

The absence of an SAR protocol between Senegal and Brazil meant that the air resources available in each country were not known quickly (like the Bréguet Atlantic 2 in DAKAR), nor was it possible to rapidly determine a single ARCC in charge of coordinating the SAR mission.

2.7 Radio-communications with control services

2.7.1 Controllers' and crew's planned actions

Before entry into ATLANTICO FIR, the controller of the Recife ACC asked the crew to contact DAKAR Oceanic ACC after TASIL point. This practice enabled the crew to leave ATLANTICO FIR even in the event of loss of HF radio contact, which must have been quite common. The crew of flight AF 447, in these conditions, probably considered that it was not necessary to make other position reports before TASIL. The crew was doubtless counting on a SELCAL call from the controller of Atlantico ACC in case of need after passing INTOL point.

The controller of ATLANTICO ACC could have expected to receive position reports from the crew when they passed SALPU and ORARO points. Because of the bad quality of the HF noted on that day, he was not surprised by this and he doubtless did not make the call via SELCAL, considering that he would not, in those conditions, receive an answer.

This lack of radio contacts was likely interpreted as normal by all those involved. It contributed to making the controller lose awareness of flight AF 447. The relieving of the ATLANTICO ACC controller shortly before the expected exit of Atlantico FIR may have reinforced this loss of awareness.

The lack of contact between the ATLANTICO ACC controller and the crew before the transfer to Dakar oceanic ACC, then the lack of contact between the Dakar oceanic ACC controller and the Atlantico ACC controller after the estimated passage of the TASIL point meant that flight AF 447 was not monitored effectively.

2.7.2 Limits on the use of the Eurocat system in Senegal

The Eurocat system was installed in the operations room while it was being assessed in an experimental context in Senegal. In fact, on the day of the event it was partly replacing the system in place. It was not accompanied by training for all the controllers on duty, or with user guidelines. The specifics of its use were consequently poorly understood.

A failure to detect an error in the formatting of a flight plan in the Eurocat system made it impossible for the crew to establish a satellite connection with a view to a position report by ADS-C, or exchanges by CPDLC.

This ambiguous use of a non-operational system in a control room encouraged the creation of a representation of flight AF 447 in the Dakar centre with no connection with its real position. This situation distanced the controller from monitoring his traffic.

However, a simulation of the flight that was undertaken in the context of the investigation showed that ADS-C connection would likely have alerted the controller as soon as there was a loss of altitude generated by the loss of Mach (330 feet).

2.7.3 Alert service provision

The presence of ADS-C capabilities in Brazil and in Senegal offered controllers the potential to regain awareness of the flight. These capacities were not exploited by the crew (during transit in ATLANTICO FIR), by Brazil, or by Senegal (in experimental phase) for flight AF 447.

The Atlantico ACC controller considered that the DAKAR Oceanic ACC controller would call him in the event of absence of contact with flight AF 447, 3 minutes after the expected entry time into his FIR. The Dakar controller however was waiting for the controller of Sal ACC to inform him of the entry of flight AF 447 into his FIR. These strategies of deferring information led in fact to the suspension of the alert service in each of these FIRs, thus compromising the triggering of alerts within appropriate timeframes. Questioning Sal controllers, who had radar, did not make it possible to regain effective monitoring of the flight.

2.8 Lessons learnt from the search for the wreckage of flight AF 447

The absence of data on sea surface currents measured in-situ at the start of, and then during the search and rescue operations, was detrimental to the effectiveness of the subsequent determination of the search strategies. The lack of reliable measured information in this area of the Atlantic Ocean affected the accuracy of the reverse-drift calculation tools, which contributed towards increasing the uncertainties inherent to this type of simulation.

This work demonstrated that it is important to quickly have access to data on sea surface currents measured in-situ. If the first aircraft to arrive at the zone after the accident had released drifting buoys, which could have been monitored by satellite, then this data would have facilitated the localisation of the accident site.

3 - CONCLUSION

3.1 Findings

- ❑ The crew possessed the licenses and ratings required to undertake the flight.
- ❑ The aeroplane possessed a valid Certificate of Airworthiness, and had been maintained in accordance with the regulations.
- ❑ The aeroplane's weight and balance were within operational limits.
- ❑ The aeroplane had taken off from Rio de Janeiro without any known technical problems, except on one of the three radio management panels.
- ❑ The composition of the crew was in accordance with the operator's procedures.
- ❑ The meteorological situation was not exceptional for the month of June in the inter-tropical convergence zone.
- ❑ There were powerful cumulonimbus clusters on the route of AF 447. Some of them could have been the centre of some notable turbulence.
- ❑ An additional meteorological analysis showed the presence of strong condensation towards AF 447's flight level, probably associated with convection phenomena.
- ❑ The precise composition of the cloud masses above 30,000 feet is little known, in particular with regard to the super-cooled water/ice crystal divide, especially with regard to the size of the latter.
- ❑ Several aeroplanes that were flying before and after AF 447, at about the same altitude, altered their routes in order to avoid cloud masses.
- ❑ The crew had identified some returns on the weather radar and made a heading change of 12° to the left of their route.
- ❑ At the time of the autopilot disconnection, the Captain was taking a rest.
- ❑ The departure of the Captain was done without leaving any specific instructions for crossing the ITCZ.
- ❑ There was an implicit designation of a pilot as relief Captain.
- ❑ There was an inconsistency between the speeds measured, likely following the blockage of the Pitot probes by ice crystals.
- ❑ The AP then the A/THR disconnected while the aeroplane was flying at the upper limit of a slightly turbulent cloud layer.
- ❑ The aeroplane systems detected an inconsistency in the measured airspeeds. The flight control law was reconfigured to alternate 2B.
- ❑ No failure message on the ECAM clearly indicates the detection by the system of an inconsistency in measured airspeeds.
- ❑ The pilots detected an anomaly through the autopilot disconnection warning that surprised them.

- ❑ Although having identified and called out the loss of the airspeed indications, neither of the two copilots called the “Unreliable IAS” procedure.
- ❑ The Flight Directors did not disconnect.
- ❑ The crossbars disappeared and then re-appeared on several occasions, changing mode several times.
- ❑ The copilots had not undertaken any in-flight training, at high altitude, for the “vol avec IAS douteuse” procedure or on manual aeroplane handling.
- ❑ The speed displayed on the left PFD was incorrect for 29 seconds, that of the speed on the ISIS for 54 seconds and the speed displayed on the right PFD for 61 seconds at most.
- ❑ In less than one minute after autopilot disconnection, the aeroplane exited its flight envelope following inappropriate pilot inputs.
- ❑ The Captain came back into the cockpit about 1 min 30 after the autopilot disconnection.
- ❑ Throughout the flight, the movements of the flight control surfaces were consistent with the pilot’s inputs.
- ❑ Up to the exit from the flight envelope, the aeroplane’s movements were consistent with the position of the flight control surfaces.
- ❑ There is no regulatory CRM training for a crew made up of two copilots in a situation with a relief Captain.
- ❑ The approach to stall was characterised by the triggering of the warning then the appearance of buffet.
- ❑ In the absence of a display of the limit speeds on the speed tape on the PFD, the aural stall warning is not confirmed by any specific visual display.
- ❑ The stall warning sounded continuously for 54 seconds.
- ❑ Neither of the pilots made any reference to the stall warning or to buffet.
- ❑ A short time after the triggering of the stall warning, the PF selected TO/GA thrust and made a nose-up input.
- ❑ Neither of the pilots formally identified the stall situation.
- ❑ The theoretical training undertaken by the copilots, as well as some documents, including the OSV note, associated the buffet phenomenon with the approach to stall as well as to overspeed. On the Airbus A330, the buffet phenomenon is only encountered on the approach to stall.
- ❑ The angle of attack is the parameter that allows the stall warning to be triggered; if the angle of attack values become invalid, the warning stops.
- ❑ By design, when the measured speed values are lower than 60 kt, the measured angle of attack values are invalidated.
- ❑ Each time that the stall warning triggered, the angle of attack exceeded the value of its theoretical trigger threshold.
- ❑ The aeroplane’s angle of attack is not directly displayed to the pilots.

- ❑ The engines functioned normally and always responded to the crew's inputs.
- ❑ The PNF called out imprecise flight path corrections. They were however essential and sufficient for short-term management of the situation.
- ❑ The last recorded values were a pitch attitude of 16.2 degrees nose-up, roll of 5.3 degrees to the left and a vertical speed of -10,912 ft/min.
- ❑ The Pitot probes installed on F-GZCP met requirements that were stricter than the certification standards.
- ❑ Analysis of the events related to the loss of airspeed indications had led Airbus and Air France to replace C16195AA Pitot probes by the C16195BA model. The first aeroplane had been modified on 30 May 2009.
- ❑ EASA had analyzed Pitot probe icing events; it had confirmed the severity of the failure and had decided not to make the probe change mandatory.
- ❑ The flight was not transferred between the Brazilian and Senegalese control centres.
- ❑ Between 8 h 22 and 9 h 09, the first emergency alert messages were sent by the Madrid and Brest control centres.
- ❑ The crew was not able to use the ADS-C and CPDLC functions with DAKAR Oceanic. If the connection had been established, the loss of altitude would have generated an alert on the controller's screen.
- ❑ The first floating aeroplane parts were found 5 days after the accident.
- ❑ The flight recorders were recovered 23 months after the accident.

3.2 Causes of the Accident

The obstruction of the Pitot probes by ice crystals during cruise was a phenomenon that was known but misunderstood by the aviation community at the time of the accident. From an operational perspective, the total loss of airspeed information that resulted from this was a failure that was classified in the safety model. After initial reactions that depend upon basic airmanship, it was expected that it would be rapidly diagnosed by pilots and managed where necessary by precautionary measures on the pitch attitude and the thrust, as indicated in the associated procedure.

The occurrence of the failure in the context of flight in cruise completely surprised the pilots of flight AF 447. The apparent difficulties with aeroplane handling at high altitude in turbulence led to excessive handling inputs in roll and a sharp nose-up input by the PF. The destabilisation that resulted from the climbing flight path and the evolution in the pitch attitude and vertical speed was added to the erroneous airspeed indications and ECAM messages, which did not help with the diagnosis. The crew, progressively becoming de-structured, likely never understood that it was faced with a "simple" loss of three sources of airspeed information.

In the minute that followed the autopilot disconnection, the failure of the attempts to understand the situation and the de-structuring of crew cooperation fed on each other until the total loss of cognitive control of the situation. The underlying behavioural hypotheses in classifying the loss of airspeed information as "major" were not validated in the context of this accident. Confirmation of this classification thus

supposes additional work on operational feedback that would enable improvements, where required, in crew training, the ergonomics of information supplied to them and the design of procedures.

The aeroplane went into a sustained stall, signalled by the stall warning and strong buffet. Despite these persistent symptoms, the crew never understood that they were stalling and consequently never applied a recovery manoeuvre. The combination of the ergonomics of the warning design, the conditions in which airline pilots are trained and exposed to stalls during their professional training and the process of recurrent training does not generate the expected behaviour in any acceptable reliable way.

In its current form, recognizing the stall warning, even associated with buffet, supposes that the crew accords a minimum level of “legitimacy” to it. This then supposes sufficient previous experience of stalls, a minimum of cognitive availability and understanding of the situation, knowledge of the aeroplane (and its protection modes) and its flight physics. An examination of the current training for airline pilots does not, in general, provide convincing indications of the building and maintenance of the associated skills.

More generally, the double failure of the planned procedural responses shows the limits of the current safety model. When crew action is expected, it is always supposed that they will be capable of initial control of the flight path and of a rapid diagnosis that will allow them to identify the correct entry in the dictionary of procedures. A crew can be faced with an unexpected situation leading to a momentary but profound loss of comprehension. If, in this case, the supposed capacity for initial mastery and then diagnosis is lost, the safety model is then in “common failure mode”. During this event, the initial inability to master the flight path also made it impossible to understand the situation and to access the planned solution.

Thus, the accident resulted from the following succession of events:

- ❑ Temporary inconsistency between the airspeed measurements, likely following the obstruction of the Pitot probes by ice crystals that, in particular, caused the autopilot disconnection and the reconfiguration to alternate law;
- ❑ Inappropriate control inputs that destabilized the flight path;
- ❑ The lack of any link by the crew between the loss of indicated speeds called out and the appropriate procedure;
- ❑ The late identification by the PNF of the deviation from the flight path and the insufficient correction applied by the PF;
- ❑ The crew not identifying the approach to stall, their lack of immediate response and the exit from the flight envelope;
- ❑ The crew’s failure to diagnose the stall situation and consequently a lack of inputs that would have made it possible to recover from it.

These events can be explained by a combination of the following factors:

- ❑ The feedback mechanisms on the part of all those involved that made it impossible:
 - To identify the repeated non-application of the loss of airspeed information procedure and to remedy this,
 - To ensure that the risk model for crews in cruise included icing of the Pitot probes and its consequences;

- ❑ The absence of any training, at high altitude, in manual aeroplane handling and in the procedure for *"Vol avec IAS douteuse"*;
- ❑ Task-sharing that was weakened by:
 - Incomprehension of the situation when the autopilot disconnection occurred,
 - Poor management of the startle effect that generated a highly charged emotional factor for the two copilots;
- ❑ The lack of a clear display in the cockpit of the airspeed inconsistencies identified by the computers;
- ❑ The crew not taking into account the stall warning, which could have been due to:
 - A failure to identify the aural warning, due to low exposure time in training to stall phenomena, stall warnings and buffet,
 - The appearance at the beginning of the event of transient warnings that could be considered as spurious,
 - The absence of any visual information to confirm the approach-to-stall after the loss of the limit speeds,
 - The possible confusion with an overspeed situation in which buffet is also considered as a symptom,
 - Flight Director indications that may led the crew to believe that their actions were appropriate, even though they were not,
 - The difficulty in recognizing and understanding the implications of a reconfiguration in alternate law with no angle of attack protection.

4 - SAFETY RECOMMENDATIONS

Note: In accordance with Article 17.3 of European Regulation (EU) 996/2010 of the European Parliament and Council of 20 October 2010 on the investigation and prevention of accidents and incidents in civil aviation, a safety recommendation shall in no case create a presumption of blame or liability for an accident, a serious incident or an incident. The addressee of a safety recommendation shall inform the safety investigation authority which issued the recommendation of the actions taken or under consideration, under the conditions described in Article 18 of the aforementioned Regulation.

On the basis of the first findings from the investigation, the BEA issued the following recommendations in its Interim Reports N°2 and 3:

4.1 Recommendations from Interim Report n°2

4.1.1 Flight Recorders

The investigation into the accident to AF 447 confirms the importance of data from the flight recorders in order to establish the circumstances and causes of an accident and to propose safety measures that are substantiated by the facts. As in other investigations, it also brings to light the difficulties that can be encountered in localizing, recovering and reading out the recorders after an accident in the sea.

These difficulties raise questions about the adequacy of the means currently in use on civil transport aircraft for the protection of flight data with the technological possibilities and the challenges that some accidents represent, in particular those that occur over the sea. In the context of this investigation, the BEA thus formed an international working group in order to examine the various techniques that can be employed to safeguard flight data and/or to facilitate localisation of the wreckage and recovery of the flight recorders. This working group dedicated itself to analyzing each field as completely as possible, from the transmission of flight data by satellite to new ULB technologies and it settled on three additional areas for significant improvements in safety: increasing the transmission time and range of the ULB beacons, the sending of data on initialisation and the installation of deployable recorders. This work was presented on 19 November 2009 to the ICAO Air Navigation Commission.

On the basis of this work, the BEA recommends that EASA and ICAO:

- **extend as rapidly as possible to 90 days the regulatory transmission time for ULB's installed on flight recorders on aeroplanes performing public transport flights over maritime areas;**
- **make it mandatory, as rapidly as possible, for aeroplanes performing public transport flights over maritime areas to be equipped with an additional ULB capable of transmitting on a frequency (for example between 8.5 kHz and 9.5 kHz) and for a duration adapted to the pre-localisation of wreckage;**
- **study the possibility of making it mandatory for aeroplanes performing public transport flights to regularly transmit basic flight parameters (for example position, altitude, speed, heading).**

In addition, the BEA recommends that ICAO:

- **ask the FLIRECP group to establish proposals on the conditions for implementing deployable recorders of the Eurocae ED-112 type for aeroplanes performing public transport flights.**

4.1.2 Certification

Examination of reported UAS events in cruise has shown that the majority of them occurred outside of the envelope defined in Appendix C. In fact, the certification criteria are not representative of the conditions that are really encountered at high altitude, for example with regard to temperatures. In addition, it appears that some elements, such as the size of the ice crystals within cloud masses, are little known and that it is consequently difficult to evaluate the effect that they may have on some equipment, in particular the Pitot probes. In this context, the tests aimed at the validation of this equipment do not appear to be well-adapted to flights at high altitude.

Consequently, the BEA recommends that EASA:

- **undertake studies to determine with appropriate precision the composition of cloud masses at high altitude;**

and

- **in coordination with the other regulatory authorities, based on the results obtained, to modify the certification criteria.**

4.2 Recommendations from Interim Report n°3

4.2.1 Recommendations on Operations

Training for Manual Aircraft Handling

The investigation brought to light weaknesses in the two copilots: the inappropriate inputs by the PF on the flight controls at high altitude were not noted by the PNF through an absence of effective monitoring of the flight path. The stall warning and the buffeting were not identified either. This was probably due to a lack of specific training, although in accordance with regulatory requirements. Manual aeroplane handling cannot be improvised and requires precision and measured inputs on the flight controls. There are other possible situations leading to autopilot disconnection for which only specific and regular training can provide the skills necessary to ensure the safety of the flight. Examination of their last training records and check rides made it clear that the copilots had not been trained for manual aeroplane handling of approach to stall and stall recovery at high altitude.

Consequently, the BEA recommends:

- **that EASA review the content of check and training programmes and make mandatory, in particular, the setting up of specific and regular exercises dedicated to manual aircraft handling of approach to stall and stall recovery, including at high altitude.**

Relief Captain

Taking into account the planned length of the flight, the flight crew was augmented by a copilot to allow for rest during the flight. The investigation showed that the Captain left to take his rest without having clearly nominated the PF as his relief. The flight crew consisting of two copilots thus inherited a certain strategic vagueness after his departure, which was reinforced by a lack of training adapted to crews made up of two copilots and to the exercise of the task of relief Captain. Though the distribution of roles between the two copilots probably did not seem ambiguous to them, it did nevertheless pose a problem. In fact, the rationale can be questioned for designating the copilot (PF) as relief Captain, as his overall experience and on type was much lower than that of the second copilot (PNF), who was also an officer of the airline's OCC and thus more likely to be accorded a certain level of recognition.

Consequently, the BEA recommends:

- **that EASA define additional criteria for access to the role of relief Captain so as to ensure better task-sharing in case of augmented crews;**

and

- **that, provisionally, the DGAC define additional criteria for access to the role of relief Captain so as to ensure better task-sharing in case of augmented crews.**

4.2.2 Recommendation relating to Certification

Angle of Attack Measurement

The crew never formally identified the stall situation. Information on angle of attack is not directly accessible to pilots. The angle of attack in cruise is close to the stall warning trigger angle of attack in a law other than normal law. Under these conditions, manual handling can bring the aeroplane to high angles of attack such as those encountered during the event. It is essential in order to ensure flight safety to reduce the angle of attack when a stall is imminent. Only a direct readout of the angle of attack could enable crews to rapidly identify the aerodynamic situation of the aeroplane and take the actions that may be required.

Consequently, the BEA recommends:

- **that EASA and the FAA evaluate the relevance of requiring the presence of an angle of attack indicator directly accessible to pilots on board aeroplanes.**

4.2.3 Recommendations relating to Flight Recorders

Analysis of the FDR parameters and audition of the CVR provide information that is essential to an understanding of the event. However, it is difficult to reconstruct the indications that were available to the crew on their instrument panel, especially the instructions given by the Flight Director crossbars when they reappear. It is also impossible to see whether there have been any attempts to re-engage the autopilot. A view of the instrument panel would complete the information provided by the FDR and the CVR and would make it possible to confirm the indications that were

available to the crew and the actions that they made. Numerous recommendations have already been made on this subject over the past ten years without any real progress having been made.

Consequently, the BEA again recommends:

- **that ICAO require that aircraft undertaking public transport flights with passengers be equipped with an image recorder that makes it possible to observe the whole of the instrument panel;**

and

- **that at the same time, ICAO establish very strict rules for the readout of such recordings in order to guarantee the confidentiality of the recordings.**

Today, the regulation requires recording of the flight parameters displayed on the left side. Some parameters essential to the analysis of the conduct of the flight are lacking, in particular those displayed to the pilot in the right seat: speed, altitude, attitudes, position of the flight director crossbars, etc. In addition, aeroplanes are equipped with complex systems whose functional analysis is limited and delayed by the absence of a recording of all of the data sources that they use.

Consequently, the BEA recommends:

- **that EASA and the FAA make mandatory the recording:**
 - **of the position of the flight director crossbars,**
 - **of the parameters relating to the conduct of the flight displayed on the right side, in addition to those displayed on the left side;**

and

- **that EASA and the FAA evaluate the relevance of making mandatory the recording of the air data and inertial parameters of all of the sources used by the systems.**

4.2.4 Recommendations relating to Transmission of Flight Data

In its Interim Report n°2, the BEA issued safety recommendations on increasing the duration and the range of Underwater Locator Beacon (ULB)'s, regular transmission of data and the installation of deployable recorders. These recommendations were based on the conclusions of an international government-industry working group led by the BEA in the framework of the safety investigation into the accident to flight AF 447, which has since studied the feasibility of triggered transmission of flight data. This concept consists of real time analysis of onboard flight parameters in order to detect emergency situations. In these cases, the transmission of flight data is triggered to facilitate the localisation of an aeroplane in an emergency situation. The results of the working group show that it is technically feasible to define reliable criteria based on flight parameters allowing emergency situations to be detected, while limiting false alarms. The group also concluded that it is technically feasible to obtain an impact position with enough precision, even in case of accidents where the aeroplane is in an unusual position. In addition, the group work showed that the in-flight activation of new generation ELT's using the same emergency detection criteria is feasible, thus allowing localisation of wreckage to within 5 km.

On the basis of this work, the BEA recommends:

- **that EASA and ICAO make mandatory as quickly as possible, for aeroplanes making public transport flights with passengers over maritime or remote areas, triggering of data transmission to facilitate localisation as soon as an emergency situation is detected on board;**

and

- **that EASA and ICAO study the possibility of making mandatory, for aeroplanes making public transport flights with passengers over maritime or remote areas, the activation of the emergency locator transmitter (ELT), as soon as an emergency situation is detected on board.**

4.3 New Recommendations

4.3.1 SAR coordination plans over maritime and remote areas

Those responsible for Brazilian SAR stated that they did not know what means were available in the neighbouring SAR areas and had not tried to obtain information on the subject. Contrary to ICAO standards and recommended practices, there is no SAR coordination plan between Brazil and Senegal. This lack of a plan caused a considerable delay in the start of SAR operations.

Consequently, the BEA recommends that:

- **ICAO ensure the implementation of SAR coordination plans or regional protocols covering all of the maritime or remote areas for which international coordination would be required in the application of SAR procedures, including in the South Atlantic area. [Recommendation FRAN-2012-032]**

4.3.2 Training of SAR operators

The practices observed in the MRCC showed that any doubt induces a formalised SAR response. Although informed by the operator, the French ARCC did not take adequate steps to formalise the implementation of SAR, restricting itself to their zone of responsibility. The training courses undertaken by the ARCC and MRCC personnel rely heavily on the experience within these centres. There is no formalised and common training specific to the SAR mission.

Consequently, the BEA recommends that:

- **the DGAC, in concert with the other services responsible, develop a homogeneous framework for training and for approval of operators responsible for search and rescue activities in France; [Recommendation FRAN-2012-033]**
- **ICAO define the framework for the training of SAR operators in its standards and recommended practices. [Recommendation FRAN-2012-034]**

4.3.3 Organisation of SAR in France

The investigation showed a lack of coordination within the French ARCC. In addition, the absence of a central ARCC in France led the operator to contact several organisations and to provide key information to organisations not competent in SAR. The latter did not pass on this information (in particular the last known position of the aeroplane contained in an ACARS message).

Further, the MRCC have documents listing the MRCC's of all countries, their national points of contact with their coordinates, as well as the ARCC's and JRCC's.

Consequently, the BEA recommends that:

- **the DGAC designate a point of contact at ICAO for the ARCC that has adequate means to accomplish his/her missions; [Recommendation FRAN-2012-035]**
- **ICAO ensure each Member State has a national point of contact and makes his/her contact information available. [Recommendation FRAN-2012-036]**

4.3.4 Air Traffic Control

The investigation showed that the use of HF as a means of communication between ground and aeroplane is limited. Link outages were frequent in this area, especially on the day of the accident. A simulation of the use of ADS-C and CPDLC functions showed that the loss of altitude would have generated an alert on the DAKAR controller's screen. There are numerous areas in the world where HF remains the only means of communication between ground and aeroplane, though more reliable means are available today.

Consequently, the BEA recommends that:

- **the Brazilian and Senegalese authorities make mandatory the utilisation, by aeroplanes so equipped, of ADS-C and CPDLC functions in the zones in question; [Recommendation FRAN-2012-037]**
- **ICAO request the involved States to accelerate the operational implementation of air traffic control and communication systems that allow a permanent and reliable link to be made between ground and aeroplane in all of the areas where HF remains the only means of communication between the ground and aeroplanes. [Recommendation FRAN-2012-038]**

4.3.5 Initial and recurrent training of pilots

Aeroplane handling in the longitudinal axis in a reconfigured law is in general very similar in sensations and responses to flying in normal law. Nevertheless, exiting the flight envelope can be made possible, without longitudinal pilot inputs, by the total loss of the protections and the absence of positive longitudinal stability. The possible related loss of associated speed references doubtless constitutes an aeroplane handling difficulty for crews that are not prepared. Training does not adequately

draw attention of crews to the precise identification of the type of reconfiguration and of the level of protection and on the necessity to monitor the trajectory and the primary parameters. In general, the complexity of modern aeroplanes and their particularities require appropriate initial and recurrent training courses.

Consequently, the BEA recommends that:

- **EASA ensure the integration, in type rating and recurrent training programmes, of exercises that take into account all of the reconfiguration laws. The objective sought is to make its recognition and understanding easier for crews especially when dealing with the level of protection available and the possible differences in handling characteristics, including at the limits of the flight envelope; [Recommendation FRAN-2012-039]**
- **More generally, EASA ensure that type rating and recurrent training programmes take into account the specificities of the aircraft for which they are designed. [Recommendation FRAN-2012-040]**

After the autopilot disconnection, while the aeroplane was stable in cruise, several pilot inputs significantly degraded the aeroplane's kinetic energy. The rapid exit from the flight envelope was not anticipated by the pilots, nor as it understood. In the absence of any reliable speed indications, understanding of the overall physics of flight at high altitude could have considerably helped the pilots to anticipate the rapid degradation of the situation. The same applies to the overspeed phenomena that have evolved with modern aeroplanes.

Consequently, the BEA recommends that:

- **EASA define recurrent training programme requirements to make sure, through practical exercises, that the theoretical knowledge, particularly on flight mechanics, is well understood. [Recommendation FRAN-2012-041]**

The startle effect played a major role in the destabilisation of the flight path and in the two pilots understanding the situation. Initial and recurrent training as delivered today do not promote and test the capacity to react to the unexpected. Indeed the exercises are repetitive, well known to crews and do not enable skills in resource management to be tested outside of this context. All of the effort invested in anticipation and predetermination of procedural responses does not exclude the possibility of situations with a "fundamental surprise" for which the current system does not generate the indispensable capacity to react.

The rapid increase in crew workload in an unusual and unexpected situation led to the degradation of the quality of communication and coordination between the pilots.

Consequently, the BEA recommends that:

- **EASA review the requirements for initial, recurrent and type rating training for pilots in order to develop and maintain a capacity to manage crew resources when faced with the surprise generated by unexpected situations; [Recommendation FRAN-2012-042]**

- **EASA ensure that operators reinforce CRM training to enable acquisition and maintenance of adequate behavioural automatic responses in unexpected and unusual situations with a highly charged emotional factor. [Recommendation FRAN-2012-043]**

The lack of any reference system and of homogeneity in the instruction methods and evaluation criteria for instructors does not allow an objective evaluation and comparison of CRM skills among crews. This lack could however be compensated for by the existence of a standards for instruction that would allow the implementation of an objective evaluation and comparison of the level of CRM among crews.

Consequently, the BEA recommends that:

- **EASA define criteria for selection and recurrent training among instructors that would allow a high and standardized level of instruction to be reached. [Recommendation FRAN-2012-044]**

4.3.6 Improving flight simulators and exercises

The crew of flight AF 447 did not associate the disappearance of the speed information and the ECAM messages associated with the “Unreliable IAS” procedure. The three crew members had undertaken their training according to a known scenario on the simulator, though the technical limitations of the simulator, whose fidelity is satisfactory in most cases, do not allow certain unusual situations to be simulated.

The demonstrative context of the pedagogical approach does not allow the crew to realize the influence of the startle effect generated by the warnings nor, where applicable, of the inappropriate reflex actions on the controls that can occur as a consequence.

These technical limitations, combined with the absence of specific pedagogical tools, do not guarantee assimilation and maintenance of adequate knowledge making it possible to avoid, identify and recover from such a situation.

Consequently, the BEA recommends that:

- **EASA modify the basis of the regulations in order to ensure better fidelity for simulators in reproducing realistic scenarios of abnormal situations; [Recommendation FRAN-2012-045]**
- **EASA ensure the introduction into the training scenarios of the effects of surprise in order to train pilots to face these phenomena and to work in situations with a highly charged emotional factor. [Recommendation FRAN-2012-046]**

4.3.7 Ergonomics

The crew did not de-activate the flight directors and did not call out any changes in FMA mode. It is not sure that they noticed the appearances and disappearances of the flight director crossbars. It is likely that the crew did not know of the mode changes when the flight director became active again, reading and assimilating the displays

on the FMA in dynamic and stressful conditions not being instinctive or natural. It seems that requiring an action from the crew to re-engage this automatic system would, on the one hand, lead to a consistency with the autopilot and the autothrust, and on the other hand stimulate a check on the modes and the consistency of the commands presented at the time of the re-engagement.

Consequently, the BEA recommends that:

- **EASA require a review of the re-display and reconnection logic of the flight directors after their disappearance, in particular to review the conditions in which an action by the crew would be necessary to re-engage them; [Recommendation FRAN-2012-047]**

Further, even if it is not sure that the crew followed the orders from the flight director while the stall warning was active, the orders from the crossbars were in contradiction with the inputs to make in this situation and thus may have troubled the crew.

Consequently, the BEA recommends that:

- **EASA require a review of the functional or display logic of the flight director so that it disappears or presents appropriate orders when the stall warning is triggered. [Recommendation FRAN-2012-048]**

The failure messages successively displayed on the ECAM did not allow the crew to make a rapid and effective diagnosis of the situation the aeroplane was in, in particular of the blockage of the Pitot probes. They were never in a position to make the connection between the messages that appeared and the procedure to apply, although reading the ECAM and messages should facilitate the analysis of the situation and allow failures to be handled. Several systems had however identified the origin of the problem but only generated failure messages related to the consequences on themselves.

Consequently, the BEA recommends that:

- **EASA study the relevance of having a dedicated warning provided to the crew when specific monitoring is triggered, in order to facilitate comprehension of the situation. [Recommendation FRAN-2012-049]**

The stall warning is described as being a combination of the aural warning, the illumination of the Master Warning light on the FCU and an indication on the red and black speed tape (VSW). However, the illumination of the Master Warning is generally of a different origin. In the absence of the red and black Vsw on the speed tape, the only element that presents the characteristics of clarity and absence of ambiguity on approach to stall is the aural warning. Symbolic visual information combined with an aural warning on an aeroplane on which sight is highly demanded would doubtless improve its perception.

Consequently, the BEA recommends that:

- **EASA determine the conditions in which, on approach to stall, the presence of a dedicated visual indications, combined with an aural warning should be made mandatory. [Recommendation FRAN-2012-050]**

When airspeeds are below 60 kt, the stall warning is no longer available, even though it may be beneficial for it to be available at all times.

Consequently, the BEA recommends that:

- **EASA require a review of the conditions for the functioning of the stall warning in flight when speed measurements are very low. [Recommendation FRAN-2012-051]**

4.3.8 Operational and Technical Feedback

The investigation showed that the certification of an aeroplane does not make it possible to identify all of the operational risks, and that in addition there is no mandatory operational and human factors analysis of in-service events (as with continuing airworthiness). EASA is currently undertaking work (OSD) aimed at having the holder of the aeroplane type certificate define its minimum associated training programme, based on the operational risks identified by operators and the manufacturer following in-service events.

In-service feedback is an essential prerequisite in the process of improving flight safety. It is notable that the reports written by crews after events do not always reveal their severity or all of the elements of an operational appreciation. This makes somewhat random the preservation of the indispensable elements needed for an investigation and thus difficult for the operator, the manufacturer and the authorities to evaluate the associated risks and threats and to undertake an exhaustive analysis that makes it possible to take appropriate measures.

Consequently, the BEA recommends that:

- **EASA improve the feedback process by making mandatory the operational and human factors analysis of in-service events in order to improve procedures and the content of training programmes; [Recommendation FRAN-2012-052]**

and specifically,

- **that the DGAC take steps aimed at improving the relevance and the quality of incident reports written by flight crews and their distribution, in particular to manufacturers. [Recommendation FRAN-2012-053]**

4.3.9 Oversight of the Operator

In-flight and ground inspections by the Authority within the airline never brought to light any major deviations, whether in relation to the operator's conformity to the regulatory provisions, to the ECP's or in flight. Thus, the whole range of inspections did not bring to light the fragile nature of the CRM nor the weaknesses of the two copilots in manual aeroplane handling. Though respecting the regulatory requirements applicable to oversight, it appears that the organisation, methods and means deployed by the authority were not adequate to detect the weaknesses of an operator and impose the necessary corrective measures.

Consequently, the BEA recommends that:

- **the DGAC review the organisation of its oversight so as to improve its cohesion and effectiveness; [Recommendation FRAN-2012-054]**
- **the DGAC ensure the adequacy of the conditions of recruitment and training so that all of its inspectors have the skills required to exercise their functions. [Recommendation FRAN-2012-055]**

4.3.10 Release of Drift Measuring Buoys

The release of drift measuring buoys by the first aircraft to arrive over the zone would have made it possible to better understand the drift of floating debris in the first few hours. This would have facilitated modelling of the currents and thus the reverse-drift calculations to estimate more precisely the localisation of the site.

Consequently, the BEA recommends that:

- **ICAO amend Annex 12 on search and rescue operations so as to encourage Contracting States to equip their search aircraft with buoys to measure drift and to drop them, when these units are involved in the search for persons lost at sea. [Recommendation FRAN-2012-056]**

5 - CHANGES MADE FOLLOWING THE ACCIDENT

5.1 Air France

5.1.1 Aeroplane maintenance and equipment

A330/A340 Pitot probes

- Acceleration in the replacement of Thales "AA" probes by "BA" probes, initiated on 27 April 2009. By 11 June 2009, all the probes had been replaced.
- Following an Airworthiness Directive issued by EASA, replacement of Thales "BA" probes by Goodrich probes in positions 1 and 3, from 4 to 7 August 2009.
- Air France internal decision: replacement of Thales "BA" probes by Goodrich probes in position 2, from 18 January to 8 February 2010.

5.1.2 Modifications to reference systems

Reinforcement of the role of co-pilots

- Modification of rules for relieving the Captain in March 2010: the relief co-pilot is designated by the Captain, he sits on the left side and is PNF.
- Deployment underway of a new decision-making method: the co-pilot speaks first, before the final decision of the Captain (optimisation of decision-making, reinforcing the co-pilot's responsibilities).

Documentation

- Changeover to manufacturer's documentation in English. The B777 division will be the first to be thus equipped in October 2012.

5.1.3 Crew training

Flight simulator training

Additional unreliable airspeed session:

- Summer 2009 (A320, A330/A340).
- Session booklet and briefing: technical reminders, human factors and Threat and Error Management (TEM) aspects.
- Revision of the emergency manoeuvre, on take-off and in cruise phase.
- High altitude flight in alternate law.
- Approach to stall with triggering of STALL warning.
- Landing without airspeed indications.
- Related briefings (all flight crew):
 - Weather radar
 - Ice crystals.
- Alternate Training & Qualification Programme (ATQP) (preliminary version) operational on Airbus A320 since March 2012.

Note: These elements were incorporated into the type ratings

Augmented crews and Relief of Captain

- Creation of a DSAC / airlines working group.
- Definition of new rules.
- Specific mid-term line training session.
- Recurrent training and checking exercises integrated into the triennial.

- Design of an augmented crew self-study module.
- Design of a Captain relief self-study module.

Task-sharing

- Pilot Flying/Pilot Monitoring (PF/PM) effective on Airbus A380 since 2012.

Feedback

- Line Operations Safety Audit (LOSA) implemented.

Organisation

- Creation of the “Innovation and Transformation management”.

5.2 Airbus

Review of the “Unreliable speed indication” procedure

- Flight Operations Telex (FOT) of 9 September 2009 recommending, at the next recurrent training course, a session on the simulator at high altitude in normal and alternate law including:
 - Manual aeroplane handling,
 - Carrying out the UNRELIABLE SPEED INDICATION / ADR CHECK PROC procedure.

5.3 EASA

5.3.1 Certification measures to improve aviation safety

1) Pitot probe obstruction

Review of the in-service data available after the accident, which prompted increased reporting from operators, including events that occurred before and after June 2009, prompted issuance of AD 2009-0195 as a precautionary measure. It prohibits Thales C16195AA probes from being installed on Airbus A330/340 aircraft, and allows only one Thales C16195BA probe in the 3 Pitot positions. The maintenance interval for Pitot cleaning was reduced. In parallel, EASA monitored Airbus test activity, in various icing facilities and in flight tests, in order to gather data on Pitot probe behaviour in ice crystal environments. In addition to the Airbus programmes, a Special Condition is being raised on all new projects, imposing the latest specification material available for Pitot probes.

2) Autopilot reconnection

An Airworthiness Directive (AD 2010-0271) issued by EASA in December 2010 asked crews that found themselves in such a situation to make sure not to re-connect the autopilot before the airspeeds return to values consistent with flight for 30 seconds, due to a risk of pitch runaway that could constitute an “unsafe condition”.

3) Severity of the condition

EASA flight test pilots re-evaluated the effect of multiple Pitot probe blockages in an Airbus simulator. The previous “major” assessment was confirmed

5.3.2 Rulemaking actions from EASA to improve aviation safety:

- Decision N°2009/014/R dated 14 October 2009 updating the European technical specification ETSO C16 for Pitot and Pitot-static tubes. The revision upgrades the

SAE standard with an enhanced test protocol. The Agency is participating in the EUROCAE WG-89 which is working on the preparation of a new ETSO standard for Pitot probes ETSO (in order to amend C16a).

- ❑ Rulemaking task 25.058 “Large Aeroplane Certification Specifications in Super-cooled Large Drop, Mixed phase, and Ice Crystal Icing Conditions” was launched in 2010. The corresponding NPA 2011-03 was published on 21 March 2011 and proposed new certification standards for flight in icing conditions. Flight instrument external probes, including Pitot probes, are required to be designed and installed to operate normally in the new icing environment that includes ice crystal and mixed phase icing conditions. As this rulemaking action is ongoing, the Agency is using a Certification Review Item (CRI) in the meantime; the related Special Condition provides for similar specifications as proposed in the NPA 2011-03 and is applicable to any new type certification application.
- ❑ The Agency is contributing to international research projects aimed at improving knowledge of high altitude icing conditions, in particular in profound convection areas, with the presence of high concentrations of ice crystals. This will be used to further improve the certification specifications in the future. A project was launched by the Agency in 2011; it is referenced as EASA.2011.OP.28 “High IWC-Ice water content of clouds at high altitude”. This project will provide recommendations on the areas to be studied and on the preparation of flight tests to characterise the composition of cloud masses at high altitude.

5.4 Aviation industry actions

Manufacturers, operators, pilots associations and authorities formed a working group to draft an “Aeroplane upset recovery training aid” guide, to optimise both academic and practical training on upset recovery issues.

Among the participants in this project were manufacturers: Airbus, Boeing, Bombardier; airlines: American Airlines, Continental, British Airways, Lufthansa, Qantas, Cathay Pacific, Japan Airlines; and safety authorities: FAA (USA), NTSB (USA), CAA (UK). This manual is regularly reviewed and was updated in 2008.

FAA Advisory Circular (AC120-STALL)

An Advisory Circular (AC) contains information that the FAA considers of major interest to operators. An AC is not a binding regulatory text.

The AC is a good practice guide that gives provides crews with the appropriate tools to respond to stall issues.

The themes include methods and tools to prevent, recognise and recover from a stall. The proposals are for:

- ❑ Advanced theoretical training;
- ❑ Realistic exercises on the simulator based on specific scenarios;
- ❑ Taking into account disengagement of automatic systems;
- ❑ Continuous training at each career stage (initial hiring, new type rating, upgrade to Captain, annual recurrent training);
- ❑ Reinforcement of application of SOP’s and effective CRM by the crew;
- ❑ Practice in the “startle factor”;
- ❑ Use of the “upset recovery training aid” by training centres and operators.

List of Appendices

Appendix 1

CVR Transcript

Appendix 2

FDR Chronology

Appendix 3

Graphs of parameters

Appendix 4

SAR Communications

Appendix 5

Air France "Vol avec IAS douteuse" procedure

Appendix 6

Airbus "Unreliable speed indication" procedure

Appendix 7

Extracts from Air France briefing brochure ("IAS douteuse" exercise)

Appendix 8

« Info OSV » document

Appendix 9

Certification envelope of Pitot probes

Appendix 10

Additional Air France unusual "stall warning" procedure

Appendix 11

Airbus "stall warning" technical supplement

Appendix 12

TEMSI chart

BEA

Bureau d'Enquêtes et d'Analyses
pour la sécurité de l'aviation civile

Zone Sud - Bâtiment 153
200 rue de Paris
Aéroport du Bourget
93352 Le Bourget Cedex - France
T : +33 1 49 92 72 00 - F : +33 1 49 92 72 03
www.bea.aero

